

# **Panel PC 2100**

# **Panel mount devices**

## **User's manual**

Version: **2.02 (July 2024)**  
Order no.: **MAPPC2100-ENG**

**Translation of the original documentation**

## **Publishing information**

B&R Industrial Automation GmbH

B&R Strasse 1

5142 Eggelsberg

Austria

Telephone: +43 7748 6586-0

Fax: +43 7748 6586-26

[office@br-automation.com](mailto:office@br-automation.com)

## **Disclaimer**

All information in this document is current as of its creation. The contents of this document are subject to change without notice. B&R Industrial Automation GmbH assumes unlimited liability in particular for technical or editorial errors in this document only (i) in the event of gross negligence or (ii) for culpably inflicted personal injury. Beyond that, liability is excluded to the extent permitted by law. Liability in cases in which the law stipulates mandatory unlimited liability (such as product liability) remains unaffected. Liability for indirect damage, consequential damage, business interruption, loss of profit or loss of information and data is excluded, in particular for damage that is directly or indirectly attributable to the delivery, performance and use of this material.

B&R Industrial Automation GmbH notes that the software and hardware designations and brand names of the respective companies used in this document are subject to general trademark, brand or patent protection.

Hardware and software from third-party suppliers referenced in this document is subject exclusively to the respective terms of use of these third-party providers. B&R Industrial Automation GmbH assumes no liability in this regard. Any recommendations made by B&R Industrial Automation GmbH are not contractual content, but merely non-binding information for which no liability is assumed. When using hardware and software from third-party suppliers, the relevant user documentation of these third-party suppliers must additionally be consulted and, in particular, the safety guidelines and technical specifications contained therein must be observed. The compatibility of the products from B&R Industrial Automation GmbH described in this document with hardware and software from third-party suppliers is not contractual content unless this has been separately agreed in individual cases; in this respect, warranty for such compatibility is excluded in any case, and it is the sole responsibility of the customer to verify this compatibility in advance.

|  |           |
|--|-----------|
| <b>1 Introduction.....</b>                                       | <b>10</b> |
| 1.1 Manual history.....  | 11        |
| 1.2 Information about this document.....                         | 13        |
| 1.2.1 Organization of notices.....                               | 13        |
| 1.2.2 Guidelines.....  | 13        |
| <b>2 General safety guidelines.....</b>                          | <b>14</b> |
| 2.1 Intended use.....  | 14        |
| 2.2 Protection against electrostatic discharge.....              | 14        |
| 2.2.1 Packaging.....   | 14        |
| 2.2.2 Regulations for proper ESD handling.....                   | 14        |
| 2.3 Regulations and measures.....                                | 15        |
| 2.4 Transport and storage.....                                   | 15        |
| 2.5 Installation.....  | 15        |
| 2.6 Operation.....   | 16        |
| 2.6.1 Protection against contact with electrical parts.....      | 16        |
| 2.6.2 Ambient conditions - Dust, moisture, aggressive gases..... | 16        |
| 2.6.3 Programs, viruses and malicious programs.....              | 16        |
| 2.7 Cybersecurity disclaimer for products.....                   | 17        |
| <b>3 System overview.....</b>                                    | <b>18</b> |
| 3.1 About this user's manual.....                                | 18        |
| 3.2 Description of individual modules.....                       | 19        |
| 3.2.1 System units.....  | 19        |
| 3.2.2 AP9x3 panels.....  | 19        |
| 3.2.3 AP1000 panels.....   | 19        |
| 3.3 Design/Configuration.....                                    | 19        |
| 3.3.1 Configuration.....   | 20        |
| 3.3.2 Order number key.....                                      | 22        |
| 3.4 Overview.....  | 23        |
| <b>4 Technical data.....</b>                                     | <b>25</b> |
| 4.1 Complete system.....   | 25        |
| 4.1.1 Mechanical properties.....                                 | 25        |
| 4.1.1.1 Dimensions.....  | 25        |
| 4.1.1.2 Mounting orientations.....                               | 28        |
| 4.1.1.3 Spacing for air circulation.....                         | 31        |
| 4.1.1.4 Mounting orientations.....                               | 32        |
| 4.1.1.5 Weight specifications.....                               | 33        |
| 4.1.2 Environmental properties.....                              | 34        |
| 4.1.2.1 Temperature specifications.....                          | 34        |
| 4.1.2.2 Humidity.....  | 42        |
| 4.1.2.3 Vibration.....   | 43        |
| 4.1.2.4 Shock.....   | 43        |
| 4.1.2.5 Degree of protection.....                                | 43        |
| 4.1.3 Electrical properties.....                                 | 44        |
| 4.1.3.1 System units - Block diagram.....                        | 44        |
| 4.1.3.2 Power calculation.....                                   | 45        |
| 4.1.4 Device interfaces and slots.....                           | 47        |
| 4.1.4.1 Device interfaces - Overview.....                        | 47        |
| 4.1.4.2 +24 VDC power supply.....                                | 48        |
| 4.1.4.3 Ethernet interfaces.....                                 | 49        |
| 4.1.4.4 USB interfaces.....                                      | 50        |
| 4.1.4.5 CFast slot.....  | 51        |
| 4.1.4.6 Power and reset buttons.....                             | 51        |
| 4.1.4.7 LED status indicators.....                               | 52        |
| 4.1.4.8 IF option slot(IF1, IFx).....                            | 53        |

|  |            |
|--|------------|
| 4.1.5 Features of AP1000 panels.....                                 | 54         |
| 4.1.5.1 Slide-in labels.....   | 54         |
| 4.1.5.2 Key and LED configuration.....                               | 55         |
| 4.1.5.3 USB interface.....   | 58         |
| 4.2 Individual components.....                                       | 59         |
| 4.2.1 System units.....  | 59         |
| 4.2.1.1 5PPC2100.BYxx-000.....                                       | 59         |
| 4.2.2 AP9x3 panels.....  | 62         |
| 4.2.2.1 5AP923.1215-00.....  | 62         |
| 4.2.2.2 5AP923.1505-00.....  | 64         |
| 4.2.2.3 5AP923.1906-00.....  | 66         |
| 4.2.2.4 5AP933.156B-00.....  | 69         |
| 4.2.2.5 5AP933.185B-00.....  | 71         |
| 4.2.2.6 5AP933.215C-00.....  | 73         |
| 4.2.2.7 5AP933.240C-00.....  | 75         |
| 4.2.3 AP1000 panels.....   | 78         |
| 4.2.3.1 5AP1120.0573-000.....  | 78         |
| 4.2.3.2 5AP1151.0573-000.....  | 81         |
| 4.2.3.3 5AP1120.0702-000.....  | 84         |
| 4.2.3.4 5AP1130.0702-000.....  | 86         |
| 4.2.3.5 5AP1130.101D-000.....  | 88         |
| 4.2.3.6 5AP1120.101E-000.....  | 90         |
| 4.2.3.7 5AP1130.101E-000.....  | 92         |
| 4.2.3.8 5AP1120.1043-000.....  | 94         |
| 4.2.3.9 5AP1180.1043-000.....  | 96         |
| 4.2.3.10 5AP1181.1043-000.....                                       | 99         |
| 4.2.3.11 5AP1182.1043-000.....                                       | 102        |
| 4.2.3.12 5AP1120.1214-000.....                                       | 105        |
| 4.2.3.13 5AP1120.121E-000.....                                       | 107        |
| 4.2.3.14 5AP1130.121E-000.....                                       | 109        |
| 4.2.3.15 5AP1130.121E-010.....                                       | 111        |
| 4.2.3.16 5AP1120.1505-000.....                                       | 113        |
| 4.2.3.17 5AP1180.1505-000.....                                       | 115        |
| 4.2.3.18 5AP1181.1505-000.....                                       | 117        |
| 4.2.3.19 5AP1120.156B-000.....                                       | 120        |
| 4.2.3.20 5AP1130.156C-000.....                                       | 123        |
| 4.2.3.21 5AP1130.156C-001.....                                       | 125        |
| 4.2.3.22 5AP1130.185C-000.....                                       | 127        |
| 4.2.3.23 5AP1120.1906-000.....                                       | 129        |
| 4.2.4 Interface options.....   | 132        |
| 4.2.4.1 5ACCIF01.FPCC-000.....                                       | 132        |
| 4.2.4.2 5ACCIF01.FPCS-000.....                                       | 137        |
| 4.2.4.3 5ACCIF01.FPLK-000.....                                       | 141        |
| 4.2.4.4 5ACCIF01.FPLS-000.....                                       | 144        |
| 4.2.4.5 5ACCIF01.FPLS-001.....                                       | 147        |
| 4.2.4.6 5ACCIF01.FPSC-000.....                                       | 150        |
| 4.2.4.7 5ACCIF01.FPSC-001.....                                       | 154        |
| 4.2.4.8 5ACCIF01.FSS0-000.....                                       | 159        |
| 4.2.4.9 5ACCIF01.ICAN-000.....                                       | 163        |
| 4.2.4.10 5ACCIF01.IS00-000.....                                      | 166        |
| 4.2.5 CFast cards.....   | 168        |
| <b>5 Installation and wiring.....</b>                                | <b>169</b> |
| 5.1 Basic information.....   | 169        |
| 5.1.1 Installing a Panel PC with an AP9x3 panel.....                 | 171        |
| 5.1.2 Installing the Automation Panel 1000 with retaining clips..... | 173        |
| 5.1.3 Installing the Automation Panel 1000 with clamping blocks..... | 175        |

|          |   |            |
|----------|---|------------|
| 5.1.4    | Installation information for individual components.....               | 177        |
| 5.1.5    | Replacing the system unit.....  | 178        |
| 5.1.6    | Installing the USB hub.....   | 179        |
| 5.2      | Connecting to the power grid.....                                     | 179        |
| 5.2.1    | Installing the DC power cable.....                                    | 179        |
| 5.2.1.1  | Wiring.....   | 180        |
| 5.2.1.2  | Connecting the power supply to a B&R device.....                      | 180        |
| 5.2.2    | Grounding concept - Functional ground.....                            | 180        |
| 5.3      | Connecting cables.....  | 182        |
| <b>6</b> | <b>Commissioning.....</b>   | <b>183</b> |
| 6.1      | Basic information.....  | 183        |
| 6.2      | Switching on the device for the first time.....                       | 183        |
| 6.2.1    | General information before switching on the device.....               | 183        |
| 6.2.2    | Switching on the device.....  | 183        |
| 6.3      | General instructions about the procedure for temperature testing..... | 184        |
| 6.3.1    | Procedure.....  | 184        |
| 6.3.2    | Evaluating temperatures in Windows operating systems.....             | 184        |
| 6.3.2.1  | Evaluating with the B&R Control Center.....                           | 184        |
| 6.3.2.2  | Evaluating with the BurnInTest tool from PassMark.....                | 185        |
| 6.3.3    | Evaluating temperatures in other operating systems.....               | 187        |
| 6.3.4    | Evaluating the measurement results.....                               | 187        |
| 6.4      | Touch screen calibration.....   | 187        |
| 6.4.1    | Single-touch (analog resistive).....                                  | 187        |
| 6.4.1.1  | Windows 10 IoT Enterprise 2016 LTSB.....                              | 187        |
| 6.4.1.2  | Windows 10 IoT Enterprise 2015 LTSB.....                              | 187        |
| 6.4.1.3  | Windows Embedded 8.1 Industry Pro.....                                | 187        |
| 6.4.1.4  | Windows 7 Professional / Ultimate.....                                | 187        |
| 6.4.1.5  | Windows Embedded Standard 7 Embedded / Premium.....                   | 187        |
| 6.4.2    | Multi-touch (projected capacitive - PCT).....                         | 188        |
| 6.4.2.1  | Windows 10 IoT Enterprise 2016 LTSB.....                              | 188        |
| 6.4.2.2  | Windows 10 IoT Enterprise 2015 LTSB.....                              | 188        |
| 6.4.2.3  | Windows Embedded 8.1 Industry Pro.....                                | 188        |
| 6.4.2.4  | Windows 7 Professional / Ultimate.....                                | 188        |
| 6.4.2.5  | Windows Embedded Standard 7 Premium.....                              | 188        |
| 6.5      | Display brightness control.....                                       | 188        |
| 6.6      | Known problems / Characteristics.....                                 | 189        |
| <b>7</b> | <b>Software.....</b>  | <b>190</b> |
| 7.1      | BIOS options.....   | 190        |
| 7.1.1    | General information.....  | 190        |
| 7.1.2    | BIOS Setup and start procedure.....                                   | 190        |
| 7.1.3    | BIOS default settings.....  | 190        |
| 7.1.4    | BIOS Setup buttons.....   | 191        |
| 7.1.5    | Main.....   | 192        |
| 7.1.5.1  | System information.....   | 192        |
| 7.1.6    | Advanced.....   | 194        |
| 7.1.6.1  | OEM features.....   | 195        |
| 7.1.6.2  | CPU configuration.....  | 202        |
| 7.1.6.3  | Graphics (IGD) configuration.....                                     | 204        |
| 7.1.6.4  | LAN.....  | 206        |
| 7.1.6.5  | PCI express configuration.....  | 207        |
| 7.1.6.6  | USB configuration.....  | 209        |
| 7.1.6.7  | SATA configuration.....   | 210        |
| 7.1.6.8  | Miscellaneous configuration.....                                      | 210        |
| 7.1.6.9  | Thermal configuration.....  | 211        |
| 7.1.7    | Security.....   | 213        |

|  |     |
|--|-----|
| 7.1.8 Boot.....  | 214 |
| 7.1.8.1 Boot device priority.....                      | 214 |
| 7.1.8.2 Boot configuration.....                        | 215 |
| 7.1.9 Exit.....  | 217 |
| 7.1.10 Allocation of resources.....                    | 218 |
| 7.1.10.1 RAM address assignment.....                   | 218 |
| 7.1.10.2 I/O address assignments.....                  | 218 |
| 7.1.10.3 Interrupt assignments in PIC mode.....        | 218 |
| 7.1.10.4 Interrupt assignments in APIC mode.....       | 219 |
| 7.2 Upgrade information.....                           | 220 |
| 7.2.1 BIOS upgrade.....                                | 220 |
| 7.2.1.1 Basic information.....                         | 220 |
| 7.2.1.2 Procedure in the EFI shell.....                | 221 |
| 7.2.2 Upgrading the firmware on the Panel PC 2100..... | 222 |
| 7.2.2.1 Procedure in Windows (ADI Control Center)..... | 222 |
| 7.2.2.2 Procedure in the EFI shell.....                | 222 |
| 7.2.2.3 Firmware upgrade with Automation Runtime.....  | 222 |
| 7.3 Multi-touch drivers.....                           | 223 |
| 7.4 Windows 10 IoT Enterprise 2016 LTSC.....           | 224 |
| 7.4.1 General information.....                         | 224 |
| 7.4.2 PPC2100 - Order data.....                        | 224 |
| 7.4.3 PPC2100 - Overview.....                          | 224 |
| 7.4.4 Features.....                                    | 224 |
| 7.4.5 Installation.....                                | 225 |
| 7.4.6 Drivers.....                                     | 225 |
| 7.4.7 Activation.....                                  | 225 |
| 7.4.8 Characteristics, limitations.....                | 225 |
| 7.4.9 Supported display resolutions.....               | 226 |
| 7.5 Windows 10 IoT Enterprise 2015 LTSC.....           | 227 |
| 7.5.1 General information.....                         | 227 |
| 7.5.2 PPC2100 - Order data.....                        | 227 |
| 7.5.3 Overview.....                                    | 227 |
| 7.5.4 Features.....                                    | 227 |
| 7.5.5 Installation.....                                | 228 |
| 7.5.6 Drivers.....                                     | 228 |
| 7.5.7 Activation.....                                  | 228 |
| 7.5.8 Content of delivery of the recovery DVD.....     | 229 |
| 7.5.9 Characteristics, limitations.....                | 229 |
| 7.5.10 Supported display resolutions.....              | 229 |
| 7.6 Windows Embedded 8.1 Industry Pro.....             | 230 |
| 7.6.1 General information.....                         | 230 |
| 7.6.2 Order data.....                                  | 230 |
| 7.6.3 Overview.....                                    | 230 |
| 7.6.4 Features.....                                    | 230 |
| 7.6.5 Installation.....                                | 231 |
| 7.6.6 Drivers.....                                     | 231 |
| 7.6.7 Activation.....                                  | 231 |
| 7.6.8 Content of delivery of the recovery DVD.....     | 232 |
| 7.6.9 Lockdown features.....                           | 232 |
| 7.6.10 Supported display resolutions.....              | 232 |
| 7.7 Windows 7.....                                     | 233 |
| 7.7.1 General information.....                         | 233 |
| 7.7.2 Order data.....                                  | 233 |
| 7.7.3 Overview.....                                    | 233 |
| 7.7.4 Installation.....                                | 233 |
| 7.7.5 Drivers.....                                     | 234 |
| 7.7.6 Characteristics, limitations.....                | 234 |

|   |            |
|---|------------|
| 7.7.7 Supported display resolutions.....                          | 234        |
| 7.8 Windows Embedded Standard 7.....                              | 235        |
| 7.8.1 General information.....                                    | 235        |
| 7.8.2 Order data.....   | 235        |
| 7.8.3 Overview.....   | 235        |
| 7.8.4 Features.....   | 235        |
| 7.8.5 Installation.....   | 236        |
| 7.8.6 Drivers.....  | 236        |
| 7.8.7 Characteristics, limitations.....                           | 236        |
| 7.8.8 Supported display resolutions.....                          | 236        |
| 7.9 Automation Runtime.....                                       | 237        |
| 7.9.1 General information.....                                    | 237        |
| 7.9.2 Order data.....   | 237        |
| 7.9.3 Automation Runtime Windows (ARwin).....                     | 237        |
| 7.9.4 Automation Runtime Embedded (ARemb).....                    | 238        |
| 7.9.5 Technology Guarding.....                                    | 238        |
| 7.10 B&R Hypervisor.....  | 239        |
| 7.11 mapp Technology.....   | 240        |
| 7.12 Linux for B&R 8 (GNU/Linux).....                             | 241        |
| 7.12.1 General information.....                                   | 241        |
| 7.12.2 Order data.....  | 241        |
| 7.12.3 Overview.....  | 241        |
| 7.12.4 Features.....  | 241        |
| 7.12.5 Installation.....  | 242        |
| 7.12.6 Drivers.....   | 242        |
| 7.13 Linux for B&R 9 (GNU/Linux).....                             | 243        |
| 7.13.1 General information.....                                   | 243        |
| 7.13.2 Order data.....  | 243        |
| 7.13.3 Overview.....  | 243        |
| 7.13.4 Features.....  | 243        |
| 7.13.5 Installation.....  | 243        |
| 7.13.6 Drivers.....   | 244        |
| 7.14 ADI Control Center.....                                      | 245        |
| 7.14.1 Functions.....   | 245        |
| 7.14.2 Installation.....  | 245        |
| 7.15 ADI Development Kit.....                                     | 246        |
| 7.16 ADI .NET SDK.....  | 247        |
| 7.17 Key Editor.....  | 248        |
| 7.18 KCF Editor.....  | 249        |
| 7.19 HMI Service Center.....                                      | 250        |
| 7.19.1 5SWUTI.0001-000.....                                       | 250        |
| 7.19.1.1 General information.....                                 | 250        |
| 7.19.1.2 Order data.....  | 250        |
| <b>8 Maintenance.....</b>   | <b>251</b> |
| 8.1 Cleaning.....   | 251        |
| 8.2 User tips for increasing the service life of the display..... | 251        |
| 8.2.1 Backlight.....  | 251        |
| 8.2.1.1 Measures to maintain backlight service life.....          | 251        |
| 8.2.2 Image persistence.....                                      | 251        |
| 8.2.2.1 What causes image persistence?.....                       | 251        |
| 8.2.2.2 How can image persistence be reduced?.....                | 252        |
| 8.3 Information about display properties.....                     | 252        |
| 8.4 Replacing CFast cards.....                                    | 253        |
| 8.5 Repairs/Complaints and replacement parts.....                 | 253        |

|  |            |
|--|------------|
| <b>9 International and national certifications.....</b>                  | <b>254</b> |
| 9.1 Directives and declarations.....                                     | 254        |
| 9.1.1 CE marking.....  | 254        |
| 9.1.2 EMC Directive.....   | 254        |
| 9.2 Certifications.....  | 255        |
| 9.2.1 UL certification.....  | 255        |
| 9.2.2 KC.....  | 255        |
| 9.2.3 UKCA.....  | 255        |
| 9.2.4 RCM.....   | 256        |
| 9.2.5 DNV certification.....   | 256        |
| 9.2.6 American Bureau of Shipping (ABS).....                             | 256        |
| 9.2.7 Bureau Veritas (BV).....   | 256        |
| 9.2.8 Lloyd's Register (LR).....   | 256        |
| 9.2.9 Korean Register of Shipping (KR).....                              | 256        |
| 9.2.10 Certifications for use in potentially explosive environments..... | 257        |
| 9.2.10.1 UL Haz. Loc. certification.....                                 | 257        |
| <b>10 Accessories.....</b>   | <b>265</b> |
| 10.1 General accessories.....  | 265        |
| 10.1.1 Accessories - Order data.....                                     | 265        |
| 10.2 Installation accessories.....                                       | 266        |
| 10.2.1 Order data.....   | 266        |
| 10.3 Terminal block power supply.....                                    | 267        |
| 10.3.1 0TB103.9x.....  | 267        |
| 10.3.1.1 General information.....  | 267        |
| 10.3.1.2 Order data.....   | 267        |
| 10.3.1.3 Technical data.....   | 267        |
| 10.4 Terminal block for IF options.....                                  | 268        |
| 10.4.1 0TB1210.3100.....   | 268        |
| 10.4.1.1 General information.....  | 268        |
| 10.4.1.2 Order data.....   | 268        |
| 10.4.1.3 Technical data.....   | 268        |
| 10.5 USB mass storage device.....  | 269        |
| 10.6 USB hub.....  | 270        |
| 10.6.1 5ACCUSB4.0000-000.....  | 270        |
| 10.6.1.1 General information.....  | 270        |
| 10.6.1.2 Order data.....   | 270        |
| 10.6.1.3 Technical data.....   | 270        |
| 10.6.1.4 Dimensions.....   | 272        |
| 10.7 Cables.....   | 272        |
| 10.8 Replacement parts.....  | 273        |
| 10.8.1 Replacement parts - Order data.....                               | 273        |
| <b>11 Environmentally friendly disposal.....</b>                         | <b>274</b> |
| 11.1 Separation of materials.....  | 274        |
| A.A Abbreviations.....   | 275        |
| A.B Maintenance Controller Extended (MTCX).....                          | 276        |
| A.C Viewing angles.....  | 277        |
| A.D Chemical resistance.....   | 278        |
| A.D.1 Autotex panel overlay (polyester).....                             | 279        |
| A.D.2 Aluminum panel overlay.....  | 280        |
| A.D.3 Coated aluminum front.....   | 280        |
| A.D.4 Touch screen.....  | 281        |
| A.E Touch screen.....  | 282        |
| A.E.1 5-wire touch screen (single-touch).....                            | 282        |
| A.E.1.1 Technical data.....  | 282        |
| A.E.1.2 Temperature/Humidity diagram.....                                | 282        |

|  |     |
|--|-----|
| A.E.2 Touch screen (multi-touch generation 2)..... | 283 |
| A.E.2.1 General information.....                   | 283 |
| A.E.2.2 Technical data.....                        | 283 |
| A.E.2.3 Temperature/Humidity diagram.....          | 283 |
| A.E.3 Touch screen (multi-touch generation 3)..... | 284 |
| A.E.3.1 General information.....                   | 284 |
| A.E.3.2 Technical data.....                        | 284 |
| A.E.3.3 Temperature/Humidity diagram.....          | 284 |
| A.F Cable data.....                                | 285 |
| A.F.1 RS232 - Bus length and cable type.....       | 285 |
| A.F.2 RS422 - Bus length and cable type.....       | 285 |
| A.F.3 RS485 - Bus length and cable type.....       | 286 |
| A.F.4 CAN - Bus length and cable type.....         | 286 |
| A.G POWERLINK.....                                 | 287 |
| A.G.1 LED "S/E" (status/error LED).....            | 287 |
| A.G.1.1 Ethernet mode.....                         | 287 |
| A.G.1.2 POWERLINK V2 mode.....                     | 287 |
| A.G.1.3 System stop error codes.....               | 289 |
| A.G.1.4 POWERLINK V2.....                          | 289 |
| A.H Installation compatibility.....                | 290 |
| A.H.1 Compatibility overview.....                  | 290 |
| A.H.2 Compatibility details.....                   | 292 |
| A.H.2.1 Example.....                               | 292 |
| A.H.2.2 5.7" devices.....                          | 292 |
| A.H.2.3 10.4" devices.....                         | 294 |
| A.H.2.4 12.1" devices.....                         | 296 |
| A.H.2.5 15" devices.....                           | 297 |
| A.H.2.6 17" devices.....                           | 298 |
| A.H.2.7 19" devices.....                           | 298 |
| A.H.2.8 21.3" devices.....                         | 299 |

# 1 Introduction

---

## **Information:**

B&R makes every effort to keep documents as current as possible. The most current versions are available for download on the B&R website ([www.br-automation.com](http://www.br-automation.com)).

## 1.1 Manual history

| Version | Date         | Changes <sup>1)</sup>  |
|---------|--------------|--|
| 2.02    | July 2024    | Updated the following sections: <ul style="list-style-type: none"> <li>• "Device interfaces - Overview" on page 47</li> <li>• "Ethernet interfaces" on page 49</li> <li>• "System units" on page 59</li> <li>• "Touch screen calibration" on page 187</li> </ul>   |
| 2.01    | June 2024    | <ul style="list-style-type: none"> <li>• Name change from "B&amp;R Linux" to "Linux for B&amp;R".</li> <li>• Updated the following sections:               <ul style="list-style-type: none"> <li>◦ "USB interfaces" on page 50</li> <li>◦ "Known problems / Characteristics" on page 189</li> <li>◦ "BIOS options" on page 190</li> <li>◦ "Operating systems" on page 224</li> <li>◦ "International and national certifications" on page 254</li> </ul> </li> <li>• Updated the following sections:               <ul style="list-style-type: none"> <li>◦ "Order number key" on page 22</li> <li>◦ "5ACCIF01.IS00-000" on page 166</li> <li>◦ "Firmware upgrade with Automation Runtime" on page 222</li> </ul> </li> </ul>  |
| 2.00    | January 2022 | <ul style="list-style-type: none"> <li>• Updated the following panels:               <ul style="list-style-type: none"> <li>◦ "5AP1130.101D-000" on page 88</li> <li>◦ "5AP1130.121E-010" on page 111</li> <li>◦ "5AP1130.156C-001" on page 125</li> </ul> </li> <li>• Updated the following sections:               <ul style="list-style-type: none"> <li>◦ "General safety guidelines" on page 14</li> <li>◦ "Software" on page 190</li> <li>◦ "USB hub" on page 270 and "Installing the USB hub" on page 179</li> <li>◦ "Accessories" on page 265</li> </ul> </li> <li>• EN 60950 replaced by IEC 61010-2-201.</li> <li>• "CFast cards", "Cables" and "USB mass storage device" are described in their own documentation starting with this version.</li> <li>• Updated the CAN interface description, see sections "Interface options" on page 132 and "Appendix A" on page 275.</li> </ul>   |
| 1.17    | 2018-06-22   | Updated section "Network stack" on page 207.   |
| 1.16    | 2018-06-20   | <ul style="list-style-type: none"> <li>• Documented interface option "5ACCIF01.FSS0-000" on page 159.</li> <li>• Updated entire chapter "Technical data".</li> <li>• Updated the following sections:               <ul style="list-style-type: none"> <li>◦ "Configuration" on page 20</li> <li>◦ Important information for installation/commissioning</li> <li>◦ "Installing the Automation Panel 1000 with clamping blocks" on page 175</li> <li>◦ "Grounding concept - Functional ground" on page 180</li> <li>◦ "Known problems / Characteristics" on page 189</li> <li>◦ "BIOS options" on page 190</li> <li>◦ "Multi-touch drivers" on page 223</li> <li>◦ "Linux for B&amp;R 8 (GNU/Linux)" on page 241</li> <li>◦ "UL certification" on page 255</li> <li>◦ "DNV certification" on page 256</li> <li>◦ "Maintenance" on page 251</li> <li>◦ "Repairs/Complaints and replacement parts" on page 253</li> <li>◦ "Chemical resistance" on page 278</li> </ul> </li> <li>• Updated the following sections:               <ul style="list-style-type: none"> <li>◦ "Linux for B&amp;R 9 (GNU/Linux)" on page 243</li> <li>◦ "Windows 10 IoT Enterprise 2016 LTSB" on page 224</li> <li>◦ "B&amp;R Hypervisor" on page 239</li> <li>◦ "mapp Technology" on page 240</li> </ul> </li> </ul> |
| 1.15    | 2017-04-25   | <ul style="list-style-type: none"> <li>• Renamed "display units" to "panels".</li> <li>• Updated 4-port USB hub "5ACCUSB4.0000-000" on page 270.</li> <li>• Updated installation of 4-port USB hub, see "Installing the USB hub" on page 179.</li> <li>• Updated section "Multi-touch drivers" on page 223.</li> <li>• Updated section "+24 VDC power supply" on page 48.</li> <li>• Updating chapter 9 "International and national certifications".</li> <li>• Documented configuration option for XHCI controller, see "USB configuration" on page 209.</li> <li>• Updated the following panels:               <ul style="list-style-type: none"> <li>◦ "5AP1130.0702-000" on page 86</li> <li>◦ "5AP1130.101E-000" on page 92</li> </ul> </li> </ul>  |

## Introduction

| Version | Date | Changes <sup>1)</sup>   |
|---------|------|---|
|         |      | <ul style="list-style-type: none"><li>◦ "5AP1130.121E-000" on page 109</li><li>◦ "5AP1130.156C-000" on page 123</li><li>◦ "5AP1130.185C-000" on page 127</li><li>• Documented system unit 5PPC2100.BY48-000 on page 59.</li><li>• Documented interface option "5ACCIF01.FPCS-000" on page 137.</li><li>• Updated data in sections "Mechanical properties", "Environmental properties" and "Electrical properties".</li><li>• Updated section "Touch screen" with "Touch screen (multi-touch generation 2)" and "Touch screen (multi-touch generation 3)".</li><li>• Updated CFast card 5CFAST.256G-10, see "CFast cards" on page 168.</li></ul> |

1) Editorial changes are not listed.

## 1.2 Information about this document

**This document is not intended for end customers! The safety guidelines required for end customers must be incorporated into the operating instructions for end customers in the respective national language by the machine manufacturer or system provider.**

### 1.2.1 Organization of notices

#### Safety notices

Contain **only** information that warns of dangerous functions or situations.

| Signal word     | Description   |
|-----------------|---|
| <b>Danger!</b>  | Failure to observe these safety guidelines and notices will result in death, severe injury or substantial damage to property. |
| <b>Warning!</b> | Failure to observe these safety guidelines and notices can result in death, severe injury or substantial damage to property.  |
| <b>Caution!</b> | Failure to observe these safety guidelines and notices can result in minor injury or damage to property.                      |
| <b>Notice!</b>  | Failure to observe these safety guidelines and notices can result in damage to property.                                      |

#### General notices

Contain **useful** information for users and instructions for avoiding malfunctions.

| Signal word         | Description  |
|---------------------|--|
| <b>Information:</b> | Useful information, application tips and instructions for avoiding malfunctions. |

### 1.2.2 Guidelines

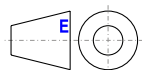

European dimension standards apply to all dimension diagrams.

**All dimensions, specifications in dimension diagrams and associated tables are in millimeters [mm].**

Unless otherwise specified, the following general tolerances apply:

| Nominal dimension range | General tolerance per DIN ISO 2768 medium |
|-------------------------|---|
| Up to 6 mm              | ±0.1 mm                                   |
| Over 6 to 30 mm         | ±0.2 mm                                   |
| Over 30 to 120 mm       | ±0.3 mm                                   |
| Over 120 to 400 mm      | ±0.5 mm                                   |
| Over 400 to 1000 mm     | ±0.8 mm                                   |

## 2 General safety guidelines

---

### 2.1 Intended use

In all cases, applicable national and international standards, regulations and safety measures must be taken into account and observed!

The B&R products described in this manual are intended for use in industry and industrial applications. The intended use includes control, operation, monitoring, drive and HMI tasks as part of automation processes in machines and systems.

B&R products are only permitted to be used in their original condition. Modifications and extensions are only permitted if they are described in this manual.

B&R excludes liability for damage of any kind resulting from the use of B&R products in any intended way.

B&R products have not been designed, developed and manufactured for use that involves fatal risks or hazards that could result in death, injury, serious physical harm or other loss without the assurance of exceptionally stringent safety precautions.

B&R products are explicitly not intended for use in the following applications:

- Monitoring and control of thermonuclear processes
- Weapon systems control
- Flight and traffic control systems for passenger and freight transport
- Health monitoring and life support systems

### 2.2 Protection against electrostatic discharge

Electrical assemblies that can be damaged by electrostatic discharge (ESD) must be handled accordingly.

#### 2.2.1 Packaging

- **Electrical assemblies with housing:**  
Do not require special ESD packaging but must be handled properly (see "Electrical assemblies with housing").
- **Electrical assemblies without housing:**  
Are protected by ESD-suitable packaging.

#### 2.2.2 Regulations for proper ESD handling

##### Electrical assemblies with housing

- Do not touch the connector contacts of connected cables.
- Do not touch the contact tips on circuit boards.

## Electrical assemblies without housing

The following applies in addition to "Electrical assemblies with housing":

- All persons handling electrical assemblies and devices in which electrical assemblies are installed must be grounded.
- Assemblies are only permitted to be touched on the narrow sides or front plate.
- Always place assemblies on suitable surfaces (ESD packaging, conductive foam, etc.). Metallic surfaces are not suitable surfaces!
- Assemblies must not be subjected to electrostatic discharges (e.g. due to charged plastics).
- A minimum distance of 10 cm from monitors or television sets must be maintained.
- Measuring instruments and devices must be grounded.
- Test probes of floating potential measuring instruments must be discharged briefly on suitable grounded surfaces before measurement.

## Individual components

- ESD protective measures for individual components are implemented throughout B&R (conductive floors, shoes, wrist straps, etc.).
- The increased ESD protective measures for individual components are not required for handling B&R products at customer locations.

## 2.3 Regulations and measures

Electronic devices are generally not failsafe. If the programmable logic controller, operating or control device or uninterruptible power supply fails, the user is responsible for ensuring that connected devices (such as motors) are brought to a safe state.

When using programmable logic controllers as well as when using operating and monitoring devices as control systems in conjunction with a Soft PLC (e.g. B&R Automation Runtime or similar product) or Slot PLC (e.g. B&R LS251 or similar product), the safety measures that apply to industrial controllers (protection by protective equipment such as emergency stops) must be observed in accordance with applicable national and international regulations. This also applies to all other connected devices, such as drives.

All work such as installation, commissioning and servicing are only permitted to be carried out by qualified personnel. Qualified personnel are persons who are familiar with the transport, installation, assembly, commissioning and operation of the product and have the appropriate qualifications for their job (e.g. IEC 60364). National accident prevention regulations must be observed.

The safety guidelines, information about connection conditions (nameplate and documentation) and limit values specified in the technical data must be read carefully before installation and commissioning and must be strictly observed.

## 2.4 Transport and storage

During transport and storage, devices must be protected against undue stress (mechanical stress, temperature, humidity, aggressive atmosphere).

## 2.5 Installation

- The devices are not ready for use and must be installed and wired according to the requirements of this documentation in order to comply with EMC limit values.
- Installation must be carried out according to the documentation using suitable equipment and tools.
- Devices are only permitted to be installed in a voltage-free state and by qualified personnel. The control cabinet must first be disconnected from the power supply and secured against being switched on again.
- General safety regulations and national accident prevention regulations must be observed.
- The electrical installation must be carried out in accordance with relevant regulations (e.g. line cross section, fuse protection, protective ground connection).

## 2.6 Operation

### 2.6.1 Protection against contact with electrical parts

In order to operate programmable logic controllers, operating and monitoring devices and uninterruptible power supplies, it is necessary for certain components to carry dangerous voltages over 42 VDC. Touching one of these components can result in a life-threatening electric shock. There is a risk of death, serious injury or damage to property.

Before switching on programmable logic controllers, operating and monitoring devices and uninterruptible power supplies, it must be ensured that the housing is properly connected to ground potential (PE rail). Ground connections must also be made if the operating and monitoring device and uninterruptible power supply are only connected for testing purposes or only operated for a short time!

Before switching on, live parts must be securely covered. All covers must be kept closed during operation.

### 2.6.2 Ambient conditions - Dust, moisture, aggressive gases

The use of operating and monitoring devices (e.g. industrial PCs, Power Panels, Mobile Panels) and uninterruptible power supplies in dusty environments must be avoided. This can otherwise result in dust deposits that affect the functionality of the device, especially in systems with active cooling (fans), which may no longer ensure sufficient cooling.

The presence of aggressive gases in the environment can also result in malfunctions. In combination with high temperature and relative humidity, aggressive gases – for example with sulfur, nitrogen and chlorine components – trigger chemical processes that can very quickly impair or damage electronic components. Blackened copper surfaces and cable ends in existing installations are indicators of aggressive gases.

When operated in rooms with dust and condensation that can endanger functionality, operating and monitoring devices such as Automation Panels or Power Panels are protected on the front against the ingress of dust and moisture when installed correctly (e.g. cutout installation). The back of all devices must be protected against the ingress of dust and moisture, however, or the dust deposits must be removed at suitable intervals.

### 2.6.3 Programs, viruses and malicious programs

Any data exchange or installation of software using data storage media (e.g. floppy disk, CD-ROM, USB flash drive) or via networks or the Internet poses a potential threat to the system. It is the direct responsibility of the user to avert these dangers and to take appropriate measures such as virus protection programs and firewalls to protect against them and to use only software from trustworthy sources.

## 2.7 Cybersecurity disclaimer for products

B&R products communicate via a network interface and were developed for secure connection with internal and, if necessary, other networks such as the Internet.

### Information:

**In the following, B&R products are referred to as "product" and all types of networks (e.g. internal networks and the Internet) are referred to as "network".**

It is the sole responsibility of the customer to establish and continuously ensure a secure connection between the product and the network. In addition, appropriate security measures must be implemented and maintained to protect the product and entire network from any security breaches, unauthorized access, interference, digital intrusion, data leakage and/or theft of data or information.

B&R Industrial Automation GmbH and its subsidiaries are not liable for damages and/or losses in connection with security breaches, unauthorized access, interference, digital intrusion, data leakage and/or theft of data or information.

The aforementioned appropriate security measures include, for example:

- Segmentation of the network (e.g. separation of the IT network from the control network<sup>1)</sup>)
- Use of firewalls
- Use of authentication mechanisms
- Encryption of data
- Use of anti-malware software

Before B&R releases products or updates, they are subjected to appropriate functional testing. Independently of this, we recommend that our customers develop their own test processes in order to be able to check the effects of changes in advance. Such changes include, for example:

- Installation of product updates
- Significant system modifications such as configuration changes
- Deployment of updates or patches for third-party software (non-B&R software)
- Hardware replacement

These tests should ensure that implemented security measures remain effective and that systems in the customer's environment behave as expected.

<sup>1)</sup> The term "control network" refers to computer networks used to connect control systems. The control network can be divided into zones, and there can be several separate control networks within a company or site. The term "control systems" refers to all types of B&R products such as controllers (e.g. X20), HMI systems (e.g. Power Panel T30), process control systems (e.g. APROL) and supporting systems such as engineering workstations with Automation Studio.

## 3 System overview

---

### 3.1 About this user's manual

This user's manual contains all relevant information about an operational Panel PC 2100 cabinet-mounted device.

**Information:**

All specifications in dimension diagrams and associated tables are in millimeters [mm].

## 3.2 Description of individual modules

### 3.2.1 System units

System units consist of a CPU board and aluminum housing. They include all of the interfaces and main memory on PPC2100 devices in addition to interface option and CFast card connections. Main memory is permanently built into the system unit and cannot be replaced.

If a system unit is installed on a panel, the result is an operational Panel PC 2100. Panel PC 2100 systems are mounted using retaining clips.

A system unit cannot function without a panel.



### 3.2.2 AP9x3 panels

AP9x3 panels form the basis for the Automation Panel 9x3, Panel PC 900, Panel PC 2100, Panel PC 2200 and Panel PC 3100 system families. They consist of a display and touch screen. Different display diagonals and touch screen technologies are available. The panels are installed using retaining clips.

Single-touch panels start with order number 5AP923.xxxx-xx; multi-touch panels start with order number 5AP933.xxxx-xx.

The panels can only be operated as a complete system in combination with a link module or Panel PC.



### 3.2.3 AP1000 panels

AP1000 panels form the basis for the Automation Panel 1000, Panel PC 900, Panel PC 2100, Panel PC 2200 and Panel PC 3100 system families. Different display diagonals and touch screen technologies as well as panels with touch screen and keys are available.

Panels are installed using retaining clips or clamping blocks.

The panels can only be operated as a complete system in combination with a link module or Panel PC.







## 3.3 Design/Configuration





Automation Panel 9x3, Panel PC 900, Panel PC 2100, Panel PC 2200 and Panel PC 3100 systems can be assembled to meet individual requirements and operating conditions. Automation Panel 9x3, Panel PC 900, Panel PC 2100, Panel PC 2200 and Panel PC 3100 systems are flexible so that an Automation Panel can be converted to a Panel PC or vice versa.

### 3.3.1 Configuration

The following individual components are required for operation as a Panel PC 2100:

- Panel
- System unit
- CFAST card for the operating system
- Operating system

| Base system - Configuration   |                          |                  |                             |                     |                  |                     |
|---|--------------------------|------------------|-----------------------------|---------------------|------------------|---------------------|
| <b>Panels</b>   |                          |                  |                             |                     |                  | Select 1.           |
|   | <b>923 panels</b>        | <b>Diagonal</b>  | <b>Resolution</b>           | <b>Touch screen</b> | <b>Keys</b>      | <b>Format</b>       |
|   | 5AP923.1215-00           | 12.1"            | XGA                         | Single-touch        | No               | Landscape           |
|   | 5AP923.1505-00           | 15.0"            | XGA                         | Single-touch        | No               | Landscape           |
|   | 5AP923.1906-00           | 19.0"            | SXGA                        | Single-touch        | No               | Landscape           |
|   | <b>933 panels</b>        |                  |                             |                     |                  |                     |
|   | 5AP933.156B-00           | 15.6"            | HD                          | Multi-touch         | No               | Landscape           |
|   | 5AP933.185B-00           | 18.5"            | HD                          | Multi-touch         | No               | Landscape           |
|   | 5AP933.215C-00           | 21.5"            | FHD                         | Multi-touch         | No               | Landscape           |
|   | 5AP933.240C-00           | 24.0"            | FHD                         | Multi-touch         | No               | Landscape           |
|   | <b>1120 panels</b>       |                  |                             |                     |                  |                     |
|   | 5AP1120.0573-000         | 5.7"             | VGA                         | Single-touch        | No               | Landscape           |
|   | 5AP1120.0702-000         | 7.0"             | WVGA                        | Single-touch        | No               | Landscape           |
|   | 5AP1120.101E-000         | 10.1"            | WXGA                        | Single-touch        | No               | Landscape           |
|   | 5AP1120.1043-000         | 10.4"            | VGA                         | Single-touch        | No               | Landscape           |
|   | 5AP1120.1214-000         | 12.1"            | SVGA                        | Single-touch        | No               | Landscape           |
|   | 5AP1120.121E-000         | 12.1"            | WXGA                        | Single-touch        | No               | Landscape           |
|   | 5AP1120.1505-000         | 15.0"            | XGA                         | Single-touch        | No               | Landscape           |
|   | 5AP1120.156B-000         | 15.6"            | HD                          | Single-touch        | No               | Landscape           |
|   | 5AP1120.1906-000         | 19.0"            | SXGA                        | Single-touch        | No               | Landscape           |
|   | <b>1130 panels</b>       |                  |                             |                     |                  |                     |
|   | 5AP1130.0702-000         | 7.0"             | WVGA                        | Multi-touch         | No               | Landscape           |
|   | 5AP1130.101D-000         | 10.1"            | WUXGA                       | Multi-touch         | No               | Landscape           |
|   | 5AP1130.101E-000         | 10.1"            | WXGA                        | Multi-touch         | No               | Landscape           |
|   | 5AP1130.121E-000         | 12.1"            | WXGA                        | Multi-touch         | No               | Landscape           |
|   | 5AP1130.121E-010         | 12.1"            | WXGA                        | Multi-touch         | No               | Landscape           |
|   | 5AP1130.156C-000         | 15.6"            | FHD                         | Multi-touch         | No               | Landscape           |
|   | 5AP1130.156C-001         | 15.6"            | FHD                         | Multi-touch         | No               | Landscape           |
|   | 5AP1130.185C-000         | 18.5"            | FHD                         | Multi-touch         | No               | Landscape           |
|   | <b>1151 panels</b>       |                  |                             |                     |                  |                     |
|   | 5AP1151.0573-000         | 5.7"             | VGA                         | No                  | Yes              | Portrait            |
|   | <b>1180 panels</b>       |                  |                             |                     |                  |                     |
|   | 5AP1180.1043-000         | 10.4"            | VGA                         | Single-touch        | Yes              | Landscape           |
|   | 5AP1180.1505-000         | 15.0"            | XGA                         | Single-touch        | Yes              | Landscape           |
| <b>1181 panels</b>  |                          |                  |                             |                     |                  |                     |
| 5AP1181.1043-000  | 10.4"                    | VGA              | Single-touch                | Yes                 | Portrait         |                     |
| 5AP1181.1505-000  | 15.0"                    | XGA              | Single-touch                | Yes                 | Landscape        |                     |
| <b>1182 panels</b>  |                          |                  |                             |                     |                  |                     |
| 5AP1182.1043-000  | 10.4"                    | VGA              | Single-touch                | Yes                 | Landscape        |                     |
| <b>System units</b>   |                          |                  |                             |                     |                  | Select 1.           |
|  | System unit              | Processor        | Processor - Clock frequency | Cores               | Main memory type | Main memory size    |
|   | 5PPC2100.BY01-000        | Intel Atom E3815 | 1460 MHz                    | 1                   | DDR3 SDRAM       | 1 GB                |
|   | 5PPC2100.BY11-000        | Intel Atom E3825 | 1330 MHz                    | 2                   | DDR3 SDRAM       | 1 GB                |
|   | 5PPC2100.BY22-000        | Intel Atom E3826 | 1460 MHz                    | 2                   | DDR3 SDRAM       | 2 GB                |
|   | 5PPC2100.BY34-000        | Intel Atom E3827 | 1750 MHz                    | 2                   | DDR3 SDRAM       | 4 GB                |
|   | 5PPC2100.BY44-000        | Intel Atom E3845 | 1910 MHz                    | 4                   | DDR3 SDRAM       | 4 GB                |
|   | 5PPC2100.BY48-000        | Intel Atom E3845 | 1910 MHz                    | 4                   | DDR3 SDRAM       | 8 GB                |
| <b>Mass storage devices</b>   |                          |                  |                             |                     |                  | Select 1.           |
|  | <b>CFAST cards</b>       |                  |                             |                     |                  |                     |
|   | 5CFAST.2048-00 ≥ E0      |                  | 5CFAST.032G-10              |                     |                  |                     |
|   | 5CFAST.4096-00 ≥ E0      |                  | 5CFAST.064G-10              |                     |                  |                     |
|   | 5CFAST.8192-00 ≥ E0      |                  | 5CFAST.128G-10              |                     |                  |                     |
|   | 5CFAST.016G-00 ≥ E0      |                  | 5CFAST.256G-10              |                     |                  |                     |
|   | 5CFAST.032G-00 ≥ E0      |                  |                             |                     |                  |                     |
| <b>Accessories and software - Configuration</b>                                     |                          |                  |                             |                     |                  |                     |
| <b>Interfaces</b>   |                          |                  |                             |                     |                  | Optional, select 1. |
|  | <b>Interface options</b> |                  |                             |                     |                  |                     |
|   | 5ACCIF01.FPCC-000        |                  | 5ACCIF01.FPLK-000           |                     |                  |                     |
|   | 5ACCIF01.FPLS-000        |                  | 5ACCIF01.FPLS-001           |                     |                  |                     |
|   | 5ACCIF01.FPSC-000        |                  | 5ACCIF01.FPSC-001           |                     |                  |                     |
|   | 5ACCIF01.FPCS-000        |                  | 5ACCIF01.FSS0-000           |                     |                  |                     |
|   | 5ACCIF01.ICAN-000        |                  | 5ACCIF01.IS00-000           |                     |                  |                     |

| USB accessories   |  | Optional selection  |  |
|---|--|---|--|
|  |  | 5MMUSB.2048-01<br>5MMUSB.4096-01<br>5MMUSB.032G-02  |  |
| USB hub   |  | Optional selection  |  |
|  |  | 5ACCUSB4.0000-000   |  |
| Terminal blocks   |  | Select 1.   |  |
|  | <b>Power supply connectors</b><br>0TB103.9<br>0TB103.91  | <b>Terminal block for IF option</b><br>0TB1210.3100   |  |
| Operating systems   |  | Select 1.   |  |
|  | <b>Windows 7</b><br>5SWWI7.1100-ENG<br>5SWWI7.1100-GER<br>5SWWI7.1300-MUL<br>5SWWI7.1200-ENG<br>5SWWI7.1200-GER<br>5SWWI7.1400-MUL<br><br><b>Windows Embedded Standard 7</b><br>5SWWI7.1543-ENG<br>5SWWI7.1643-ENG<br>5SWWI7.1743-MUL<br>5SWWI7.1843-MUL | <b>Windows Embedded 8.1 Industry</b><br>5SWWI8.0343-MUL<br>5SWWI8.0443-MUL<br><br><b>Windows 10</b><br>5SWW10.0243-MUL<br>5SWW10.0543-MUL<br><br><b>Linux for B&amp;R 8</b><br>5SWLIN.0543-MUL<br>5SWLIN.0643-MUL | <b>Automation Runtime</b><br>0TG1000.01<br>0TG1000.02<br>1TG4600.10-5<br>1TG4601.06-5<br>1TG4601.06-T<br><br><b>Linux for B&amp;R 9</b><br>5SWLIN.0743-MUL |

### 3.3.2 Order number key

#### **Information:**

A current order number key is available on the B&R website for easy identification of the device configuration:

[Home > Downloads > Industrial PCs and Panels > Panel PC 2100](#)

### 3.4 Overview

| Order number               | Short description   | Page |
|----------------------------|---|------|
| <b>Accessories</b>         |   |      |
| 0TB103.9                   | Connector 24 VDC - 3-pin, female - Screw clamp terminal block 3.31 mm <sup>2</sup>  | 267  |
| 0TB103.91                  | Connector 24 VDC - 3-pin, female - Cage clamp terminal block 3.31 mm <sup>2</sup>   | 267  |
| 5ACCSB4.0000-000           | USB hub 4x passive - For APC2100/PPC2100  | 270  |
| 5SWUT1.0001-000            | HMI Service Center USB flash drive - Hardware diagnostic software - For APC910/PPC900 - For PPC1200 - For APC2100/PPC2100 - For APC2200/PPC2200 - For APC3100/PPC3100 - For APC mobile - For AP800/AP900 - For AP9x3/AP9xD - For AP1000/AP5000  | 250  |
| <b>Interface options</b>   |   |      |
| 5ACCIF01.FPCC-000          | Interface card - 2x CAN interfaces - 1x X2X Link interface - 1x POWERLINK interface - 512 kB nvSRAM - For APC2100/PPC2100/APC2200/PPC2200 - Only available with a new device  | 132  |
| 5ACCIF01.FPCS-000          | Interface card - 1x RS485 interface - 1x CAN interface - 1x POWERLINK interface - 32 kB FRAM - For APC2100/PPC2100/APC2200/PPC2200 - Only available with a new device   | 137  |
| 5ACCIF01.FPLK-000          | Interface card - 1x POWERLINK interface - Integrated 2-port hub - 512 kB nvSRAM - For APC2100/PPC2100/APC2200/PPC2200 - Only available with a new device  | 141  |
| 5ACCIF01.FPLS-000          | Interface card - 1x RS232 interface - 1x POWERLINK interface - 32 kB FRAM - For APC2100/PPC2100/APC2200/PPC2200 - Only available with a new device  | 144  |
| 5ACCIF01.FPLS-001          | Interface card - 1x RS232 interface - 1x POWERLINK interface - 512 kB nvSRAM - For APC2100/PPC2100/APC2200/PPC2200 - Only available with a new device   | 147  |
| 5ACCIF01.FPSC-000          | Interface card - 1x RS232 interface - 1x CAN interface - 1x POWERLINK interface - 32 kB FRAM - For APC2100/PPC2100/APC2200/PPC2200 - Only available with a new device   | 150  |
| 5ACCIF01.FPSC-001          | Interface card - 1x RS232 interface - 1x CAN interface - 1x X2X Link Interface - 1x POWERLINK interface - 512 kB nvSRAM - For APC2100/PPC2100/APC2200/PPC2200 - Only available with a new device  | 154  |
| 5ACCIF01.FSS0-000          | Interface card - 2x RS422/RS485 interface - For APC2100/PPC2100/APC2200/PPC2200 - Only available with a new device  | 159  |
| 5ACCIF01.ICAN-000          | Interface card - 1x CAN interface - For APC2100/PPC2100/APC2200/PPC2200 - Only available with a new device  | 163  |
| 5ACCIF01.IS00-000          | Interface card - 1x RS232 interface - For APC2100/PPC2100/APC2200/PPC2200 - Only available with a new device  | 166  |
| <b>Linux for B&amp;R 8</b> |   |      |
| 5SWLIN.0543-MUL            | Linux for B&R 8 - 32-bit - Multilingual - PPC2100 Bay Trail chipset - Installation - Only available with a new device   | 241  |
| 5SWLIN.0643-MUL            | Linux for B&R 8 - 64-bit - Multilingual - PPC2100 Bay Trail chipset - Installation - Only available with a new device   | 241  |
| <b>Linux for B&amp;R 9</b> |   |      |
| 5SWLIN.0743-MUL            | Linux for B&R 9 - 64-bit - Multilingual - PPC2100 Bay Trail chipset - Installation - Only available with a new device   | 243  |
| <b>Other</b>               |   |      |
| 5ACCRHMI.0006-000          | HMI installation tool for control cabinet - 1x torque wrench 0.4 - 2.0 Nm - 1x hex head bit 2.5, length 89 mm - 1x hex head bit 3.0, length 89 mm - 1x hex head bit 5.0, length 89 mm - 1x Torx 10 bit, length 90 mm - 1x Torx 20 bit, length 89 mm   | 266  |
| <b>Panels</b>              |   |      |
| 5AP1120.0573-000           | Automation Panel 5.7" VGA TFT - 640 x 480 pixels (4:3) - Single-touch (analog resistive) - Control cabinet installation - Landscape format - For PPC2100 / PPC2200 / link modules - Compatible with 5PP520.0573-00  | 78   |
| 5AP1120.0702-000           | Automation Panel 7" WVGA TFT - 800 x 480 pixels (16:10) - Single-touch (analog resistive) - Control cabinet installation - Landscape format - For PPC2100 / PPC2200 / link modules - Compatible with 5PP520.0702-00   | 84   |
| 5AP1120.101E-000           | Automation Panel 10.1" WXGA TFT - 1280 x 800 pixels (16:10) - Single-touch (analog resistive) - Control cabinet installation - Landscape format - For PPC2100 / PPC3100 / PPC2200 / link modules  | 90   |
| 5AP1120.1043-000           | Automation Panel 10.4" VGA TFT - 640 x 480 pixels (4:3) - Single-touch (analog resistive) - Control cabinet installation - Landscape format - Front USB - For PPC900/PPC2100/PPC3100/PPC2200 - For link modules - Compatible with 5PP520.1043-00  | 94   |
| 5AP1120.1214-000           | Automation Panel 12.1" SVGA TFT - 800 x 600 pixels (4:3) - Single-touch (analog resistive) - Control cabinet installation - Landscape format - Front USB - For PPC900/PPC2100/PPC3100/PPC2200 - For link modules - Compatible with 5PP520.1214-00   | 105  |
| 5AP1120.121E-000           | Automation Panel 12.1" WXGA TFT - 1280 x 800 pixels (16:10) - Single-touch (analog resistive) - Control cabinet installation - Landscape format - For PPC2100 / PPC3100 / PPC2200 / link modules  | 107  |
| 5AP1120.1505-000           | Automation Panel 15.0" XGA TFT - 1024 x 768 pixels (4:3) - Single-touch (analog resistive) - Control cabinet installation - Landscape format - Front USB - For PPC900/PPC2100/PPC3100/PPC2200 - For link modules - Compatible with 5PP520.1505-00, 5AP920.1505-01, 5PC720.1505-xx, 5PC820.1505-00 | 113  |
| 5AP1120.156B-000           | Automation Panel 15.6" HD TFT - 1366 x 768 pixels (16:9) - Single-touch (analog resistive) - Control cabinet installation - Landscape format - For PPC900/PPC2100/PPC3100/PPC2200 - For link modules  | 120  |
| 5AP1120.1906-000           | Automation Panel 19.0" SXGA TFT - 1280 x 1024 pixels (5:4) - Single-touch (analog resistive) - Control cabinet installation - Landscape format - Front USB - For PPC900/PPC2100/PPC3100/PPC2200 - For link modules - Compatible with 5AP920.1906-01, 5PC720.1906-00, 5PC820.1906-00               | 129  |
| 5AP1130.0702-000           | Automation Panel 7.0" WVGA TFT - 800 x 480 pixels (16:10) - Multi-touch (projected capacitive) - Control cabinet installation - Landscape format - For PPC2100 / PPC2200 / link modules - Compatible with 5PP520.0702-00  | 86   |
| 5AP1130.101D-000           | Automation Panel 10.1" High Resolution - 1920 x 1200 pixels (16:10) - Multi-touch (projected capacitive) - Control cabinet installation - Landscape format - For PPC2100/PPC3100/PPC2200 - For link modules   | 88   |
| 5AP1130.101E-000           | Automation Panel 10.1" WXGA TFT - 1280 x 800 pixels (16:10) - Multi-touch (projected capacitive) - Control cabinet installation - Landscape format - For PPC2100 / PPC3100 / PPC2200 / link modules   | 92   |
| 5AP1130.121E-000           | Automation Panel 12.1" WXGA TFT - 1280 x 800 pixels (16:10) - Multi-touch (projected capacitive) - Control cabinet installation - Landscape format - For PPC2100 / PPC3100 / PPC2200 / link modules   | 109  |
| 5AP1130.121E-010           | Automation Panel 12.1" sunlight readable - 1280 x 800 pixels (16:10) - Multi-touch (projected capacitive) - Control cabinet installation - Landscape format - For PPC2100/PPC3100/PPC2200 - For link modules  | 111  |
| 5AP1130.156C-000           | Automation Panel 15.6" Full HD TFT - 1920 x 1080 pixels (16:9) - Multi-touch (projected capacitive) - Control cabinet installation - Landscape format - For PPC900/PPC2100/PPC3100/PPC2200 - For link modules   | 123  |
| 5AP1130.156C-001           | Automation Panel 15.6" Full HD TFT - 1920 x 1080 pixels (16:9) - Multi-touch (projected capacitive) - Control cabinet installation - Landscape format - Optical bonding - For PPC900/PPC2100/PPC3100/PPC2200 - For link modules   | 125  |
| 5AP1130.185C-000           | Automation Panel 18.5" Full HD TFT - 1920 x 1080 pixels (16:9) - Multi-touch (projected capacitive) - Control cabinet installation - Landscape format - For PPC900/PPC2100/PPC3100/PPC2200 - For link modules   | 127  |

## System overview

| Order number                               | Short description  | Page |
|--|--|------|
| 5AP1151.0573-000                           | Automation Panel 5.7" VGA TFT - 640 x 480 pixels (4:3) - Control cabinet installation - Portrait format - 22 function keys and 20 system keys - For PPC2100 / PPC2200 / link modules - Compatible with 5PP551.0573-00  | 81   |
| 5AP1180.1043-000                           | Automation Panel 10.4" VGA TFT - 640 x 480 pixels (4:3) - Single-touch (analog resistive) - Control cabinet installation - Landscape format - Front USB - 22 function keys - For PPC900/PPC2100/PPC3100/PPC2200 - For link modules - Compatible with 5PP580.1043-00, 5AP980.1043-01                                    | 96   |
| 5AP1180.1505-000                           | Automation Panel 15.0" XGA TFT - 1024 x 768 pixels (4:3) - Single-touch (analog resistive) - Control cabinet installation - Landscape format - Front USB - 32 function keys - For PPC900/PPC2100/PPC3100/PPC2200 - For link modules - Compatible with 5PP580.1505-00, 5AP980.1505-01                                   | 115  |
| 5AP1181.1043-000                           | Automation Panel 10.4" VGA TFT - 640 x 480 pixels (4:3) - Single-touch (analog resistive) - Control cabinet installation - Portrait format - Front USB - 38 function keys and 20 system keys - For PPC900/PPC2100/PPC3100/PPC2200 - For link modules - Compatible with 5PP581.1043-00, 5AP981.1043-01, 5PC781.1043-00  | 99   |
| 5AP1181.1505-000                           | Automation Panel 15" XGA TFT - 1024 x 768 pixels (4:3) - Single-touch (analog resistive) - Control cabinet installation - Landscape format - Front USB - 32 function keys and 92 system keys - For PPC900/PPC2100/PPC3100/PPC2200 - For link modules - Compatible with 5PP581.1505-000                                 | 117  |
| 5AP1182.1043-000                           | Automation Panel 10.4" VGA TFT - 640 x 480 pixels (4:3) - Single-touch (analog resistive) - Control cabinet installation - Landscape format - Front USB - 44 function keys and 20 system keys - For PPC900/PPC2100/PPC3100/PPC2200 - For link modules - Compatible with 5PP582.1043-00, 5AP982.1043-01, 5PC782.1043-00 | 102  |
| 5AP923.1215-00                             | Automation Panel 12.1" XGA TFT - 1024 x 768 pixels (4:3) - Single-touch (analog resistive) - Control cabinet installation - Landscape format - For PPC900/PPC2100/PPC3100/PPC2200 - For link modules   | 62   |
| 5AP923.1505-00                             | Automation Panel 15.0" XGA TFT - 1024 x 768 pixels (4:3) - Single-touch (analog resistive) - Control cabinet installation - Landscape format - For PPC900/PPC2100/PPC3100/PPC2200 - For link modules   | 64   |
| 5AP923.1906-00                             | Automation Panel 19.0" SXGA TFT - 1280 x 1024 pixels (5:4) - Single-touch (analog resistive) - Control cabinet installation - Landscape format - For PPC900/PPC2100/PPC3100/PPC2200 - For link modules   | 66   |
| 5AP933.156B-00                             | Automation Panel 15.6" HD TFT - 1366 x 768 pixels (16:9) - Multi-touch (projected capacitive) - Control cabinet installation - Landscape format - For PPC900/PPC2100/PPC3100/PPC2200 - For link modules  | 69   |
| 5AP933.185B-00                             | Automation Panel 18.5" HD TFT - 1366 x 768 pixels (16:9) - Multi-touch (projected capacitive) - Control cabinet installation - Landscape format - For PPC900/PPC2100/PPC3100/PPC2200 - For link modules  | 71   |
| 5AP933.215C-00                             | Automation Panel 21.5" Full HD TFT - 1920 x 1080 pixels (16:9) - Multi-touch (projected capacitive) - Control cabinet installation - Landscape format - For PPC900/PPC2100/PPC3100/PPC2200 - For link modules  | 73   |
| 5AP933.240C-00                             | Automation Panel 24.0" Full HD TFT - 1920 x 1080 pixels (16:9) - Multi-touch (projected capacitive) - Control cabinet installation - Landscape format - For PPC900/PPC2100/PPC3100/PPC2200 - For link modules  | 75   |
| <b>System units</b>                        |  |      |
| 5PPC2100.BY01-000                          | PPC2100 system unit - Intel Atom E3815 1.46 GHz - Single core - 1 GB SDRAM - For Automation Panel 923/933/1000   | 59   |
| 5PPC2100.BY11-000                          | PPC2100 system unit - Intel Atom E3825 1.33 GHz - Dual core - 1 GB SDRAM - For Automation Panel 923/933/1000   | 59   |
| 5PPC2100.BY22-000                          | PPC2100 system unit - Intel Atom E3826 1.46 GHz - Dual core - 2 GB SDRAM - For Automation Panel 923/933/1000   | 59   |
| 5PPC2100.BY34-000                          | PPC2100 system unit - Intel Atom E3827 1.75 GHz - Dual core - 4 GB SDRAM - For Automation Panel 923/933/1000   | 59   |
| 5PPC2100.BY44-000                          | PPC2100 system unit - Intel Atom E3845 1.91 GHz - Quad core - 4 GB SDRAM - For Automation Panel 923/933/1000   | 59   |
| 5PPC2100.BY48-000                          | PPC2100 system unit - Intel Atom E3845 1.91 GHz - Quad core - 8 GB SDRAM - For Automation Panel 923/933/1000   | 59   |
| <b>Technology Guard</b>                    |  |      |
| 0TG1000.01                                 | Technology Guard (MSD)   | 237  |
| 0TG1000.02                                 | Technology Guard (HID)   | 237  |
| 1TG4600.10-5                               | Automation Runtime Windows TG license  | 237  |
| 1TG4601.06-5                               | Automation Runtime Embedded, TG license  | 237  |
| 1TG4601.06-T                               | Automation Runtime Embedded Terminal TG license  | 237  |
| <b>Terminal blocks</b>                     |  |      |
| 0TB1210.3100                               | Connector 300 VDC - 10-pin female - Cage clamp terminal block - Protected against vibration by the screw flange  | 268  |
| <b>Windows 10 IoT Enterprise 2015 LTSB</b> |  |      |
| 5SWW10.0243-MUL                            | Windows 10 IoT Enterprise 2015 LTSB - 64-bit - Multilingual - PPC2100 chipset Bay Trail - License (without Recovery DVD) - Only available with a new device  | 227  |
| <b>Windows 10 IoT Enterprise 2016 LTSB</b> |  |      |
| 5SWW10.0543-MUL                            | Windows 10 IoT Enterprise 2016 LTSB - 64-bit - Entry - Multilingual - PPC2100 chipset Bay Trail - CPU E3826/E3827/E3845 - License - Only available with a new device   | 224  |
| <b>Windows 7 Professional/Ultimate</b>     |  |      |
| 5SWWI7.1100-ENG                            | Windows 7 Professional SP1 - 32-bit - English - DVD  | 233  |
| 5SWWI7.1100-GER                            | Windows 7 Professional SP1 - 32-bit - German - DVD   | 233  |
| 5SWWI7.1200-ENG                            | Windows 7 Professional SP1 - 64-bit - English - DVD  | 233  |
| 5SWWI7.1200-GER                            | Windows 7 Professional SP1 - 64-bit - German - DVD   | 233  |
| 5SWWI7.1300-MUL                            | Windows 7 Ultimate SP1 - 32-bit - Multilingual - DVD   | 233  |
| 5SWWI7.1400-MUL                            | Windows 7 Ultimate SP1 - 64-bit - Multilingual - DVD   | 233  |
| <b>Windows Embedded 8.1 Industry Pro</b>   |  |      |
| 5SWWI8.0343-MUL                            | Windows Embedded 8.1 Industry Pro - 32-bit - Multilingual - For the PPC2100 - License  | 230  |
| 5SWWI8.0443-MUL                            | Windows Embedded 8.1 Industry Pro - 64-bit - Multilingual - For the PPC2100 - License  | 230  |
| <b>Windows Embedded Standard 7</b>         |  |      |
| 5SWWI7.1543-ENG                            | Windows Embedded Standard 7 SP1 - 32-bit - Service Pack 1 - English - PPC2100 - License (without Recovery DVD) - Only available with a new device  | 235  |
| 5SWWI7.1643-ENG                            | Windows Embedded Standard 7 SP1 - 64-bit - Service Pack 1 - English - PPC2100 - License (without Recovery DVD) - Only available with a new device  | 235  |
| 5SWWI7.1743-MUL                            | Windows Embedded Standard 7 Premium SP1 - 32-bit - Service Pack 1 - Multilingual - PPC2100 - License (without Recovery DVD) - Only available with a new device   | 235  |
| 5SWWI7.1843-MUL                            | Windows Embedded Standard 7 Premium SP1 - 64-bit - Service Pack 1 - Multilingual - PPC2100 - License (without Recovery DVD) - Only available with a new device   | 235  |

## 4 Technical data

### 4.1 Complete system

#### 4.1.1 Mechanical properties

##### 4.1.1.1 Dimensions

#### Information:

All dimensions, specifications in dimension diagrams and associated tables are in millimeters [mm].

The following diagrams are symbolic and only meant to illustrate how the dimension tables should be read.

2D and 3D data (DXF and STEP formats) can be downloaded from the B&R website ([www.br-automation.com](http://www.br-automation.com)). To do this, search for the order number of the device using the search bar.

#### AP9x3 panels - Dimensions

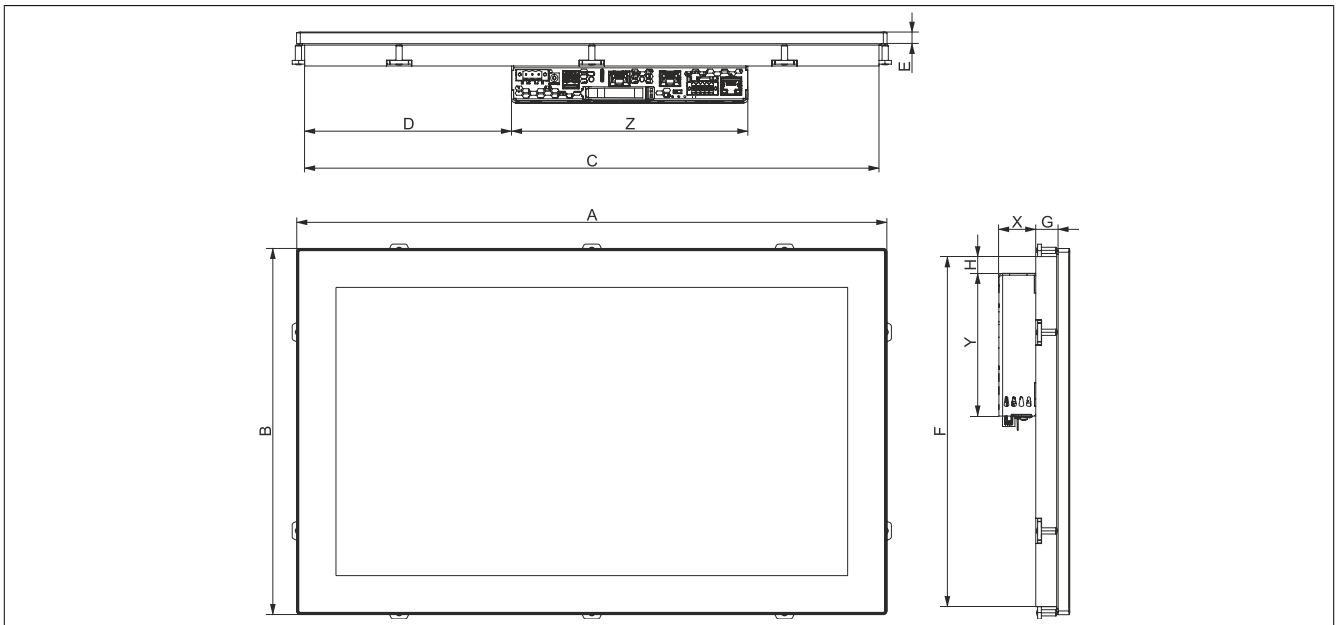

| Panels             |                   |       |       |       |        |   |       |      |      |
|--------------------|-------------------|-------|-------|-------|--------|---|-------|------|------|
| Type               | Model number      | A     | B     | C     | D      | E | F     | G    | H    |
| 12.1" single-touch | 5AP923.1215-00    | 315   | 239   | 302   | 48     | 9 | 226   | 13.5 | 13.5 |
| 15.0" single-touch | 5AP923.1505-00    | 370   | 288   | 357   | 84.5   | 9 | 275   | 14.5 | 13.5 |
| 19.0" single-touch | 5AP923.1906-00    | 440   | 358   | 427   | 149    | 9 | 345   | 23   | 13.5 |
| 15.6" multi-touch  | 5AP933.156B-00    | 414   | 258.5 | 401   | 105.5  | 9 | 245.5 | 20   | 13.5 |
| 18.5" multi-touch  | 5AP933.185B-00    | 475   | 295   | 462   | 166.5  | 9 | 282   | 18   | 13.5 |
| 21.5" multi-touch  | 5AP933.215C-00    | 541.5 | 333   | 528.5 | 199.75 | 9 | 320   | 18   | 13.5 |
| 24.0" multi-touch  | 5AP933.240C-00    | 598.5 | 364   | 585.5 | 228.25 | 9 | 351   | 18   |      |
| System units       |                   |       |       |       |        |   |       |      |      |
| Type               | Order number      | X     | Y     | Z     |        |   |       |      |      |
| System unit        | 5PPC2100.BYxx-000 | 29.7  | 115   | 190   |        |   |       |      |      |

**AP1000 panels with retaining clips - Dimensions**

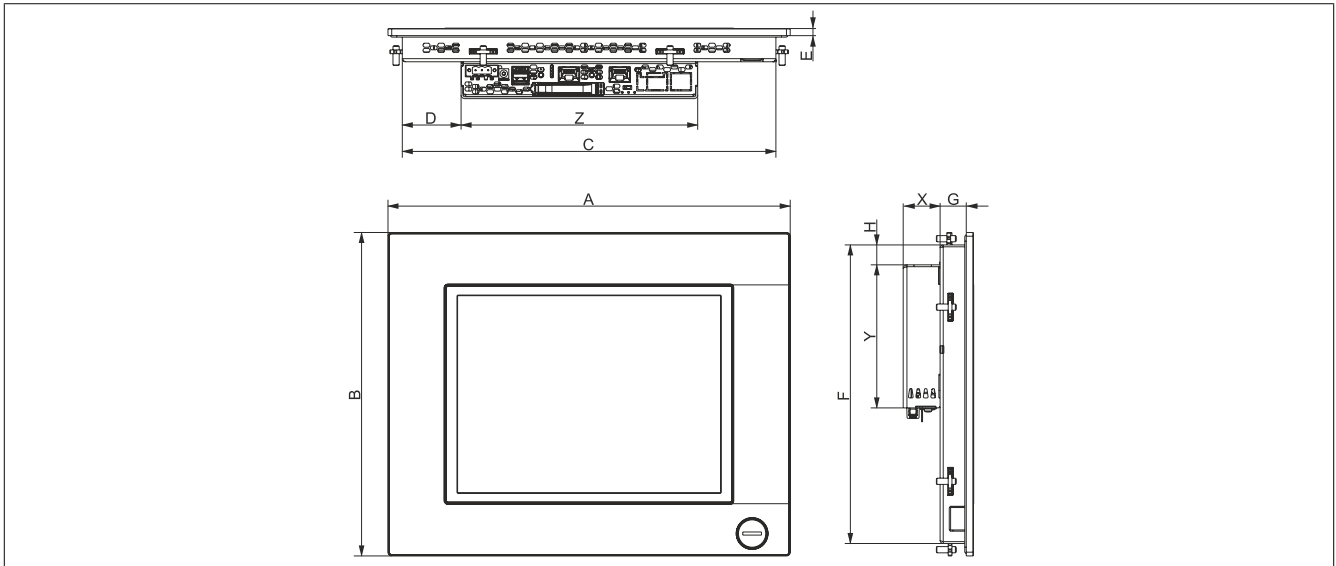

| Panels                       |                   |      |       |     |       |     |       |      |      |
|------------------------------|-------------------|------|-------|-----|-------|-----|-------|------|------|
| Type                         | Order number      | A    | B     | C   | D     | E   | F     | G    | H    |
| 5.7" single-touch            | 5AP1120.0573-000  | 212  | 156   | 196 | 3     | 5.7 | 140   | 19.5 | 2.5  |
| 5.7" with keys               | 5AP1151.0573-000  | 212  | 245   | 196 | 3     | 5.7 | 229   | 19.5 | 2.5  |
| 7.0" single-touch            | 5AP1120.0702-000  | 212  | 156   | 196 | 3     | 5.7 | 140   | 19.5 | 2.5  |
| 7.0" multi-touch             | 5AP1130.0702-000  | 209  | 153   | 196 | 3     | 9   | 140   | 20   | 7.25 |
| 10.1" single-touch           | 5AP1120.101E-000  | 279  | 191   | 266 | 38    | 9   | 178   | 18   | 13.5 |
| 10.1" multi-touch            | 5AP1130.101D-000  | 279  | 191   | 266 | 38    | 9   | 178   | 18   | 13.5 |
| 10.1" multi-touch            | 5AP1130.101E-000  | 279  | 191   | 266 | 38    | 9   | 178   | 18   | 13.5 |
| 10.4" single-touch           | 5AP1120.1043-000  | 323  | 260   | 300 | 47.2  | 5.7 | 240   | 21   | 16   |
| 10.4" single-touch with keys | 5AP1180.1043-000  | 323  | 260   | 300 | 47.2  | 5.7 | 240   | 21   | 16   |
| 12.1" single-touch           | 5AP1120.121E-000  | 324  | 221.5 | 311 | 60.5  | 9   | 208.5 | 18   | 13.5 |
| 12.1" multi-touch            | 5AP1130.121E-000  | 324  | 221.5 | 311 | 60.5  | 9   | 208.5 | 18   | 13.5 |
| 12.1" multi-touch            | 5AP1130.121E-010  | 324  | 221.5 | 311 | 60.5  | 9   | 208.5 | 18   | 13.5 |
| 15.6" single-touch           | 5AP1120.156B-000  | 414  | 258.5 | 401 | 105.5 | 9   | 245.5 | 20   | 13.5 |
| 15.6" multi-touch            | 5AP1130.156C-000  | 414  | 258.5 | 401 | 105.5 | 9   | 245.5 | 20   | 13.5 |
| 15.6" multi-touch            | 5AP1130.156C-001  | 414  | 258.5 | 401 | 105.5 | 9   | 245.5 | 20   | 13.5 |
| 18.5" multi-touch            | 5AP1130.185C-000  | 475  | 295   | 462 | 166.5 | 9   | 282   | 18   | 13.5 |
| System units                 |                   |      |       |     |       |     |       |      |      |
| Type                         | Order number      | X    | Y     | Z   |       |     |       |      |      |
| System unit                  | 5PPC2100.BYxx-000 | 29.7 | 115   | 190 |       |     |       |      |      |

AP1000 panels with clamping blocks - Dimensions

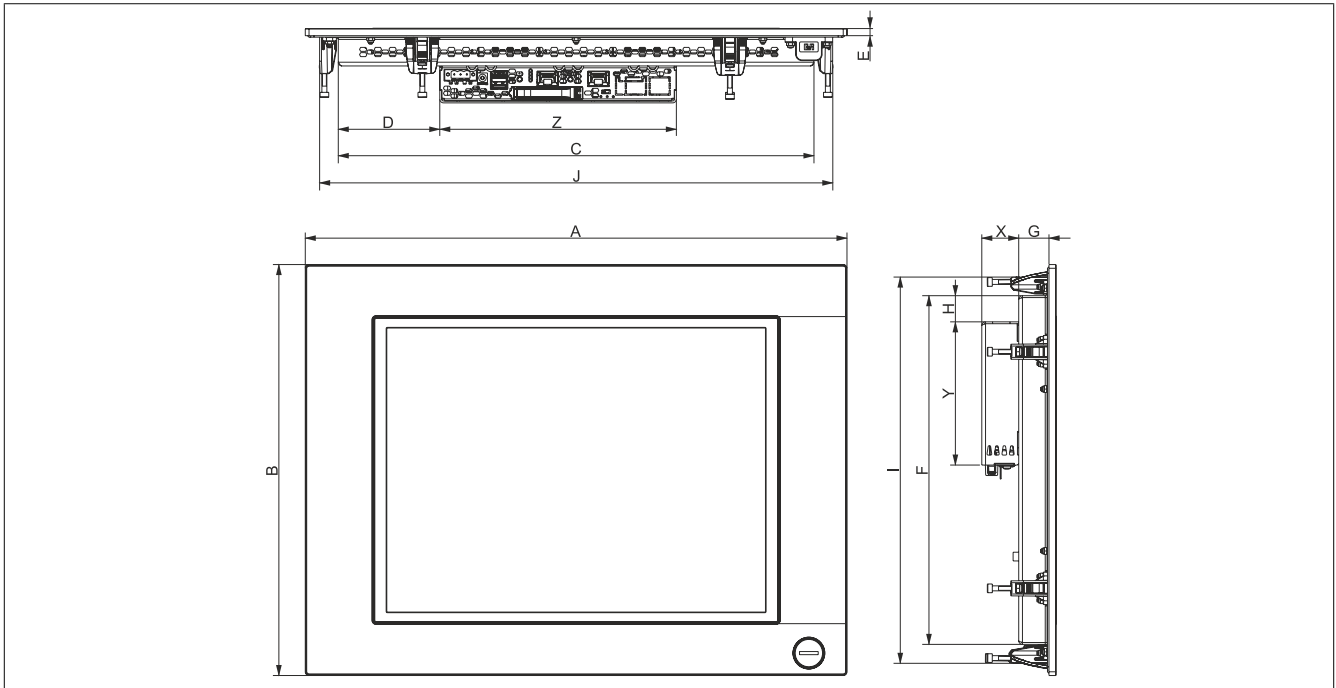

| Panels                       |                   |      |     |       |       |     |     |      |      |     |     |
|------------------------------|-------------------|------|-----|-------|-------|-----|-----|------|------|-----|-----|
| Type                         | Order number      | A    | B   | C     | D     | E   | F   | G    | H    | I   | J   |
| 10.4" single-touch with keys | 5AP1181.1043-000  | 323  | 358 | 270   | 70.5  | 5.7 | 305 | 21.3 | 17.5 | 338 | 300 |
| 10.4" single-touch with keys | 5AP1182.1043-000  | 423  | 288 | 355.5 | 70.5  | 5.7 | 234 | 21.3 | 17.5 | 268 | 400 |
| 12.1" single-touch           | 5AP1120.1214-000  | 362  | 284 | 309   | 52.5  | 5.7 | 234 | 20.3 | 17.5 | 264 | 339 |
| 15.0" single-touch           | 5AP1120.1505-000  | 435  | 330 | 382   | 81.5  | 5.7 | 280 | 24.3 | 24   | 310 | 412 |
| 15.0" single-touch with keys | 5AP1180.1505-000  | 435  | 330 | 382   | 81.5  | 5.7 | 280 | 24.3 | 24   | 310 | 412 |
| 15.0" single-touch with keys | 5AP1181.1505-000  | 435  | 330 | 382   | 81.5  | 5.7 | 280 | 24.3 | 24   | 310 | 412 |
| 19.0" single-touch           | 5AP1120.1906-000  | 527  | 421 | 445   | 186.5 | 5.7 | 351 | 23.3 | 19.3 | 401 | 507 |
| System units                 |                   |      |     |       |       |     |     |      |      |     |     |
| Type                         | Order number      | X    | Y   | Z     |       |     |     |      |      |     |     |
| System unit                  | 5PPC2100.BYxx-000 | 29.7 | 115 | 190   |       |     |     |      |      |     |     |

### 4.1.1.2 Mounting orientations

#### Information:

When installing the Panel PC 2100, spacing for air circulation and additional free space for operating and servicing the device must be taken into account.

All specifications in dimension diagrams and associated tables are in millimeters [mm].

The cutout tolerances are +0 mm / -0.5 mm.

#### AP9x3 panels - Installation diagrams

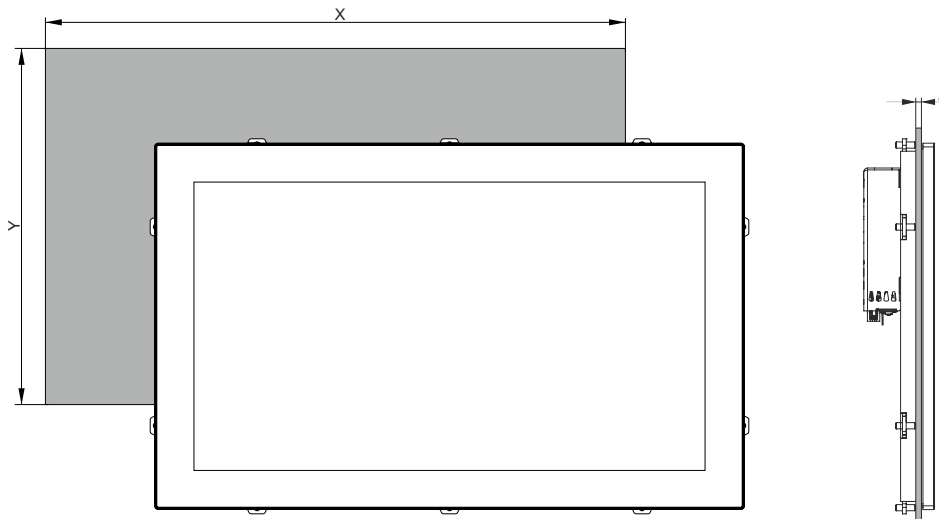

| Panels             |                |       |       |        |        |                           |
|--------------------|----------------|-------|-------|--------|--------|---------------------------|
| Type               | Model number   | X     | Y     | Z min. | Z max. | Number of retaining clips |
| 12.1" single-touch | 5AP923.1215-00 | 304   | 228   | 1      | 6      | 10                        |
| 15.0" single-touch | 5AP923.1505-00 | 359   | 277   | 1      | 6      | 10                        |
| 19.0" single-touch | 5AP923.1906-00 | 429   | 347   | 1      | 6      | 12                        |
| 15.6" multi-touch  | 5AP933.156B-00 | 403   | 247.5 | 1      | 6      | 10                        |
| 18.5" multi-touch  | 5AP933.185B-00 | 464   | 284   | 1      | 6      | 10                        |
| 21.5" multi-touch  | 5AP933.215C-00 | 530.5 | 322   | 1      | 6      | 14                        |
| 24.0" multi-touch  | 5AP933.240C-00 | 587.5 | 353   | 1      | 6      | 14                        |

Dimension "Z" describes the thickness of the wall or control cabinet plate.

A hex screwdriver is needed to tighten and loosen the screw on the retaining clips. The maximum tightening torque of the retaining clips is 1 Nm.

AP1000 panels with retaining clips - Installation diagrams

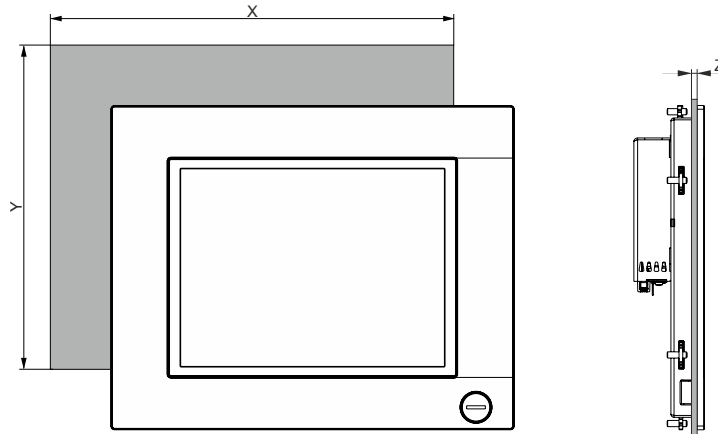

| Panels                       |                  |     |       |        |        |                           |
|------------------------------|------------------|-----|-------|--------|--------|---------------------------|
| Type                         | Model number     | X   | Y     | Z min. | Z max. | Number of retaining clips |
| 5.7" single-touch            | 5AP1120.0573-000 | 199 | 143   | 1      | 8      | 4                         |
| 5.7" with buttons            | 5AP1151.0573-000 | 199 | 232   | 1      | 8      | 6                         |
| 7.0" single-touch            | 5AP1120.0702-000 | 199 | 143   | 1      | 8      | 4                         |
| 7.0" multi-touch             | 5AP1130.0702-000 | 199 | 143   | 1      | 8      | 4                         |
| 10.1" single-touch           | 5AP1120.101E-000 | 268 | 180   | 1      | 6      | 8                         |
| 10.1" multi-touch            | 5AP1130.101D-000 | 268 | 180   | 1      | 6      | 8                         |
| 10.1" multi-touch            | 5AP1130.101E-000 | 268 | 180   | 1      | 6      | 8                         |
| 10.4" single-touch           | 5AP1120.1043-000 | 303 | 243   | 1      | 10     | 8                         |
| 10.4" single-touch with keys | 5AP1180.1043-000 | 303 | 243   | 1      | 10     | 8                         |
| 12.1" single-touch           | 5AP1120.121E-000 | 313 | 210.5 | 1      | 6      | 10                        |
| 12.1" multi-touch            | 5AP1130.121E-000 | 313 | 210.5 | 1      | 6      | 10                        |
| 12.1" multi-touch            | 5AP1130.121E-010 | 313 | 210.5 | 1      | 6      | 10                        |
| 15.6" single-touch           | 5AP1120.156B-000 | 403 | 247.5 | 1      | 6      | 10                        |
| 15.6" multi-touch            | 5AP1130.156C-000 | 403 | 247.5 | 1      | 6      | 10                        |
| 15.6" multi-touch            | 5AP1130.156C-001 | 403 | 247.5 | 1      | 6      | 10                        |
| 18.5" multi-touch            | 5AP1130.185C-000 | 464 | 284   | 1      | 6      | 10                        |

Dimension "Z" describes the thickness of the wall or control cabinet plate.

A 2.5 mm hex screwdriver is needed to tighten and remove the screw on the retaining clips. The maximum tightening torque of the retaining clips is 1 Nm.

**Information:**

**A minimum circumferential distance of 30 mm must be maintained in order to enable installation with retaining clips.**

**AP1000 panels with clamping blocks - Installation diagrams**

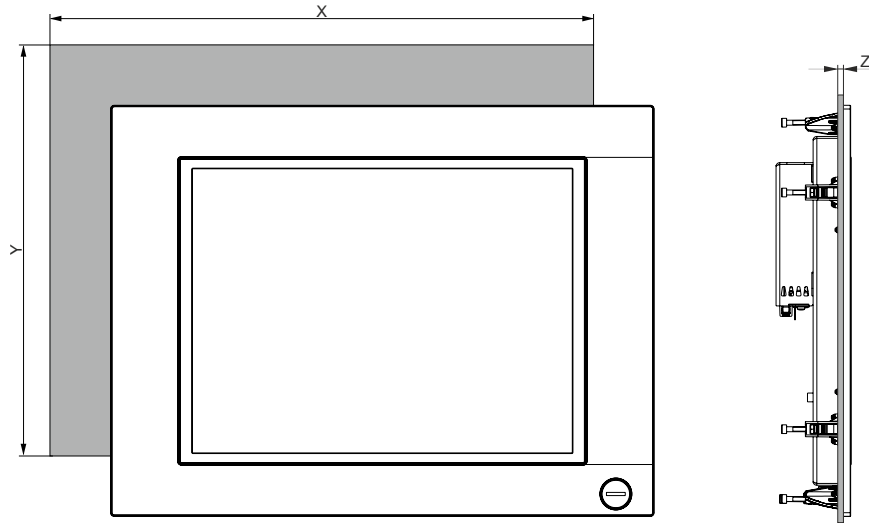

| Panels                       |                  |     |     |        |        |                           |
|------------------------------|------------------|-----|-----|--------|--------|---------------------------|
| Type                         | Model number     | X   | Y   | Z min. | Z max. | Number of clamping blocks |
| 10.4" single-touch with keys | 5AP1181.1043-000 | 303 | 341 | 2      | 10     | 10                        |
| 10.4" single-touch with keys | 5AP1182.1043-000 | 403 | 271 | 2      | 10     | 8                         |
| 12.1" single-touch           | 5AP1120.1214-000 | 342 | 267 | 2      | 10     | 8                         |
| 15.0" single-touch           | 5AP1120.1505-000 | 415 | 313 | 2      | 10     | 8                         |
| 15.0" single-touch with keys | 5AP1180.1505-000 | 415 | 313 | 2      | 10     | 8                         |
| 15.0" single-touch with keys | 5AP1181.1505-000 | 415 | 413 | 2      | 10     | 10                        |
| 19.0" single-touch           | 5AP1120.1906-000 | 510 | 404 | 2      | 10     | 12                        |

Dimension "Z" describes the thickness of the wall or control cabinet plate.

A 3 mm hex screwdriver is needed to tighten or remove the screw on the clamping blocks. The maximum tightening torque of the clamping block is 0.5 Nm.

### 4.1.1.3 Spacing for air circulation

To ensure sufficient air circulation, a specified clearance must be provided above, below, to the side and behind the device. For the minimum specified clearance, see the following diagrams. This is valid for all variants.

#### Information:

The following figure and table exclusively show the thermal view of the complete system. If additional space is required for operating or servicing the device, this must be taken into account during installation.

The air intake and outlet are indicated in the following image. The air intake is located on the bottom to accommodate the rising warm air.

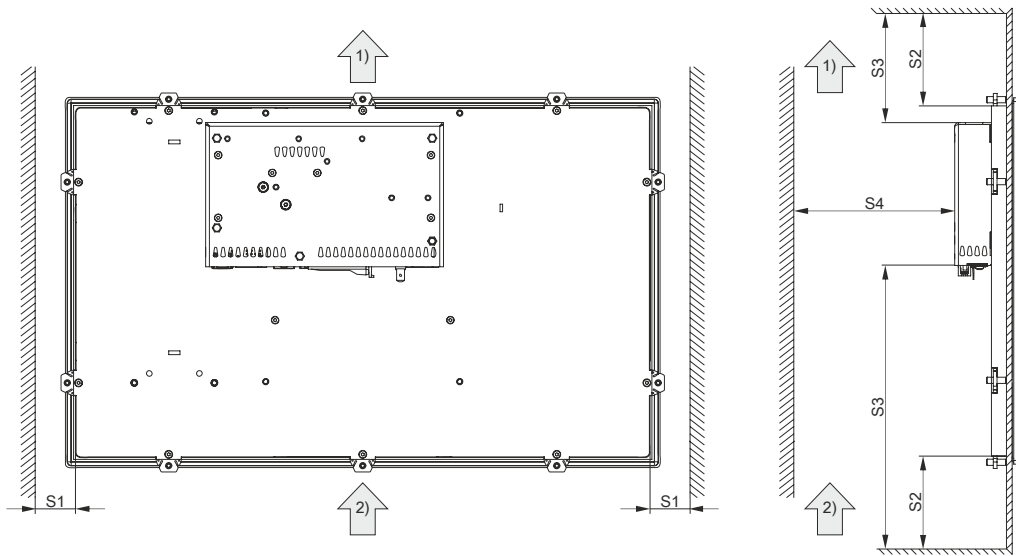

| Legend |            |      |           |
|--------|------------|------|-----------|
| 1)     | Air outlet | 2)   | Air inlet |
| Name   | Dimension  | Name | Dimension |
| S1     | ≥20        | S2   | ≥50       |
| S3     | ≥100       | S4   | ≥50       |

#### Caution!

The specified spacing for air circulation is based on worst-case operation at the maximum specified ambient temperature. The maximum specified ambient temperature is not permitted to be exceeded!

If the spacing specifications for air circulation cannot be observed, then the maximum specified temperatures for the temperature sensors (see ["Temperature sensor positions"](#) on page 41) must be monitored by the user and appropriate measures taken if they are exceeded.

#### 4.1.1.4 Mounting orientations

The following figures show the specified mounting orientations of Panel PC 2100 devices. A PPC2100 is only permitted to be installed as shown and described below.

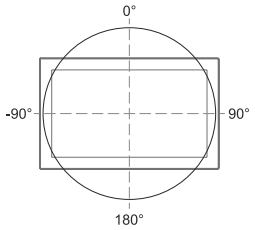
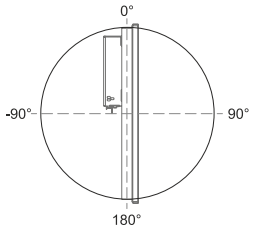
|   | Inclination [°] | Derating [°C] |  | Inclination [°] | Derating      |
|---|-----------------|---------------|--|-----------------|---------------|
|  | 0               | No limitation |  | 0               | No limitation |
|   | Up to ±90       | -5            |  | Up to +90       | -10           |
|   | 180             | -5            |  | Up to -45       | -5            |
|   |                 |               |  | Up to -90       | -10           |
|   |                 |               | 180  | -5              |               |

During installation, it is important to make sure that the spacing as described in section "[Spacing for air circulation](#)" on page 31 is observed in order to achieve natural air circulation.

### 4.1.1.5 Weight specifications

#### AP9x3 panels

| Type               | Order number   | Weight [g] |
|--------------------|----------------|------------|
| 12.1" single-touch | 5AP923.1215-00 | 2200       |
| 15.0" single-touch | 5AP923.1505-00 | 3700       |
| 19.0" single-touch | 5AP923.1906-00 | 5800       |
| 15.6" multi-touch  | 5AP933.156B-00 | 3850       |
| 18.5" multi-touch  | 5AP933.185B-00 | 4850       |
| 21.5" multi-touch  | 5AP933.215C-00 | 5400       |
| 24.0" multi-touch  | 5AP933.240C-00 | 7800       |

#### AP1000 panels

| Type                         | Model number     | Weight [g] |
|------------------------------|------------------|------------|
| 5.7" single-touch            | 5AP1120.0573-000 | 1100       |
| 5.7" keys                    | 5AP1151.0573-000 | 1400       |
| 7.0" single-touch            | 5AP1120.0702-000 | 900        |
| 7.0" multi-touch             | 5AP1130.0702-000 | 1200       |
| 10.1" multi-touch            | 5AP1130.101D-000 | 2000       |
| 10.1" single-touch           | 5AP1120.101E-000 | 1900       |
| 10.1" multi-touch            | 5AP1130.101E-000 | 2000       |
| 10.4" single-touch           | 5AP1120.1043-000 | 2800       |
| 10.4" single-touch with keys | 5AP1180.1043-000 | 2800       |
| 10.4" single-touch with keys | 5AP1181.1043-000 | 3400       |
| 10.4" single-touch with keys | 5AP1182.1043-000 | 3500       |
| 12.1" single-touch           | 5AP1120.1214-000 | 3200       |
| 12.1" single-touch           | 5AP1120.121E-000 | 2300       |
| 12.1" multi-touch            | 5AP1130.121E-000 | 2400       |
| 12.1" multi-touch            | 5AP1130.121E-010 | 2900       |
| 15.0" single-touch           | 5AP1120.1505-000 | 5000       |
| 15.0" single-touch with keys | 5AP1180.1505-000 | 4900       |
| 15.0" single-touch with keys | 5AP1181.1505-000 | 6000       |
| 15.6" single-touch           | 5AP1120.156B-000 | 4200       |
| 15.6" multi-touch            | 5AP1130.156C-000 | 3700       |
| 15.6" multi-touch            | 5AP1130.156C-001 | 3800       |
| 18.5" multi-touch            | 5AP1130.185C-000 | 4700       |
| 19.0" single-touch           | 5AP1120.1906-000 | 7300       |

#### System units and components

| Component         | Model number      | Weight [g] |
|-------------------|-------------------|------------|
| System units      | 5PPC2100.BYxx-000 | 577        |
| CFast cards       | 5CFAST.xxxx-00    | 10         |
|                   | 5CFAST.xxxx-10    | 10         |
| Interface options | 5ACCIF01.FPCC-000 | 25         |
|                   | 5ACCIF01.FPCS-000 | 25         |
|                   | 5ACCIF01.FPLK-000 | 25         |
|                   | 5ACCIF01.FPLS-000 | 25         |
|                   | 5ACCIF01.FPLS-001 | 25         |
|                   | 5ACCIF01.FPSC-000 | 25         |
|                   | 5ACCIF01.FPSC-001 | 25         |
|                   | 5ACCIF01.FSS0-000 | 25         |
|                   | 5ACCIF01.ICAN-000 | 25         |
|                   | 5ACCIF01.IS00-000 | 25         |

## 4.1.2 Environmental properties

### 4.1.2.1 Temperature specifications

Various system units can be combined with a panel. The many different configurations possible result in varying minimum, maximum and typical ambient temperatures, which can be seen in the following tables in this section.

#### **Information:**

**The minimum and maximum specified ambient temperatures were determined under worst-case conditions for operation. Experience has shown that higher ambient temperatures can be achieved with typical applications in Microsoft Windows, for example. The relevant test and assessment must be carried out individually by the user on site (reading out the temperatures in BIOS or using the B&R Control Center, for example).**

#### **Information regarding worst-case conditions**

- Thermal Analysis Tool (TAT V4.3.4.13.01) from Intel for simulating a 100% processor load
- BurnInTest tool (BurnInTest V7.0 Pro from PassMark Software) for simulating a 100% load on the interface using loopback adapters (USB interfaces)
- Maximum system expansion and power consumption

### 4.1.2.1.1 Maximum ambient temperature for worst-case operation

All specifications apply to non-condensing operation.

| All temperature specifications in degrees Celsius [°C] at 500 m above sea level, <b>non-condensing</b> .     |   | Maximum ambient temperature (system unit 5PPC2100.BYxx-000) |   |   |  |  |    |
|--|---|---|---|---|--|--|----|
| The respective ambient temperature is derated approx. 1°C per 1000 meters starting at 500 m above sea level. | 5PPC2100.<br>BY01-000<br>(E3930<br>1.3 GHz) | 5PPC2100.<br>BY11-000<br>(E3930<br>1.3 GHz)                 | 5PPC2100.<br>BY22-000<br>(E3940<br>1.6 GHz) | 5PPC2100.<br>BY34-000<br>(E3940<br>1.6 GHz) | 5PPC2100.<br>BY44-000<br>(E3845<br>1,91 GHz) | 5PPC2100.<br>BY48-000<br>(E3845<br>1.91 GHz) |    |
|  | 55  | 55  | 55  | 50  | 50   | 50   |    |
| <b>Maximum ambient temperature (accessories)</b>   |   |   |   |   |  |  |    |
| <b>AP9x3 panels</b>  | 5AP923.1215-00                              | ✓   | ✓   | ✓   | ✓  | ✓  | ✓  |
|  | 5AP923.1505-00                              | ✓   | ✓   | ✓   | ✓  | ✓  | ✓  |
|  | 5AP923.1906-00 ≤ D0                         | 50  | 50  | 50  | ✓  | ✓  | ✓  |
|  | 5AP923.1906-00 ≥ E0                         | ✓   | ✓   | ✓   | ✓  | ✓  | ✓  |
|  | 5AP933.156B-00 ≤ C0                         | 50  | 50  | 50  | ✓  | ✓  | ✓  |
|  | 5AP933.156B-00 ≥ D0                         | ✓   | ✓   | ✓   | ✓  | ✓  | ✓  |
|  | 5AP933.185B-00                              | 50  | 50  | 50  | ✓  | ✓  | ✓  |
|  | 5AP933.215C-00 ≤ C0                         | 40  | 40  | 40  | 40   | 40   | 40 |
|  | 5AP933.215C-00 ≥ D0                         | 50  | 50  | 50  | ✓  | ✓  | ✓  |
|  | 5AP933.240C-00 ≤ C0                         | 40  | 40  | 40  | 40   | 40   | 40 |
| 5AP933.240C-00 ≥ D0  | ✓   | ✓   | ✓   | ✓   | ✓  | ✓  |    |
| <b>AP1000 panels</b>   | 5AP1120.0573-000                            | ✓   | ✓   | ✓   | ✓  | ✓  | ✓  |
|  | 5AP1151.0573-000                            | ✓   | ✓   | ✓   | ✓  | ✓  | ✓  |
|  | 5AP1120.0702-000                            | ✓   | ✓   | ✓   | ✓  | ✓  | ✓  |
|  | 5AP1130.0702-000                            | ✓   | ✓   | ✓   | ✓  | ✓  | ✓  |
|  | 5AP1130.101D-000                            | ✓   | ✓   | ✓   | ✓  | ✓  | ✓  |
|  | 5AP1120.101E-000                            | ✓   | ✓   | ✓   | ✓  | ✓  | ✓  |
|  | 5AP1130.101E-000                            | ✓   | ✓   | ✓   | ✓  | ✓  | ✓  |
|  | 5AP1120.1043-000                            | ✓   | ✓   | ✓   | ✓  | ✓  | ✓  |
|  | 5AP1180.1043-000                            | ✓   | ✓   | ✓   | ✓  | ✓  | ✓  |
|  | 5AP1181.1043-000                            | ✓   | ✓   | ✓   | ✓  | ✓  | ✓  |
|  | 5AP1182.1043-000                            | ✓   | ✓   | ✓   | ✓  | ✓  | ✓  |
|  | 5AP1120.1214-000                            | ✓   | ✓   | ✓   | ✓  | ✓  | ✓  |
|  | 5AP1120.121E-000                            | ✓   | ✓   | ✓   | ✓  | ✓  | ✓  |
|  | 5AP1130.121E-000                            | ✓   | ✓   | ✓   | ✓  | ✓  | ✓  |
|  | 5AP1130.121E-010                            | 50  | 50  | 50  | 45   | 45   | 45 |
|  | 5AP1120.1505-000                            | ✓   | ✓   | ✓   | ✓  | ✓  | ✓  |
|  | 5AP1180.1505-000                            | ✓   | ✓   | ✓   | ✓  | ✓  | ✓  |
|  | 5AP1181.1505-000                            | ✓   | ✓   | ✓   | ✓  | ✓  | ✓  |
|  | 5AP1120.156B-000                            | ✓   | ✓   | ✓   | ✓  | ✓  | ✓  |
|  | 5AP1130.156C-000                            | 50  | 50  | 50  | 45   | 45   | 45 |
| 5AP1130.156C-001   | 50  | 50  | 50  | 45  | 45   | 45   |    |
| 5AP1130.185C-000   | 50  | 50  | 50  | 45  | 45   | 45   |    |
| 5AP1120.1906-000   | ✓   | ✓   | ✓   | ✓   | ✓  | ✓  |    |
| <b>CFast cards</b>   | 5CFAST.xxxx-00<br>≥ Rev. E0                 | ✓   | ✓   | ✓   | ✓  | ✓  | ✓  |
|  | 5CFAST.xxxx-10                              | ✓   | ✓   | ✓   | ✓  | ✓  | ✓  |
| <b>Interface options</b>   | 5ACCIF01.FPCC-000                           | ✓   | ✓   | ✓   | ✓  | ✓  | ✓  |
|  | 5ACCIF01.FPCS-000                           | ✓   | ✓   | ✓   | ✓  | ✓  | ✓  |
|  | 5ACCIF01.FPLK-000                           | ✓   | ✓   | ✓   | ✓  | ✓  | ✓  |
|  | 5ACCIF01.FPLS-000                           | ✓   | ✓   | ✓   | ✓  | ✓  | ✓  |
|  | 5ACCIF01.FPLS-001                           | ✓   | ✓   | ✓   | ✓  | ✓  | ✓  |
|  | 5ACCIF01.FPSC-000                           | ✓   | ✓   | ✓   | ✓  | ✓  | ✓  |
|  | 5ACCIF01.FPSC-001                           | ✓   | ✓   | ✓   | ✓  | ✓  | ✓  |
|  | 5ACCIF01.FSS0-000                           | ✓   | ✓   | ✓   | ✓  | ✓  | ✓  |
|  | 5ACCIF01.ICAN-000                           | ✓   | ✓   | ✓   | ✓  | ✓  | ✓  |
| 5ACCIF01.IS00-000  | ✓   | ✓   | ✓   | ✓   | ✓  | ✓  |    |

4.1.2.1.2 Minimum ambient temperature for worst-case operation

| All temperature specifications in degrees Celsius [°C] at 500 m above sea level, <b>non-condensing</b> . |                             | Minimum ambient temperature (system unit 5PPC2100.BYxx-000) |  |  |  |  |  |
|--|-----------------------------|---|--|--|--|--|--|
|  |                             | 5PPC2100.<br>BY01-000<br>(E3815<br>1.46 GHz)                | 5PPC2100.<br>BY11-000<br>(E3825<br>1.33 GHz) | 5PPC2100.<br>BY22-000<br>(E3826<br>1.46 GHz) | 5PPC2100.<br>BY34-000<br>(E3927<br>1.75 GHz) | 5PPC2100.<br>BY44-000<br>(E3845<br>1.91 GHz) | 5PPC2100.<br>BY48-000<br>(E3845<br>1.91 GHz) |
|  |                             | -20   | -20  | -20  | -20  | -20  | -20  |
| <b>Minimum ambient temperature (accessories)</b>   |                             |   |  |  |  |  |  |
| AP9x3 panels   | 5AP923.1215-00              | ✓   | ✓  | ✓  | ✓  | ✓  | ✓  |
|  | 5AP923.1505-00              | ✓   | ✓  | ✓  | ✓  | ✓  | ✓  |
|  | 5AP923.1906-00 ≤ D0         | 0   | 0  | 0  | 0  | 0  | 0  |
|  | 5AP923.1906-00 ≥ E0         | ✓   | ✓  | ✓  | ✓  | ✓  | ✓  |
|  | 5AP933.156B-00 ≤ C0         | 0   | 0  | 0  | 0  | 0  | 0  |
|  | 5AP933.156B-00 ≥ D0         | -10   | -10  | -10  | -10  | -10  | -10  |
|  | 5AP933.185B-00              | 0   | 0  | 0  | 0  | 0  | 0  |
|  | 5AP933.215C-00              | 0   | 0  | 0  | 0  | 0  | 0  |
|  | 5AP933.240C-00 ≤ C0         | 0   | 0  | 0  | 0  | 0  | 0  |
| 5AP933.240C-00 ≥ D0  | -10                         | -10   | -10  | -10  | -10  | -10  |  |
| AP1000 panels  | 5AP1120.0573-000            | -10   | -10  | -10  | -10  | -10  | -10  |
|  | 5AP1151.0573-000            | 0   | 0  | 0  | 0  | 0  | 0  |
|  | 5AP1120.0702-000            | ✓   | ✓  | ✓  | ✓  | ✓  | ✓  |
|  | 5AP1130.0702-000            | -10   | -10  | -10  | -10  | -10  | -10  |
|  | 5AP1130.101D-000            | -10   | -10  | -10  | -10  | -10  | -10  |
|  | 5AP1120.101E-000            | ✓   | ✓  | ✓  | ✓  | ✓  | ✓  |
|  | 5AP1130.101E-000            | -10   | -10  | -10  | -10  | -10  | -10  |
|  | 5AP1120.1043-000            | ✓   | ✓  | ✓  | ✓  | ✓  | ✓  |
|  | 5AP1180.1043-000            | ✓   | ✓  | ✓  | ✓  | ✓  | ✓  |
|  | 5AP1181.1043-000            | ✓   | ✓  | ✓  | ✓  | ✓  | ✓  |
|  | 5AP1182.1043-000            | ✓   | ✓  | ✓  | ✓  | ✓  | ✓  |
|  | 5AP1120.1214-000            | ✓   | ✓  | ✓  | ✓  | ✓  | ✓  |
|  | 5AP1120.121E-000            | ✓   | ✓  | ✓  | ✓  | ✓  | ✓  |
|  | 5AP1130.121E-000            | -10   | -10  | -10  | -10  | -10  | -10  |
|  | 5AP1130.121E-010            | -10   | -10  | -10  | -10  | -10  | -10  |
|  | 5AP1120.1505-000            | ✓   | ✓  | ✓  | ✓  | ✓  | ✓  |
|  | 5AP1180.1505-000            | ✓   | ✓  | ✓  | ✓  | ✓  | ✓  |
|  | 5AP1181.1505-000            | ✓   | ✓  | ✓  | ✓  | ✓  | ✓  |
|  | 5AP1120.156B-000            | ✓   | ✓  | ✓  | ✓  | ✓  | ✓  |
|  | 5AP1130.156C-000            | -10   | -10  | -10  | -10  | -10  | -10  |
| 5AP1130.156C-001   | -10                         | -10   | -10  | -10  | -10  | -10  |  |
| 5AP1130.185C-000   | -10                         | -10   | -10  | -10  | -10  | -10  |  |
| 5AP1120.1906-000   | ✓                           | ✓   | ✓  | ✓  | ✓  | ✓  |  |
| CFast cards  | 5CFAST.xxxx-00<br>≥ Rev. E0 | ✓   | ✓  | ✓  | ✓  | ✓  | ✓  |
|  | 5CFAST.xxxx-10              | ✓   | ✓  | ✓  | ✓  | ✓  | ✓  |
| Interface options  | 5ACCIF01.FPCC-000           | ✓   | ✓  | ✓  | ✓  | ✓  | ✓  |
|  | 5ACCIF01.FPCS-000           | ✓   | ✓  | ✓  | ✓  | ✓  | ✓  |
|  | 5ACCIF01.FPLK-000           | ✓   | ✓  | ✓  | ✓  | ✓  | ✓  |
|  | 5ACCIF01.FPLS-000           | ✓   | ✓  | ✓  | ✓  | ✓  | ✓  |
|  | 5ACCIF01.FPLS-001           | ✓   | ✓  | ✓  | ✓  | ✓  | ✓  |
|  | 5ACCIF01.FPSC-000           | ✓   | ✓  | ✓  | ✓  | ✓  | ✓  |
|  | 5ACCIF01.FPSC-001           | ✓   | ✓  | ✓  | ✓  | ✓  | ✓  |
|  | 5ACCIF01.FSS0-000           | ✓   | ✓  | ✓  | ✓  | ✓  | ✓  |
|  | 5ACCIF01.ICAN-000           | ✓   | ✓  | ✓  | ✓  | ✓  | ✓  |
| 5ACCIF01.IS00-000  | ✓                           | ✓   | ✓  | ✓  | ✓  | ✓  |  |

### 4.1.2.1.3 Maximum ambient temperature for typical operation

#### Information regarding typical conditions

- The total power of all system unit USB interfaces is limited to 1 W.
- 2x Gigabit Ethernet
- No permanent 100% processor load and graphics load
- The power consumption of the entire system is limited to 45 W. For information about the power consumption of individual components, see 4.1.3.2 "Power calculation".

| All temperature specifications in degrees Celsius [°C] at 500 m above sea level, non-condensing.             |                             | Maximum ambient temperature for typical operation (system unit 5PPC2100.BYxx-000) |  |  |  |  |  |
|--|-----------------------------|---|--|--|--|--|--|
| The respective ambient temperature is derated approx. 1°C per 1000 meters starting at 500 m above sea level. |                             | 5PPC2100.<br>BY01-000<br>(E3815<br>1.46 GHz)                                      | 5PPC2100.<br>BY11-000<br>(E3825<br>1.33 GHz) | 5PPC2100.<br>BY22-000<br>(E3826<br>1.46 GHz) | 5PPC2100.<br>BY34-000<br>(E3827<br>1.75 GHz) | 5PPC2100.<br>BY44-000<br>(E3845<br>1.91 GHz) | 5PPC2100.<br>BY48-000<br>(E3845<br>1.91 GHz) |
|  |                             | 60  | 60   | 60   | 55   | 55   | 55   |
| <b>Maximum ambient temperature (accessories)</b>   |                             |   |  |  |  |  |  |
| <b>AP9x3 panels</b>  | 5AP923.1215-00              | ✓   | ✓  | ✓  | ✓  | ✓  | ✓  |
|  | 5AP923.1505-00              | ✓   | ✓  | ✓  | ✓  | ✓  | ✓  |
|  | 5AP923.1906-00 ≤ D0         | 50  | 50   | 50   | 50   | 50   | 50   |
|  | 5AP923.1906-00 ≥ E0         | 55  | 55   | 55   | ✓  | ✓  | ✓  |
|  | 5AP933.156B-00 ≤ C0         | 50  | 50   | 50   | 50   | 50   | 50   |
|  | 5AP933.156B-00 ≥ D0         | 55  | 55   | 55   | ✓  | ✓  | ✓  |
|  | 5AP933.185B-00              | 50  | 50   | 50   | 50   | 50   | 50   |
|  | 5AP933.215C-00 ≤ C0         | 40  | 40   | 40   | 40   | 40   | 40   |
|  | 5AP933.215C-00 ≥ D0         | 50  | 50   | 50   | 50   | 50   | 50   |
|  | 5AP933.240C-00 ≤ C0         | 40  | 40   | 40   | 40   | 40   | 40   |
| 5AP933.240C-00 ≥ D0  | 55                          | 55  | 55   | ✓  | ✓  | ✓  |  |
| <b>AP1000 panels</b>   | 5AP1120.0573-000            | 55  | 55   | 55   | ✓  | ✓  | ✓  |
|  | 5AP1151.0573-000            | 55  | 55   | 55   | ✓  | ✓  | ✓  |
|  | 5AP1120.0702-000            | ✓   | ✓  | ✓  | ✓  | ✓  | ✓  |
|  | 5AP1130.0702-000            | 55  | 55   | 55   | ✓  | ✓  | ✓  |
|  | 5AP1130.101D-000            | 55  | 55   | 55   | ✓  | ✓  | ✓  |
|  | 5AP1120.101E-000            | 55  | 55   | 55   | ✓  | ✓  | ✓  |
|  | 5AP1130.101E-000            | 55  | 55   | 55   | ✓  | ✓  | ✓  |
|  | 5AP1120.1043-000            | ✓   | ✓  | ✓  | ✓  | ✓  | ✓  |
|  | 5AP1180.1043-000            | ✓   | ✓  | ✓  | ✓  | ✓  | ✓  |
|  | 5AP1181.1043-000            | ✓   | ✓  | ✓  | ✓  | ✓  | ✓  |
|  | 5AP1182.1043-000            | ✓   | ✓  | ✓  | ✓  | ✓  | ✓  |
|  | 5AP1120.1214-000            | ✓   | ✓  | ✓  | ✓  | ✓  | ✓  |
|  | 5AP1120.121E-000            | ✓   | ✓  | ✓  | ✓  | ✓  | ✓  |
|  | 5AP1130.121E-000            | 55  | 55   | 55   | ✓  | ✓  | ✓  |
|  | 5AP1130.121E-010            | 55  | 55   | 55   | 50   | 50   | 50   |
|  | 5AP1120.1505-000            | ✓   | ✓  | ✓  | ✓  | ✓  | ✓  |
|  | 5AP1180.1505-000            | ✓   | ✓  | ✓  | ✓  | ✓  | ✓  |
|  | 5AP1181.1505-000            | ✓   | ✓  | ✓  | ✓  | ✓  | ✓  |
|  | 5AP1120.156B-000            | 55  | 55   | 55   | ✓  | ✓  | ✓  |
|  | 5AP1130.156C-000            | 55  | 55   | 55   | 50   | 50   | 50   |
| 5AP1130.156C-001   | 55                          | 55  | 55   | 50   | 50   | 50   |  |
| 5AP1130.185C-000   | 55                          | 55  | 55   | 50   | 50   | 50   |  |
| 5AP1120.1906-000   | 55                          | 55  | 55   | ✓  | ✓  | ✓  |  |
| <b>CFast cards</b>   | 5CFAST.xxxx-00<br>≥ Rev. E0 | 55  | 55   | 55   | ✓  | ✓  | ✓  |
|  | 5CFAST.xxxx-10              | 55  | 55   | 55   | ✓  | ✓  | ✓  |
| <b>Interface options</b>   | 5ACCIF01.FPCC-000           | ✓   | ✓  | ✓  | ✓  | ✓  | ✓  |
|  | 5ACCIF01.FPCS-000           | ✓   | ✓  | ✓  | ✓  | ✓  | ✓  |
|  | 5ACCIF01.FPLK-000           | ✓   | ✓  | ✓  | ✓  | ✓  | ✓  |
|  | 5ACCIF01.FPLS-000           | ✓   | ✓  | ✓  | ✓  | ✓  | ✓  |
|  | 5ACCIF01.FPLS-001           | ✓   | ✓  | ✓  | ✓  | ✓  | ✓  |
|  | 5ACCIF01.FPSC-000           | ✓   | ✓  | ✓  | ✓  | ✓  | ✓  |
|  | 5ACCIF01.FPSC-001           | ✓   | ✓  | ✓  | ✓  | ✓  | ✓  |
|  | 5ACCIF01.FSS0-000           | ✓   | ✓  | ✓  | ✓  | ✓  | ✓  |
|  | 5ACCIF01.ICAN-000           | ✓   | ✓  | ✓  | ✓  | ✓  | ✓  |
| 5ACCIF01.IS00-000  | ✓                           | ✓   | ✓  | ✓  | ✓  | ✓  |  |

#### 4.1.2.1.4 Determining the ambient temperature

1. Select the system unit.
2. The columns specify the maximum or minimum temperature in worst-case operation or the maximum temperature in typical operation of the complete system depending on the respective system unit.

#### **Information:**

**The maximum and typical temperature specifications correspond to a specification at 500 meters above sea level. The respective ambient temperature is derated approx. 1°C per 1000 meters starting at 500 m above sea level.**

3. If additional interface options and CFast cards are installed, these components can change the temperature limits of the PPC2100 system.
  - If a "✓" (check mark) is entered for the installed component, it can be operated without any problems.
  - If the installed component has a temperature specification (e.g. "45[°C]"), the ambient temperature of the complete system is not permitted to exceed this value.
4. Possible limitations may arise due to the mounting orientation of the Panel PC 2100. For additional information, see section "[Mounting orientations](#)" on page 28.
5. The relevant test and assessment must be carried out individually by the user on site (reading out the temperatures in BIOS or using the ADI Control Center). See section "[Information regarding typical conditions](#)" on page 37.

#### 4.1.2.1.5 Ambient temperature during storage and transport

The individual components can be transported and stored within the following temperature ranges.

##### AP9x3 panels

| Type               | Model number        | Storage [°C] | Transport [°C] |
|--------------------|---------------------|--------------|----------------|
| 12.1" single-touch | 5AP923.1215-00      | -25 to 80    | -25 to 80      |
| 15.0" single-touch | 5AP923.1505-00      | -25 to 80    | -25 to 80      |
| 19.0" single-touch | 5AP923.1906-00 ≤ D0 | -20 to 60    | -20 to 60      |
| 19.0" single-touch | 5AP923.1906-00 ≥ E0 | -25 to 70    | -25 to 70      |
| 15.6" multi-touch  | 5AP933.156B-00 ≤ C0 | -10 to 60    | -10 to 60      |
| 15.6" multi-touch  | 5AP933.156B-00 ≥ D0 | -25 to 70    | -25 to 70      |
| 18.5" multi-touch  | 5AP933.185B-00 ≤ C0 | -10 to 60    | -10 to 60      |
| 18.5" multi-touch  | 5AP933.185B-00 ≥ D0 | -20 to 60    | -20 to 60      |
| 21.5" multi-touch  | 5AP933.215C-00 ≤ C0 | -10 to 60    | -10 to 60      |
| 21.5" multi-touch  | 5AP933.215C-00 ≥ D0 | -20 to 60    | -20 to 60      |
| 24.0" multi-touch  | 5AP933.240C-00 ≤ C0 | -10 to 60    | -10 to 60      |
| 24.0" multi-touch  | 5AP933.240C-00 ≥ D0 | -25 to 70    | -25 to 70      |

##### AP1000 panels

| Type                         | Model number     | Storage [°C] | Transport [°C] |
|------------------------------|------------------|--------------|----------------|
| 5.7" single-touch            | 5AP1120.0573-000 | -25 to 80    | -25 to 80      |
| 5.7" keys                    | 5AP1151.0573-000 | -25 to 70    | -25 to 70      |
| 7.0" single-touch            | 5AP1120.0702-000 | -25 to 80    | -25 to 80      |
| 7.0" multi-touch             | 5AP1130.0702-000 | -25 to 70    | -25 to 70      |
| 10.1" multi-touch            | 5AP1130.101D-000 | -30 to 70    | -30 to 70      |
| 10.1" single-touch           | 5AP1120.101E-000 | -25 to 70    | -25 to 70      |
| 10.1" multi-touch            | 5AP1130.101E-000 | -25 to 70    | -25 to 70      |
| 10.4" single-touch           | 5AP1120.1043-000 | -25 to 80    | -25 to 80      |
| 10.4" single-touch with keys | 5AP1180.1043-000 | -25 to 70    | -25 to 70      |
| 10.4" single-touch with keys | 5AP1181.1043-000 | -25 to 70    | -25 to 70      |
| 10.4" single-touch with keys | 5AP1182.1043-000 | -25 to 70    | -25 to 70      |
| 12.1" single-touch           | 5AP1120.1214-000 | -25 to 80    | -25 to 80      |
| 12.1" single-touch           | 5AP1120.121E-000 | -25 to 80    | -25 to 80      |
| 12.1" multi-touch            | 5AP1130.121E-000 | -25 to 70    | -25 to 70      |
| 12.1" multi-touch            | 5AP1130.121E-010 | -30 to 70    | -30 to 70      |
| 15.0" single-touch           | 5AP1120.1505-000 | -25 to 80    | -25 to 80      |
| 15.0" single-touch with keys | 5AP1180.1505-000 | -25 to 70    | -25 to 70      |
| 15.0" single-touch with keys | 5AP1181.1505-000 | -25 to 70    | -25 to 70      |
| 15.6" single-touch           | 5AP1120.156B-000 | -25 to 70    | -25 to 70      |
| 15.6" multi-touch            | 5AP1130.156C-000 | -20 to 70    | -20 to 70      |
| 15.6" multi-touch            | 5AP1130.156C-001 | -20 to 70    | -20 to 70      |
| 18.5" multi-touch            | 5AP1130.185C-000 | -25 to 70    | -25 to 70      |
| 19.0" single-touch           | 5AP1120.1906-000 | -25 to 70    | -25 to 70      |

##### System units and components

| Component         | Model number             | Storage [°C] | Transport [°C] |
|-------------------|--------------------------|--------------|----------------|
| System units      | 5PPC2100.BYxx-000        | -20 to 60    | -20 to 60      |
| CFast cards       | 5CFAST.xxxx-00           | -50 to 100   | -50 to 100     |
|                   | 5CFAST.032G-10 ≥ Rev. G0 | -40 to 85    | -40 to 85      |
|                   | 5CFAST.064G-10 ≥ Rev. E0 | -40 to 85    | -40 to 85      |
|                   | 5CFAST.128G-10 ≥ Rev. E0 | -40 to 85    | -40 to 85      |
|                   | 5CFAST.032G-10 ≤ Rev. F0 | -55 to 95    | -55 to 95      |
|                   | 5CFAST.064G-10 ≤ Rev. D0 | -55 to 95    | -55 to 95      |
|                   | 5CFAST.128G-10 ≤ Rev. D0 | -55 to 95    | -55 to 95      |
|                   | 5CFAST.256G-10           | -40 to 85    | -40 to 85      |
| Interface options | 5ACCIF01.FPCC-000        | -20 to 60    | -20 to 60      |
|                   | 5ACCIF01.FPCS-000        | -20 to 60    | -20 to 60      |
|                   | 5ACCIF01.FPLK-000        | -20 to 60    | -20 to 60      |
|                   | 5ACCIF01.FPLS-000        | -20 to 60    | -20 to 60      |
|                   | 5ACCIF01.FPLS-001        | -20 to 60    | -20 to 60      |
|                   | 5ACCIF01.FPSC-000        | -20 to 60    | -20 to 60      |
|                   | 5ACCIF01.FPSC-001        | -20 to 60    | -20 to 60      |
|                   | 5ACCIF01.FSS0-000        | -20 to 60    | -20 to 60      |
|                   | 5ACCIF01.ICAN-000        | -20 to 60    | -20 to 60      |
|                   | 5ACCIF01.IS00-000        | -20 to 60    | -20 to 60      |

#### 4.1.2.1.6 Temperature monitoring

Sensors monitor temperature values at various areas in the PPC2100. For the position of temperature sensors, see section "[Temperature sensor positions](#)" on page 41. The values specified there represent the defined maximum temperature at this measuring point. If the temperature is exceeded, no alarm is triggered.

These temperatures <sup>2)</sup> can be read in various ways in approved operating systems:

- BIOS
- ADI Control Center
- ADI Development Kit
- ADI .NET SDK
- B&R HMI Service Center
- B&R HMI Report
- ADI OPC UA Server
- Automation Runtime library

The CFast cards available from B&R are equipped with S.M.A.R.T support<sup>3)</sup>. Various parameters (e.g. temperature) can be read out in approved Microsoft Windows or Linux for B&R operating systems.

<sup>2)</sup> The temperature measured approximates the immediate ambient temperature but may also be influenced by neighboring components.

<sup>3)</sup> Self-Monitoring, Analysis and Reporting Technology

4.1.2.1.7 Temperature sensor positions

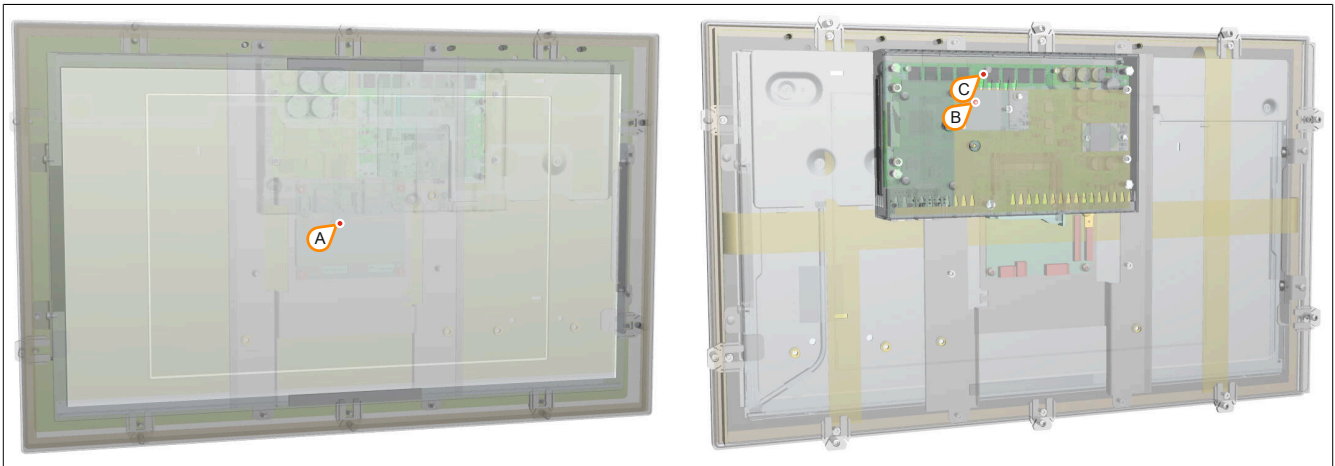

| ADI sensors          | Position | Measurement point for | Measurement  | Max. specified   |
|----------------------|----------|-----------------------|--|--|
| Panel                | A        | Display               | Temperature of the display (sensor integrated in panel).                 | 5AP923.1215-00: 90°C<br>5AP923.1505-00: 90°C<br>5AP923.1906-00 ≤ D0: 75°C<br>5AP923.1906-00 ≥ E0: 80°C<br>5AP933.156B-00 ≤ C0: 75°C<br>5AP933.156B-00 ≥ D0: 80°C<br>5AP933.185B-00: 75°C<br>5AP933.215C-00: 80°C<br>5AP933.240C-00 ≤ C0: 75°C<br>5AP933.240C-00 ≥ D0: 80°C<br>5AP1120.0573-000: 80°C<br>5AP1151.0573-000: 80°C<br>5AP1120.0702-000: 85°C<br>5AP1130.0702-000: 85°C<br>5AP1120.101E-000: 80°C<br>5AP1130.101D-000: 80°C<br>5AP1130.101E-000: 80°C<br>5AP1120.1043-000: 90°C<br>5AP1180.1043-000: 90°C<br>5AP1181.1043-000: 90°C<br>5AP1182.1043-000: 90°C<br>5AP1120.1214-000: 80°C<br>5AP1120.121E-000: 80°C<br>5AP1130.121E-000: 80°C<br>5AP1130.121E-010: 80°C<br>5AP1120.1505-000: 90°C<br>5AP1180.1505-000: 90°C<br>5AP1120.156B-000: 80°C<br>5AP1130.156C-000: 80°C<br>5AP1130.156C-001: 80°C<br>5AP1130.185C-000: 80°C<br>5AP1120.1906-000: 80°C<br>5AP1181.1505-000: 90°C |
| System unit sensor 2 | B        | CPU                   | Temperature of the processor area (sensor integrated on the CPU board)   | 95°C   |
| System unit sensor 1 | C        | Main memory           | Temperature of the main memory area (sensor integrated on the CPU board) | 95°C   |

### 4.1.2.2 Humidity

The following tables show the minimum and maximum relative humidity (at 30°C, non-condensing) of the individual components that are relevant for limiting the humidity of the complete system. The smallest or largest value must always be used for this determination. For more detailed information, see technical data or temperature/humidity diagrams of the individual components.

#### AP9x3 panels

| Type               | Model number        | Operation [%] | Storage [%] | Transport [%] |
|--------------------|---------------------|---------------|-------------|---------------|
| 12.1" single-touch | 5AP923.1215-00      | 5 to 90       | 5 to 90     | 5 to 90       |
| 15.0" single-touch | 5AP923.1505-00      | 8 to 90       | 8 to 90     | 8 to 90       |
| 19.0" single-touch | 5AP923.1906-00      | 5 to 90       | 5 to 90     | 5 to 90       |
| 15.6" multi-touch  | 5AP933.156B-00      | 5 to 90       | 5 to 90     | 5 to 90       |
| 18.5" multi-touch  | 5AP933.185B-00      | 5 to 90       | 5 to 90     | 5 to 90       |
| 21.5" multi-touch  | 5AP933.215C-00 ≤ C0 | 10 to 90      | 10 to 90    | 10 to 90      |
| 21.5" multi-touch  | 5AP933.215C-00 ≥ D0 | 5 to 90       | 5 to 90     | 5 to 90       |
| 24.0" multi-touch  | 5AP933.240C-00      | 5 to 90       | 5 to 90     | 5 to 90       |

#### AP1000 panels

| Type                         | Model number               | Operation [%] | Storage [%] | Transport [%] |
|------------------------------|----------------------------|---------------|-------------|---------------|
| 5.7" single-touch            | 5AP1120.0573-000 ≤ Rev. D0 | 5 to 90       | 5 to 90     | 5 to 90       |
| 5.7" single-touch            | 5AP1120.0573-000 ≥ Rev. E0 | 20 to 90      | 10 to 90    | 10 to 90      |
| 5.7" keys                    | 5AP1151.0573-000 ≤ Rev. D0 | 5 to 90       | 5 to 90     | 5 to 90       |
| 5.7" keys                    | 5AP1151.0573-000 ≥ Rev. E0 | 20 to 90      | 10 to 90    | 10 to 90      |
| 7.0" single-touch            | 5AP1120.0702-000           | 20 to 90      | 10 to 90    | 10 to 90      |
| 7.0" multi-touch             | 5AP1130.0702-000           | 20 to 90      | 10 to 90    | 10 to 90      |
| 10.1" single-touch           | 5AP1120.101E-000           | 20 to 90      | 10 to 90    | 10 to 90      |
| 10.1" multi-touch            | 5AP1130.101D-000           | 5 to 85       | 5 to 85     | 5 to 85       |
| 10.1" multi-touch            | 5AP1130.101E-000           | 20 to 90      | 10 to 90    | 10 to 90      |
| 10.4" single-touch           | 5AP1120.1043-000           | 5 to 90       | 5 to 90     | 5 to 90       |
| 10.4" single-touch with keys | 5AP1180.1043-000           | 5 to 80       | 5 to 90     | 5 to 90       |
| 10.4" single-touch with keys | 5AP1181.1043-000           | 5 to 80       | 5 to 90     | 5 to 90       |
| 10.4" single-touch with keys | 5AP1182.1043-000           | 5 to 80       | 5 to 90     | 5 to 90       |
| 12.1" single-touch           | 5AP1120.1214-000           | 20 to 90      | 10 to 90    | 10 to 90      |
| 12.1" single-touch           | 5AP1120.121E-000           | 5 to 90       | 5 to 90     | 5 to 90       |
| 12.1" multi-touch            | 5AP1130.121E-000           | 5 to 90       | 5 to 90     | 5 to 90       |
| 12.1" multi-touch            | 5AP1130.121E-010           | 5 to 90       | 5 to 90     | 5 to 90       |
| 15.0" single-touch           | 5AP1120.1505-000           | 8 to 90       | 8 to 90     | 8 to 90       |
| 15.0" single-touch with keys | 5AP1180.1505-000           | 8 to 90       | 8 to 90     | 8 to 90       |
| 15.0" single-touch with keys | 5AP1181.1505-000           | 8 to 90       | 8 to 90     | 8 to 90       |
| 15.6" single-touch           | 5AP1120.156B-000           | 5 to 90       | 5 to 90     | 5 to 90       |
| 15.6" multi-touch            | 5AP1130.156C-000           | 5 to 90       | 5 to 90     | 5 to 90       |
| 15.6" multi-touch            | 5AP1130.156C-001           | 5 to 90       | 5 to 90     | 5 to 90       |
| 18.5" multi-touch            | 5AP1130.185C-000           | 5 to 90       | 5 to 90     | 5 to 90       |
| 19.0" single-touch           | 5AP1120.1906-000           | 5 to 90       | 5 to 90     | 5 to 90       |

#### System units and components

| Component         | Order number             | Operation [%]    | Storage [%]      | Transport [%]    |
|-------------------|--------------------------|------------------|------------------|------------------|
| System units      | 5PPC2100.BYxx-000        | 5 to 90          | 5 to 95          | 5 to 95          |
| CFast cards       | 5CFAST.xxxx-00           | Max. 85% at 85°C | Max. 85% at 85°C | Max. 85% at 85°C |
|                   | 5CFAST.032G-10 ≥ Rev. G0 | Max. 85% at 85°C | Max. 85% at 85°C | Max. 85% at 85°C |
|                   | 5CFAST.064G-10 ≥ Rev. E0 | Max. 85% at 85°C | Max. 85% at 85°C | Max. 85% at 85°C |
|                   | 5CFAST.128G-10 ≥ Rev. E0 | Max. 85% at 85°C | Max. 85% at 85°C | Max. 85% at 85°C |
|                   | 5CFAST.032G-10 ≤ Rev. F0 | 10 to 95         | 10 to 95         | 10 to 95         |
|                   | 5CFAST.064G-10 ≤ Rev. D0 | 10 to 95         | 10 to 95         | 10 to 95         |
|                   | 5CFAST.128G-10 ≤ Rev. D0 | 10 to 95         | 10 to 95         | 10 to 95         |
|                   | 5CFAST.256G-10           | Max. 85% at 85°C | Max. 85% at 85°C | Max. 85% at 85°C |
| Interface options | 5ACCIF01.FPCC-000        | 5 to 90          | 5 to 95          | 5 to 95          |
|                   | 5ACCIF01.FPCS-000        | 5 to 90          | 5 to 95          | 5 to 95          |
|                   | 5ACCIF01.FPLK-000        | 5 to 90          | 5 to 95          | 5 to 95          |
|                   | 5ACCIF01.FPLS-000        | 5 to 90          | 5 to 95          | 5 to 95          |
|                   | 5ACCIF01.FPLS-001        | 5 to 90          | 5 to 95          | 5 to 95          |
|                   | 5ACCIF01.FPSC-000        | 5 to 90          | 5 to 95          | 5 to 95          |
|                   | 5ACCIF01.FPSC-001        | 5 to 90          | 5 to 95          | 5 to 95          |
|                   | 5ACCIF01.FSS0-000        | 5 to 90          | 5 to 95          | 5 to 95          |
|                   | 5ACCIF01.ICAN-000        | 5 to 90          | 5 to 95          | 5 to 95          |
| 5ACCIF01.IS00-000 | 5 to 90                  | 5 to 95          | 5 to 95          |                  |

### 4.1.2.3 Vibration

The following table provides an overview of the maximum vibration values of the complete system. Limitations are possible due to individual components.

| Panel PC        | Operation <sup>1)</sup>                               |  | Storage <sup>1)2)</sup>   | Transport <sup>1)2)</sup>   |
|-----------------|---|--|---|---|
|                 | Continuous  | Periodic   |   |   |
| With CFast card | 2 to 9 Hz:<br>1.75 mm amplitude<br>9 to 200 Hz: 0.5 g | 2 to 9 Hz:<br>3.5 mm amplitude<br>9 to 200 Hz: 1 g | 2 to 8 Hz: 7.5 mm amplitude<br>8 to 200 Hz: 2 g<br>200 to 500 Hz: 4 g | 2 to 8 Hz: 7.5 mm amplitude<br>8 to 200 Hz: 2 g<br>200 to 500 Hz: 4 g |

1) Testing is performed in accordance with EN 60068-2-6.

2) This value applies to a device in its original packaging.

### 4.1.2.4 Shock

The following table provides an overview of the maximum shock values of the complete system. Limitations are possible due to individual components.

| Panel PC        | Operation <sup>1)</sup> | Storage <sup>1)2)</sup> | Transport <sup>1)2)</sup> |
|-----------------|-------------------------|-------------------------|---------------------------|
| With CFast card | 15 g, 11 ms             | 30 g, 6 ms              | 30 g, 6 ms                |

1) Testing is performed in accordance with EN 60068-2-27.

2) This value applies to a device in its original packaging.

### 4.1.2.5 Degree of protection

Under the following conditions, the Panel PC 2100 offers IP65 protection on the front and IP20 protection on the back per EN 60529:

- Correct installation of the Panel PC 2100 (see ["Installation and wiring" on page 169](#))
- Installation of all covers or components on interfaces and slots
- Compliance with all ambient conditions

The Panel PC 2100 with AP9x3 and AP1000 panels additionally has "Type 4X indoor use only" on the front per UL 50 under the same conditions.

### 4.1.3 Electrical properties

#### 4.1.3.1 System units - Block diagram

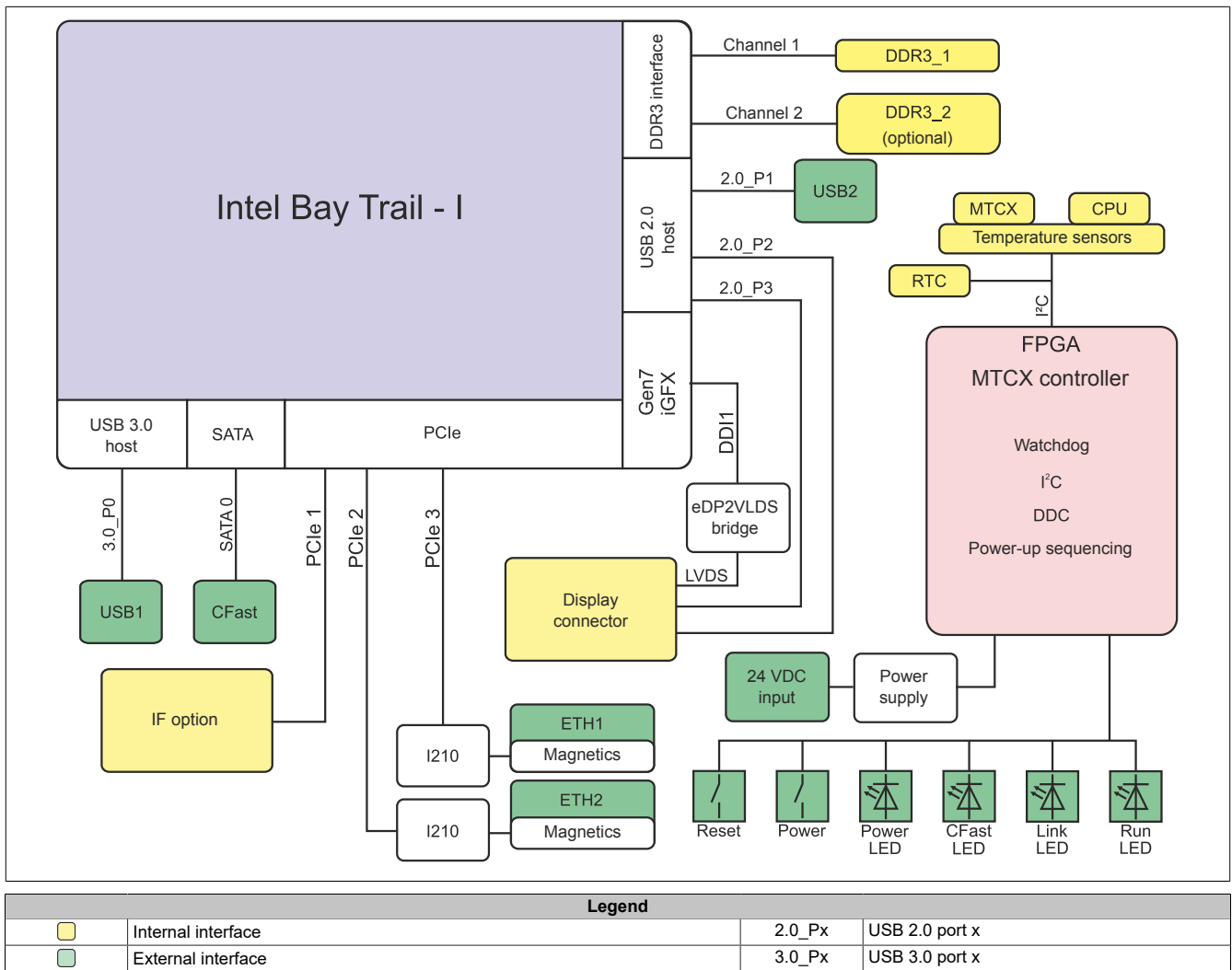

### 4.1.3.2 Power calculation

In order to calculate the total power of the Panel PC 2100, the power rating of the display used (see or ) must be added to the power rating of the system unit; if an interface option or optional CFast card is connected, these power ratings must be added as well.

#### System units

| Type                      | Model number      | Total power consumption                                 |
|---------------------------|-------------------|---|
| PPC2100 E3815 1C 1.46 GHz | 5PPC2100.BY01-000 | 12 W (without USB consumer)<br>22 W (with USB consumer) |
| PPC2100 E3825 2C 1.33 GHz | 5PPC2100.BY11-000 | 13 W (without USB consumer)<br>23 W (with USB consumer) |
| PPC2100 E3826 2C 1.46 GHz | 5PPC2100.BY22-000 | 15 W (without USB consumer)<br>25 W (with USB consumer) |
| PPC2100 E3827 2C 1.75 GHz | 5PPC2100.BY34-000 | 17 W (without USB consumer)<br>27 W (with USB consumer) |
| PPC2100 E3845 4C 1.91 GHz | 5PPC2100.BY44-000 | 19 W (without USB consumer)<br>29 W (with USB consumer) |
| PPC2100 E3845 4C 1.91 GHz | 5PPC2100.BY48-000 | 20 W (without USB consumer)<br>30 W (with USB consumer) |

#### AP9x3 panels

| Type               | Order number        | +5 V   | +3.3 V | +12 V  | Total power consumption |
|--------------------|---------------------|--------|--------|--------|-------------------------|
| 12.1" single-touch | 5AP923.1215-00      | -      | 4.2 W  | 7.2 W  | 11.4 W                  |
| 15.0" single-touch | 5AP923.1505-00      | -      | 2.1 W  | 8.9 W  | 11 W                    |
| 19.0" single-touch | 5AP923.1906-00 ≤ D0 | 8 W    | -      | 22.4 W | 30.4 W                  |
| 19.0" single-touch | 5AP923.1906-00 ≥ E0 | 5 W    | -      | 22 W   | 27 W                    |
| 15.6" multi-touch  | 5AP933.156B-00 ≤ C0 | 3.35 W | -      | 10.5 W | 13.85 W                 |
| 15.6" multi-touch  | 5AP933.156B-00 ≥ D0 | 1.8 W  | -      | 15.6 W | 17.4 W                  |
| 18.5" multi-touch  | 5AP933.185B-00      | 6.1 W  | -      | 10.8 W | 16.9 W                  |
| 21.5" multi-touch  | 5AP933.215C-00 ≤ C0 | 7.4 W  | -      | 18.3 W | 25.7 W                  |
| 21.5" multi-touch  | 5AP933.215C-00 ≥ D0 | 4 W    | -      | 15 W   | 19 W                    |
| 24.0" multi-touch  | 5AP933.240C-00 ≤ C0 | 6.35 W | -      | 24 W   | 30.35 W                 |
| 24.0" multi-touch  | 5AP933.240C-00      | 5 W    | -      | 24.5 W | 29.5 W                  |

#### AP1000 panels

| Type                         | Order number   | +5 V  | +3.3 V | +12 V  | Total power consumption |
|------------------------------|--|-------|--------|--------|-------------------------|
| 5.7" single-touch            | 5AP1120.0573-000                                     | -     | 0.7 W  | 2.5 W  | 3.2 W                   |
| 5.7" keys                    | 5AP1151.0573-000                                     | 0.5 W | 1.3 W  | 2.5 W  | 4.3 W                   |
| 7.0" single-touch            | 5AP1120.0702-000                                     | -     | 1.0 W  | 3.5 W  | 4.5 W                   |
| 7.0" multi-touch             | 5AP1130.0702-000                                     | 1.0 W | 1.0 W  | 3.5 W  | 5.5 W                   |
| 10.1" single-touch           | 5AP1120.101E-000                                     | -     | 1.1 W  | 7.1 W  | 8.2 W                   |
| 10.1" single-touch           | 5AP1120.101E-000<br>(hardware revision F0 and later) | -     | 1.0 W  | 5.8 W  | 6.8 W                   |
| 10.1" multi-touch            | 5AP1130.101D-000                                     | 1.0 W | 2.2 W  | 7.5 W  | 10.7 W                  |
| 10.1" multi-touch            | 5AP1130.101E-000                                     | 1.0 W | 1.1 W  | 7.1 W  | 9.2 W                   |
| 10.4" single-touch           | 5AP1120.1043-000                                     | -     | 1.3 W  | 3.6 W  | 4.9 W                   |
| 10.4" single-touch with keys | 5AP1180.1043-000                                     | 0.5 W | 1.9 W  | 3.6 W  | 6.0 W                   |
| 10.4" single-touch with keys | 5AP1181.1043-000                                     | 0.7 W | 1.9 W  | 3.6 W  | 6.2 W                   |
| 10.4" single-touch with keys | 5AP1182.1043-000                                     | 1.0 W | 1.9 W  | 3.6 W  | 6.5 W                   |
| 12.1" single-touch           | 5AP1120.1214-000                                     | -     | 1.9 W  | 7.0 W  | 8.9 W                   |
| 12.1" single-touch           | 5AP1120.121E-000                                     | -     | 2.5 W  | 7.8 W  | 10.3 W                  |
| 12.1" multi-touch            | 5AP1130.121E-000                                     | 1.0 W | 2.5 W  | 7.8 W  | 11.3 W                  |
| 12.1" multi-touch            | 5AP1130.121E-010                                     | 1.0 W | 1.9 W  | 10.7 W | 13.6 W                  |
| 15.0" single-touch           | 5AP1120.1505-000                                     | -     | 2.1 W  | 8.9 W  | 11.0 W                  |
| 15.0" single-touch with keys | 5AP1180.1505-000                                     | 0.5 W | 2.7 W  | 8.9 W  | 12.1 W                  |
| 15.0" single-touch with keys | 5AP1181.1505-000                                     | 0.8 W | 2.7 W  | 8.9 W  | 12.4 W                  |
| 15.6" single-touch           | 5AP1120.156B-000                                     | 1.8 W | -      | 15.6 W | 17.4 W                  |
| 15.6" multi-touch            | 5AP1130.156C-000                                     | 6 W   | -      | 18 W   | 24 W                    |
| 15.6" multi-touch            | 5AP1130.156C-001                                     | 6 W   | -      | 18 W   | 24 W                    |
| 18.5" multi-touch            | 5AP1130.185C-000                                     | 7 W   | -      | 18.6 W | 25.6 W                  |
| 19.0" single-touch           | 5AP1120.1906-000                                     | 5.0 W | -      | 22.0 W | 27.0 W                  |

#### Interface options

| Type                | Order number      | +5 V   | +3.3 V | +12 V | Total power consumption |
|---------------------|-------------------|--------|--------|-------|-------------------------|
| POWERLINK CAN X2X   | 5ACCIF01.FPCC-000 | 0.45 W | 1.55 W | -     | 2.00 W                  |
| POWERLINK RS485 CAN | 5ACCIF01.FPCS-000 | 0.75 W | 1.00 W | -     | 1.75 W                  |
| POWERLINK           | 5ACCIF01.FPLK-000 | -      | 1.75 W | -     | 1.75 W                  |
| POWERLINK RS232     | 5ACCIF01.FPLS-000 | 0.50 W | 1.00 W | -     | 1.50 W                  |
| POWERLINK RS232     | 5ACCIF01.FPLS-001 | -      | 1.50 W | -     | 1.50 W                  |

## Technical data

| Type                    | Order number      | +5 V   | +3.3 V | +12 V | Total power consumption |
|-------------------------|-------------------|--------|--------|-------|-------------------------|
| POWERLINK RS232 CAN     | 5ACCIF01.FPSC-000 | 0.75 W | 1.00 W | -     | 1.75 W                  |
| POWERLINK RS232 CAN X2X | 5ACCIF01.FPSC-001 | 0.60 W | 1.40 W | -     | 2.00 W                  |
| 2x RS422/RS485          | 5ACCIF01.FSS0-000 | 0.80 W | 0.20 W | -     | 1.00 W                  |
| CAN                     | 5ACCIF01.ICAN-000 | 0.45 W | 0.05 W | -     | 0.50 W                  |
| RS232                   | 5ACCIF01.IS00-000 | -      | 0.50 W | -     | 0.50 W                  |

## CFast cards

| Type           | Order number  | +5 V | +3.3 V                                   | +12 V | Total power consumption                  |
|----------------|---|------|--|-------|--|
| SLC technology | 5CFAST.xxxx-00  | -    | 0.7 W read<br>0.7 W write<br>0.3 W idle  | -     | 0.7 W read<br>0.7 W write<br>0.3 W idle  |
| MLC technology | 5CFAST.032G-10 ≥ G0<br>5CFAST.064G-10 ≥ E0                        | -    | 1.1 W read<br>1 W write<br>0.25 W idle   | -     | 1.1 W read<br>1 W write<br>0.25 W idle   |
|                | 5CFAST.128G-10 ≥ E0   | -    | 1.1 W read<br>1.4 W write<br>0.25 W idle | -     | 1 W read<br>1.4 W write<br>0.25 W idle   |
|                | 5CFAST.032G-10 ≤ F0<br>5CFAST.064G-10 ≤ D0<br>5CFAST.128G-10 ≤ D0 | -    | 0.8 W read<br>1 W write<br>0.4 W idle    | -     | 0.8 W read<br>1 W write<br>0.4 W idle    |
|                | 5CFAST.256G-10  | -    | 1.2 W read<br>1.9 W write<br>0.25 W idle | -     | 1.2 W read<br>1.9 W write<br>0.25 W idle |

## Example

|                                |                          |               |
|--------------------------------|--------------------------|---------------|
| 12" panel 5AP923.1215-00       | 4.2 W + 7.2 W =          | 11.4 W        |
| 5PPC2100.BY11-000 system unit  | 23 W (with USB consumer) | 23 W          |
| CFast card 5CFAST.064G-10 ≥ E0 |                          | 1.1 W         |
| <b>Total max.:</b>             |                          | <b>35.5 W</b> |

## 4.1.4 Device interfaces and slots

### 4.1.4.1 Device interfaces - Overview

#### Information:

The interfaces available on the device or module are numbered for the purpose of clear differentiation. The numbering used by the operating system may deviate, however.

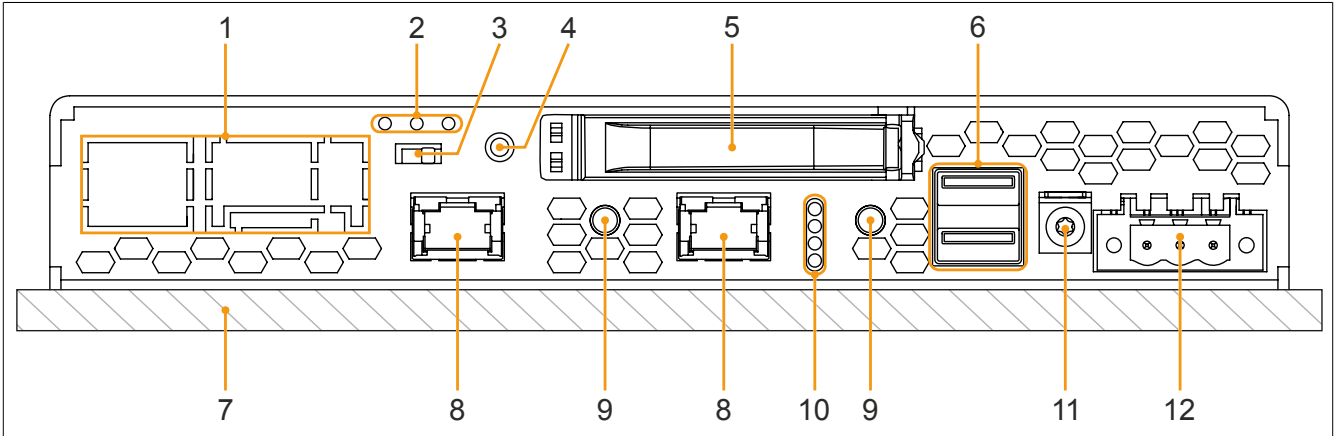

| Legend |   |    |                                      |
|--------|---|----|--------------------------------------|
| 1      | "IF option slot(IF1, IFx)" on page 53           | 7  | Panel (configuration-dependent)      |
| 2      | IF option - LED status indicators <sup>1)</sup> | 8  | "Ethernet interfaces" on page 49     |
| 3      | IF option - Terminating resistor <sup>1)</sup>  | 9  | "Power and reset buttons" on page 51 |
| 4      | Screw point for cable shield                    | 10 | "LED status indicators" on page 52   |
| 5      | "CFast slot" on page 51                         | 11 | "Grounding" on page 48               |
| 6      | "USB interfaces" on page 50                     | 12 | " +24 VDC power supply" on page 48   |

1) Only available with installed interface option (configuration-dependent, see "Interface options" on page 132).

### 4.1.4.2 +24 VDC power supply

## Danger!

This device is only permitted to be supplied with a SELV/PELV power supply unit or with safety extra-low voltage (SELV) per IEC 61010-2-201.

The necessary 3-pin connector is not included in delivery; for suitable accessories, see "0TB103.9x" on page 267.

The device is protected against overload and reverse polarity by a soldered fuse (10 A, fast-acting). If the fuse is defective (e.g. due to overload), the device must be sent to B&R for repairs. If the polarity is reversed, it is not necessary to replace the fuse.

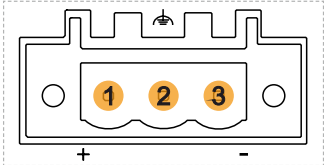
| Pin  | Description                      | Figure  |
|--|----------------------------------|---|
| 1  | +                                |  |
| 2  | Functional ground                |   |
| 3  | -                                |   |
| <ul style="list-style-type: none"> <li>Reverse polarity protection</li> <li>3-pin</li> <li>Male</li> </ul> |                                  |   |
| Electrical properties  |                                  |   |
| Nominal voltage  | 24 VDC ±25%, SELV <sup>1)</sup>  |   |
| Nominal current  | Max. 3.5 A                       |   |
| Overvoltage category per EN 61131-2  | II                               |   |
| Inrush current   | Typ. 6 A, max. 10 A for < 300 µs |   |
| Galvanic isolation   | Yes                              |   |
| Uninterruptible power supply   | No                               |   |

1) IEC 61010-2-201 requirements must be observed.

### 4.1.4.2.1 Grounding

## Caution!

The functional ground (power supply pin 2 and ground connection) must be connected to the central grounding point (e.g. control cabinet or system) via the shortest possible path with the lowest possible resistance and with the largest possible wire cross section. This type of grounding is mandatory for proper functionality.

For example, a copper strip must be attached to the ground connection at a central grounding point of the control cabinet or system in which the device is installed. The wire cross section should be as large as possible (at least 2.5 mm<sup>2</sup>).

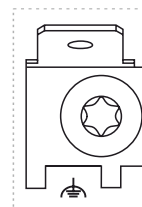

### 4.1.4.3 Ethernet interfaces

The Ethernet controller is routed externally via the system unit.

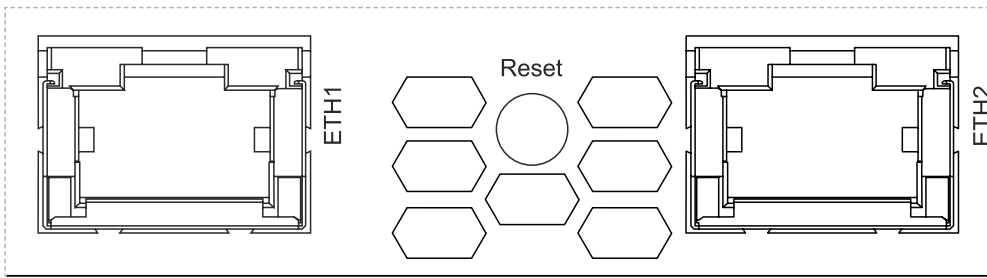

| ETH1, ETH2             |   |                                   |
|------------------------|---|-----------------------------------|
| Variant                | RJ45, female                                      |                                   |
| Controller             | Intel I210  |                                   |
| Wiring                 | S/STP (Cat 5e)                                    |                                   |
| Transfer rate          | 10/100/1000 Mbit/s <sup>1)</sup>                  |                                   |
| Cable length           | Max. 100 m (min. Cat 5e)                          |                                   |
| <b>LED "Speed" (b)</b> | <b>On</b>   | <b>Off</b>                        |
| Yellow                 | 100 Mbit/s  | 10 Mbit/s <sup>2)</sup>           |
| Green                  | 1000 Mbit/s                                       | -                                 |
| <b>LED "Link" (a)</b>  | <b>On</b>   | <b>Active</b>                     |
| Green                  | Link (a connection to an Ethernet network exists) | Blinking (data being transferred) |

The diagram shows a close-up of the RJ45 port. The port is labeled '1' at the top. Below the port, there are two LED indicators labeled 'a' and 'b'.

- 1) Switching takes place automatically.
- 2) The 10 Mbit/s transfer rate / connection is only available if LED "Link" is active at the same time.

#### Driver support

A special driver is required to operate the Ethernet controller. Drivers for approved operating systems are available for download in the Downloads section of the B&R website ([www.br-automation.com](http://www.br-automation.com)).

#### Information:

**Necessary drivers must be downloaded from the B&R website, not from manufacturer websites.**

#### 4.1.4.4 USB interfaces

The Panel PC is equipped with a Universal Serial Bus 3.0 (USB 3.0) host controller with several USB ports, of which one USB 3.0 interface and one USB 2.0 interface are routed externally and freely available to the user.

### Warning!

USB peripheral devices can be connected to the USB interfaces. Due to the variety of USB devices available on the market, B&R cannot guarantee their functionality. The functionality of USB devices available from B&R is ensured.

### Caution!

Due to the general PC specification, this interface must be handled with the utmost care with regard to EMC, cable routing, etc.

#### Driver support

A special driver is necessary to operate the USB 3.0 host controller with multiple USB ports. Drivers for approved operating systems are available for download in the Downloads section of the B&R website ([www.br-automation.com](http://www.br-automation.com)).

### Information:

Necessary drivers must be downloaded from the B&R website, not from manufacturer websites.

| USB1 and USB2                           |                                     |                                      |
|---|-------------------------------------|--------------------------------------|
| Standard                                | USB1                                | USB 3.0                              |
|   | USB2                                | USB 2.0                              |
| Variant                                 | Type A, female                      |                                      |
| Transfer rate                           | Low speed (1.5 Mbit/s)              |                                      |
|   | Full speed (12 Mbit/s)              |                                      |
|   | High speed (480 Mbit/s)             |                                      |
|   | SuperSpeed (5 Gbit/s) <sup>1)</sup> |                                      |
| Current-carrying capacity <sup>2)</sup> | Max. 1 A per connection             |                                      |
| Cable length                            | USB 2.0                             | Max. 5 m (without hub) <sup>3)</sup> |
|   | USB 3.0                             | Max. 3 m (without hub)               |

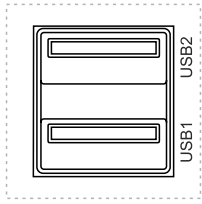

- 1) Compatibility with SuperSpeed depends on the operating system used and is only possible with USB 3.0.
- 2) Each USB interface is protected by a maintenance-free "USB current-limiting switch" (max. 1 A).
- 3) With revisions < B0 for system units, the max. cable length has been specified at 3 m.

#### Front USB interface panel

Automation Panel 1000 devices with 10.4", 12.1" (4:3 format only), 15" (4:3 format only) and 19" diagonals are equipped with a front USB 2.0 interface. For additional information, see section "USB interfaces" in chapter "Device interfaces and slots" on page 47.

#### USB hub interfaces

4-port USB hub 5ACCUSB4.0000-000 provides up to 4 additional USB interfaces for the Panel PC 2100. For additional information, see section "USB hub" on page 270.

#### 4.1.4.5 CFast slot

The Panel PC offers an easy-to-access CFast slot so that a CFast card can also be used as a removable storage medium for transferring data or performing upgrades.

This CFast slot is internally connected to the chipset and implemented in version SATA II (SATA 3.0 Gbit/s).

### Information:

**5CFAST.0xxx-00 CFast cards are only permitted to be operated in the xPC2100 with revision E0 or later.**

| CFast slot     |                   |
|----------------|-------------------|
| Connection     | SATA 0            |
| Order number   | Short description |
| CFast cards    |                   |
| 5CFAST.2048-00 | CFast 2 GB SLC    |
| 5CFAST.4096-00 | CFast 4 GB SLC    |
| 5CFAST.8192-00 | CFast 8 GB SLC    |
| 5CFAST.016G-00 | CFast 16 GB SLC   |
| 5CFAST.032G-00 | CFast 32 GB SLC   |
| 5CFAST.032G-10 | CFast 32 GB MLC   |
| 5CFAST.064G-10 | CFast 64 GB MLC   |
| 5CFAST.128G-10 | CFast 128 GB MLC  |
| 5CFAST.256G-10 | CFast 256 GB MLC  |

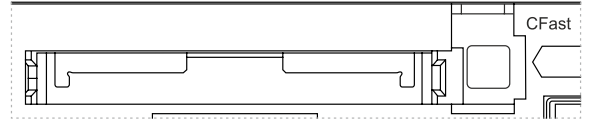

### Warning!

**CFast cards are only permitted to be inserted and removed in a voltage-free state!**

#### 4.1.4.6 Power and reset buttons



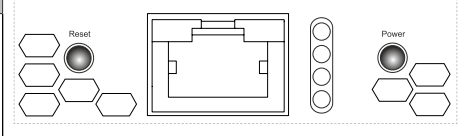





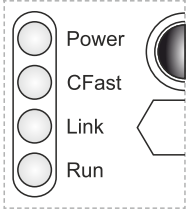

Both buttons can be pressed without any tools.

| Description  |  |
|--|--|
| <p><b>Power button</b></p> <p>The power button offers full ATX power supply support and has various configurable functions.</p> <ul style="list-style-type: none"> <li>• <b>Short press:</b> Switches the PC on or off or performs the action configured in the operating system when pressing the power button (shutdown, sleep, etc.).</li> <li>• <b>Long press (approx. 4 s):</b> The ATX power supply switches off the PC without shutting it down.</li> </ul> <p>Pressing the power button does not reset the MTCX processor.</p> |  |
| <p><b>Reset button</b></p> <p>Pressing the reset button triggers a hardware/PCI reset. The PC is restarted. During a reset, the MTCX processor is not reset.</p>   |  |

### Warning!

**Switching off the power without shutting down or resetting the system can result in data loss!**

### 4.1.4.7 LED status indicators

| Assignment  | LED   | Color     | Status                            | Explanation   | LED status indicators <sup>1)</sup>   |  |
|---|---|-----------|-----------------------------------|---|---|--|
|  | Power   | Green     | On                                | Power supply OK   |  |  |
|   |   | Red       | On                                | The system is in power saving mode (standby). <sup>1)</sup>                             |  |  |
|   |   | Red-Green | Blinking                          | Faulty or incomplete BIOS, MTCX or I/O FPGA update, power supply OK                     |  |  |
|   |   |           |                                   | Faulty or incomplete BIOS, MTCX or I/O FPGA update, power saving mode (standby)         |  |  |
|   | <p><b>Information:</b><br/>An update must be performed again.</p> |           |                                   |   |   |  |
|   | CFast   | Yellow    | On                                | Indicates CFast access  |  |  |
|   | Link  | Reserved  |                                   |   |   |  |
|   | Run   | Green     | Blinking                          | Automation Runtime is starting up. Controlled by Automation Runtime (ARemb and AR-win). |  |  |
|   |   | Green     | On                                | Application running Controlled by Automation Runtime (ARemb and AR-win).                |  |  |
|   |   | Red       | On                                | Application in SERVICE mode Controlled by Automation Runtime (ARemb and AR-win).        |  |  |
| Orange  |   | Blinking  | A license violation has occurred. |      |   |  |

- 1) Two columns form 1 interval of 500 ms each.
- 2) S5: Soft-off  
S4: Hibernate (suspend-to-disk)

#### 4.1.4.8 IF option slot(IF1, IFx)

Panel PC system units have 1 slot for an interface option.

The following table lists the interface options that can be operated in the IF option slot.

| IF option IF1, IFx slot |   |
|-------------------------|---|
| Model number            | Interface option - Short description  |
| 5ACCIF01.FPCC-000       | Interface card - 2x CAN interfaces - 1x X2X Link interface - 1x POWERLINK interface - 512 kB nvSRAM - For APC2100/PPC2100 and APC2200/PPC2200                     |
| 5ACCIF01.FPCS-000       | Interface card - 1x RS485 interface - 1x CAN interface - 1x POWERLINK interface - 32 kB FRAM - For APC2100/PPC2100 and APC2200/PPC2200                            |
| 5ACCIF01.FPLK-000       | Interface card - 2x POWERLINK interfaces - 512 kB nvSRAM - For APC2100/PPC2100 and APC2200/PPC2200  |
| 5ACCIF01.FPLS-000       | Interface card - 1x RS232 interface - 1x POWERLINK interface - 32 kB FRAM - For APC2100/PPC2100 and APC2200/PPC2200   |
| 5ACCIF01.FPLS-001       | Interface card - 1x RS232 interface - 1x POWERLINK interface - 512 kB nvSRAM - For APC2100/PPC2100 and APC2200/PPC2200  |
| 5ACCIF01.FPSC-000       | Interface card - 1x RS232 interface - 1x CAN interface - 1x POWERLINK interface - 32 kB FRAM - For APC2100/PPC2100 and APC2200/PPC2200                            |
| 5ACCIF01.FPSC-001       | Interface card - 1x RS232 interface - 1x CAN interface - 1x X2X Link interface - 1x POWERLINK interface - 512 kB nvSRAM - For APC2100/PPC2100 and APC2200/PPC2200 |
| 5ACCIF01.FSS0-000       | Interface card - 2x RS422/RS485 interface - For APC2100/PPC2100 and APC2200/PPC2200   |
| 5ACCIF01.ICAN-000       | Interface card - 1x CAN interface - For APC2100/PPC2100 and APC2200/PPC2200   |
| 5ACCIF01.IS00-000       | Interface card - 1x RS232 interface - For APC2100/PPC2100/APC2200/PPC2200   |

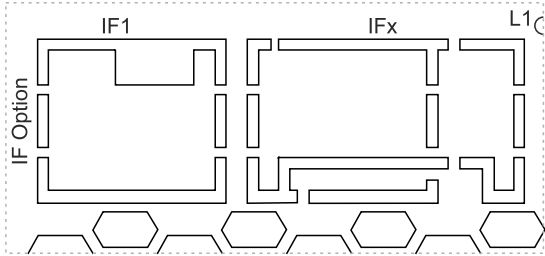

### Information:

Interface options can only be installed and replaced at the B&R factory.

### 4.1.5 Features of AP1000 panels

Different display diagonals as well as panels with touch screen and keys are available. The following table provides an overview of the panels and their features. For examples of different equipment variants, see the figure below.

| Display type                 | Order number     | Resolution | Touch screen | Function keys | System keys | Front USB interface |
|------------------------------|------------------|------------|--------------|---------------|-------------|---------------------|
| 5.7" single-touch            | 5AP1120.0573-000 | VGA        | Single-touch | No            | No          | No                  |
| 5.7" keys                    | 5AP1151.0573-000 | VGA        | No           | Yes           | Yes         | No                  |
| 7.0" single-touch            | 5AP1120.0702-000 | WVGA       | Single-touch | No            | No          | No                  |
| 7.0" multi-touch             | 5AP1130.0702-000 | WVGA       | Multi-touch  | No            | No          | No                  |
| 10.1" single-touch           | 5AP1120.101E-000 | WXGA       | Single-touch | No            | No          | No                  |
| 10.1" multi-touch            | 5AP1130.101D-000 | WUXGA      | Multi-touch  | No            | No          | No                  |
| 10.1" multi-touch            | 5AP1130.101E-000 | WXGA       | Multi-touch  | No            | No          | No                  |
| 10.4" single-touch           | 5AP1120.1043-000 | VGA        | Single-touch | No            | No          | Yes                 |
| 10.4" single-touch with keys | 5AP1180.1043-000 | VGA        | Single-touch | Yes           | No          | Yes                 |
| 10.4" single-touch with keys | 5AP1181.1043-000 | VGA        | Single-touch | Yes           | Yes         | Yes                 |
| 10.4" single-touch with keys | 5AP1182.1043-000 | VGA        | Single-touch | Yes           | Yes         | Yes                 |
| 12.1" single-touch           | 5AP1120.1214-000 | SVGA       | Single-touch | No            | No          | Yes                 |
| 12.1" single-touch           | 5AP1120.121E-000 | WXGA       | Single-touch | No            | No          | No                  |
| 12.1" multi-touch            | 5AP1130.121E-000 | WXGA       | Multi-touch  | No            | No          | No                  |
| 12.1" multi-touch            | 5AP1130.121E-010 | WXGA       | Multi-touch  | No            | No          | No                  |
| 15.0" single-touch           | 5AP1120.1505-000 | XGA        | Single-touch | No            | No          | Yes                 |
| 15.0" single-touch with keys | 5AP1180.1505-000 | XGA        | Single-touch | Yes           | No          | Yes                 |
| 15.0" single-touch with keys | 5AP1181.1505-000 | XGA        | Single-touch | Yes           | Yes         | Yes                 |
| 15.6" single-touch           | 5AP1120.156B-000 | HD         | Single-touch | No            | No          | No                  |
| 15.6" multi-touch            | 5AP1130.156C-000 | FHD        | Multi-touch  | No            | No          | No                  |
| 15.6" multi-touch            | 5AP1130.156C-001 | FHD        | Multi-touch  | No            | No          | No                  |
| 18.5" multi-touch            | 5AP1130.185C-000 | FHD        | Multi-touch  | No            | No          | No                  |
| 19.0" single-touch           | 5AP1120.1906-000 | SXGA       | Single-touch | No            | No          | Yes                 |

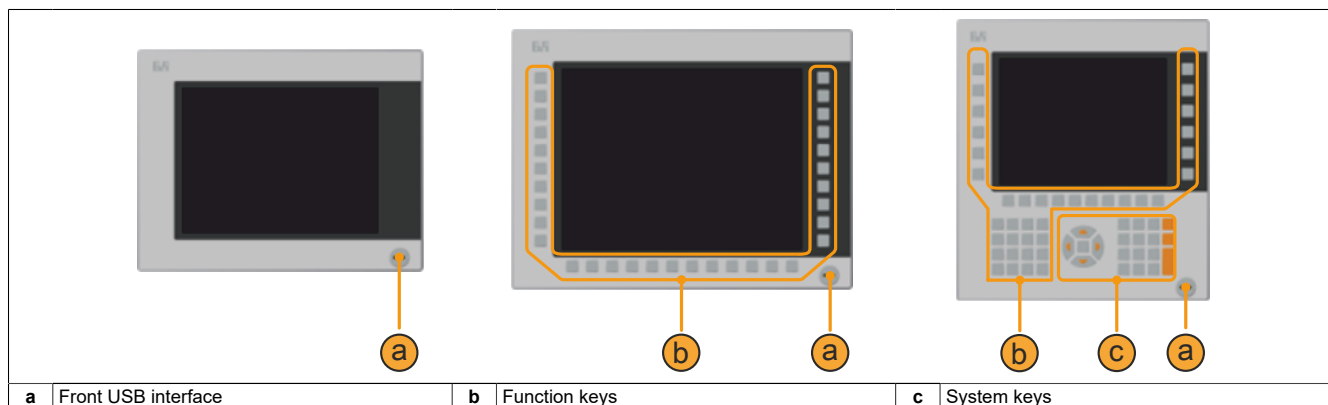

#### 4.1.5.1 Slide-in labels

Panels with keys are delivered with inserted, transparent slide-in labels in the function keys. These can be labeled by hand.

It is also possible to download a template for slide-in labels with individual captions from the B&R website ([www.br-automation.com](http://www.br-automation.com)).

The slots provided for slide-in labels are accessible on the rear of the Automation Panel devices.

### 4.1.5.2 Key and LED configuration

Each key and LED can be individually configured and adapted to the application. Various tools from B&R are available for configuration:

- B&R Key Editor for Windows operating systems
- B&R KCF Editor for Windows operating systems
- Visual Components

Keys and LEDs from each device are processed by the matrix controller in a bit string of 128 bits each.

The positions of the keys and LEDs in the matrix are displayed as hardware numbers and can be read directly on the target system using B&R tools and the ADI Control Center.

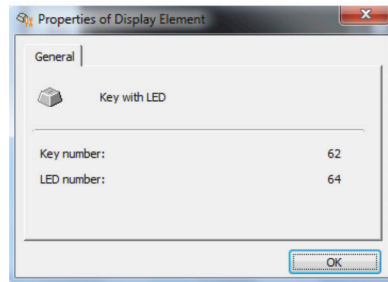

B&R Key Editor

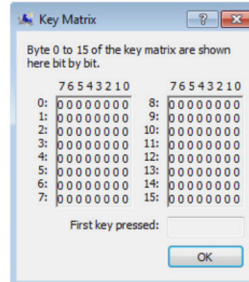

ADI Control Center

#### Keys and LEDs in the matrix:

- Hardware numbers of keys are specified in the following with black indexes.
- Hardware numbers of LEDs are specified in the following with blue indexes.

#### Illustration examples:

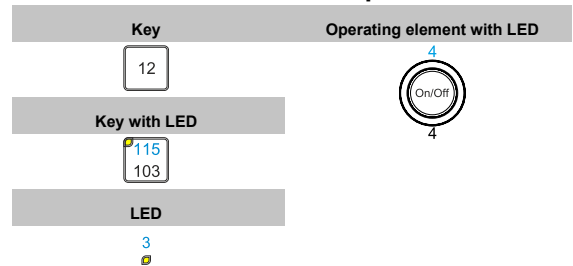

### 5AP1151.0573-000

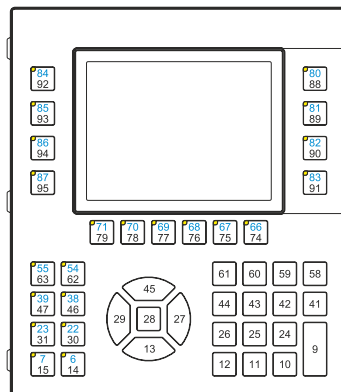

5AP1180.1043-000

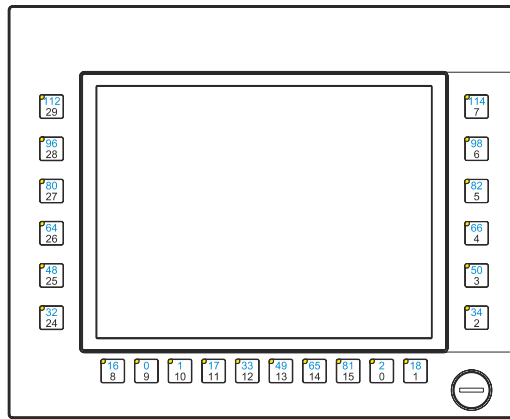

5AP1181.1043-000

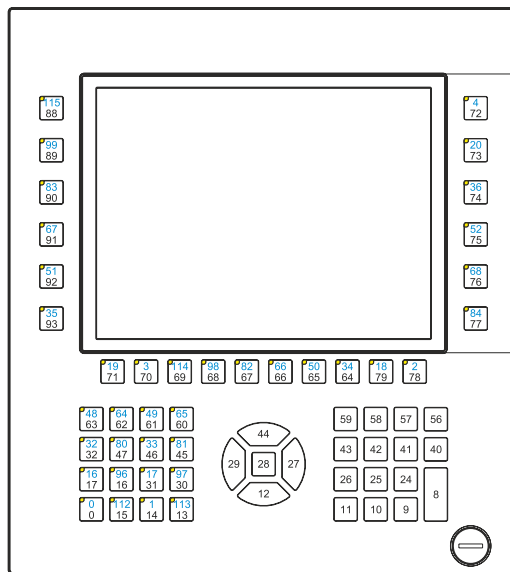

5AP1182.1043-000

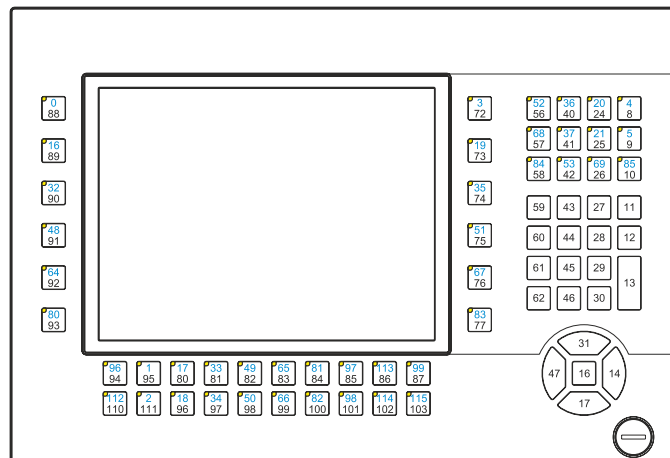

5AP1180.1505-000

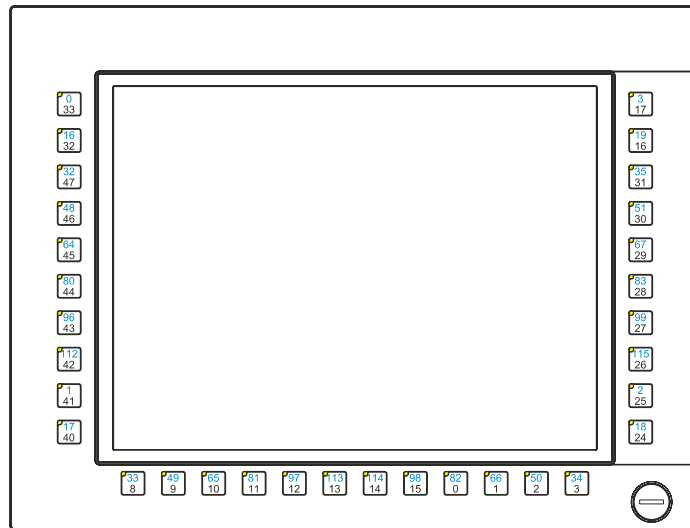

5AP1181.1505-000

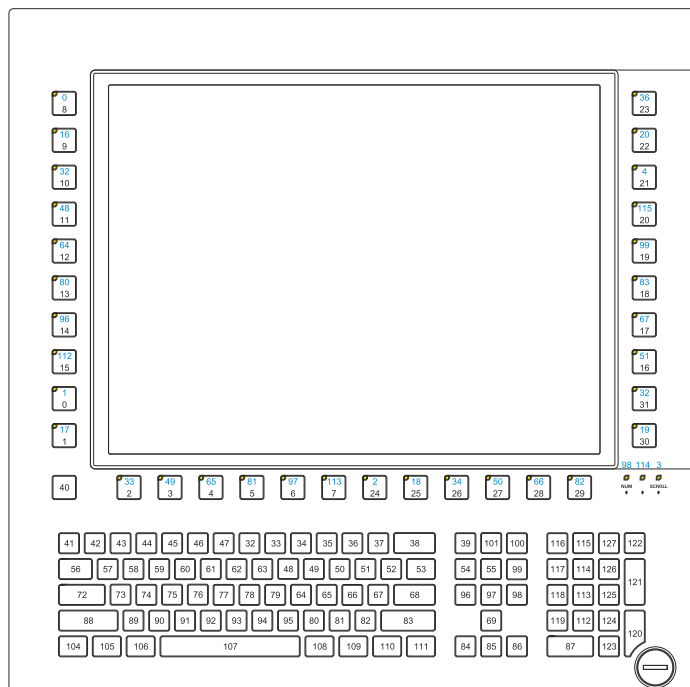

### 4.1.5.3 USB interface

The following AP1000 panels are equipped with a USB 2.0 interface on the front panel. This is equipped with a USB interface cover. IP65 protection (front) is only provided if the USB interface cover is correctly installed.

- 5AP11xx.1043-000
- 5AP1120.1214-000
- 5AP11xx.1505-000
- 5AP1120.1906-000

## Warning!

USB peripheral devices can be connected to the USB interfaces. Due to the variety of USB devices available on the market, B&R cannot guarantee their functionality. The functionality of USB devices available from B&R is ensured.

## Caution!

Due to the general PC specification, this interface must be handled with the utmost care with regard to EMC, cable routing, etc.

### Front USB

The front USB interface is available for service purposes.

| Front USB                               |   |
|---|---|
| Standard                                | USB 2.0   |
| Variant                                 | Type A, female  |
| Transfer rate                           | Low speed (1.5 Mbit/s)<br>Full speed (12 Mbit/s)<br>High speed (480 Mbit/s) |
| Current-carrying capacity <sup>1)</sup> | Max. 500 mA   |
| Cable length                            | Max. 5 m (without hub)  |
| -                                       |   |

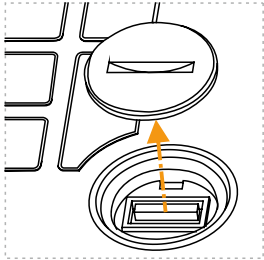

1) The USB interface is protected by a maintenance-free "USB current-limiting switch" (max. 500 mA).

## 4.2 Individual components

### 4.2.1 System units

#### 4.2.1.1 5PPC2100.BYxx-000

##### 4.2.1.1.1 General information

PPC2100 system units consist of a CPU board, main memory and housing. It includes all interfaces; in addition, an interface option can be installed. The main memory is permanently soldered to the CPU board and cannot be replaced or upgraded.

- Intel Atom processors
- Intel Bay Trail platform
- DDR3 memory
- Intel HD Graphics
- 1x CFast slot
- Slot for 1 interface option

##### 4.2.1.1.2 Order data

| Order number      | Short description  | Figure  |
|-------------------|--|---|
|                   | <b>System units</b>  |  |
| 5PPC2100.BY01-000 | PPC2100 system unit - Intel Atom E3815 1.46 GHz - Single core - 1 GB SDRAM - For Automation Panel 923/933/1000   |   |
| 5PPC2100.BY11-000 | PPC2100 system unit - Intel Atom E3825 1.33 GHz - Dual core - 1 GB SDRAM - For Automation Panel 923/933/1000   |   |
| 5PPC2100.BY22-000 | PPC2100 system unit - Intel Atom E3826 1.46 GHz - Dual core - 2 GB SDRAM - For Automation Panel 923/933/1000   |   |
| 5PPC2100.BY34-000 | PPC2100 system unit - Intel Atom E3827 1.75 GHz - Dual core - 4 GB SDRAM - For Automation Panel 923/933/1000   |   |
| 5PPC2100.BY44-000 | PPC2100 system unit - Intel Atom E3845 1.91 GHz - Quad core - 4 GB SDRAM - For Automation Panel 923/933/1000   |   |
| 5PPC2100.BY48-000 | PPC2100 system unit - Intel Atom E3845 1.91 GHz - Quad core - 8 GB SDRAM - For Automation Panel 923/933/1000   |   |
|                   | <b>Required accessories</b>  |   |
|                   | <b>CFast cards</b>   |   |
| 5CFAST.016G-00    | CFast 16 GB SLC  |   |
| 5CFAST.032G-00    | CFast 32 GB SLC  |   |
| 5CFAST.032G-10    | CFast 32 GB MLC  |   |
| 5CFAST.064G-10    | CFast 64 GB MLC  |   |
| 5CFAST.128G-10    | CFast 128 GB MLC   |   |
| 5CFAST.256G-10    | CFast 256 GB MLC   |   |
|                   | <b>Optional accessories</b>  |   |
|                   | <b>Interface options</b>   |   |
| 5ACCIF01.FPCC-000 | Interface card - 2x CAN interfaces - 1x X2X Link interface - 1x POWERLINK interface - 512 kB nvSRAM - For APC2100/PPC2100/APC2200/PPC2200 - Only available with a new device                     |   |
| 5ACCIF01.FPCS-000 | Interface card - 1x RS485 interface - 1x CAN interface - 1x POWERLINK interface - 32 kB FRAM - For APC2100/PPC2100/APC2200/PPC2200 - Only available with a new device                            |   |
| 5ACCIF01.FPLK-000 | Interface card - 1x POWERLINK interface - Integrated 2-port hub - 512 kB nvSRAM - For APC2100/PPC2100/APC2200/PPC2200 - Only available with a new device   |   |
| 5ACCIF01.FPLS-000 | Interface card - 1x RS232 interface - 1x POWERLINK interface - 32 kB FRAM - For APC2100/PPC2100/APC2200/PPC2200 - Only available with a new device   |   |
| 5ACCIF01.FPLS-001 | Interface card - 1x RS232 interface - 1x POWERLINK interface - 512 kB nvSRAM - For APC2100/PPC2100/APC2200/PPC2200 - Only available with a new device  |   |
| 5ACCIF01.FPSC-000 | Interface card - 1x RS232 interface - 1x CAN interface - 1x POWERLINK interface - 32 kB FRAM - For APC2100/PPC2100/APC2200/PPC2200 - Only available with a new device                            |   |
| 5ACCIF01.FPSC-001 | Interface card - 1x RS232 interface - 1x CAN interface - 1x X2X Link Interface - 1x POWERLINK interface - 512 kB nvSRAM - For APC2100/PPC2100/APC2200/PPC2200 - Only available with a new device |   |
| 5ACCIF01.FSS0-000 | Interface card - 2x RS422/RS485 interface - For APC2100/PPC2100/APC2200/PPC2200 - Only available with a new device   |   |
| 5ACCIF01.ICAN-000 | Interface card - 1x CAN interface - For APC2100/PPC2100/APC2200/PPC2200 - Only available with a new device   |   |
| 5ACCIF01.IS00-000 | Interface card - 1x RS232 interface - For APC2100/PPC2100/APC2200/PPC2200 - Only available with a new device   |   |

4.2.1.1.3 Technical data

| Order number  | 5PPC2100.<br>BY01-000   | 5PPC2100.<br>BY11-000 | 5PPC2100.<br>BY22-000 | 5PPC2100.<br>BY34-000 | 5PPC2100.<br>BY44-000   | 5PPC2100.<br>BY48-000 |
|---|---|-----------------------|-----------------------|-----------------------|---|-----------------------|
| <b>General information</b>                              |   |                       |                       |                       |   |                       |
| LEDs  | Power, CFast, Link, Run   |                       |                       |                       |   |                       |
| B&R ID code   | 0xE522  | 0xE524                | 0xE545                | 0xE547                | 0xE54B  | 0xED0B                |
| Cooling   | Passive via housing   |                       |                       |                       |   |                       |
| Power button  | Yes   |                       |                       |                       |   |                       |
| Reset button  | Yes   |                       |                       |                       |   |                       |
| Buzzer  | No  |                       |                       |                       |   |                       |
| Certifications  |   |                       |                       |                       |   |                       |
| CE  | Yes   |                       |                       |                       |   |                       |
| UKCA  | Yes   |                       |                       |                       |   |                       |
| UL  | cULus E115267<br>Industrial control equipment   |                       |                       |                       |   |                       |
| HazLoc  | cULus HazLoc E180196<br>Industrial control equipment<br>for hazardous locations<br>Class I, Division 2, Groups ABCD, T4 |                       |                       |                       |   |                       |
| DNV   | -   |                       |                       |                       | Temperature: <b>B</b> (0 to 55°C)<br>Humidity: <b>B</b> (up to 100%)<br>Vibration: <b>A</b> (0.7 g)<br>EMC: <b>B</b> (bridge and open deck) |                       |
| LR  | -   |                       |                       |                       | ENV3  |                       |
| KR  | -   |                       |                       |                       | Yes   |                       |
| ABS   | -   |                       |                       |                       | Yes   |                       |
| BV  | -   |                       |                       |                       | <b>EC31B</b><br>Temperature: 5 - 55°C<br>Vibration: 0.7 g<br>EMC: Bridge and open deck  |                       |
| <b>Controller</b>                                       |   |                       |                       |                       |   |                       |
| Bootloader  | UEFI BIOS   |                       |                       |                       |   |                       |
| <b>Processor</b>  |   |                       |                       |                       |   |                       |
| Type  | Intel Atom E3815  | Intel Atom E3825      | Intel Atom E3826      | Intel Atom E3827      | Intel Atom E3845  |                       |
| Clock frequency   | 1460 MHz  | 1330 MHz              | 1460 MHz              | 1750 MHz              | 1910 MHz  |                       |
| Number of cores   | 1   | 2                     |                       |                       | 4   |                       |
| Architecture  | 22 nm   |                       |                       |                       |   |                       |
| Thermal design power (TDP)                              | 5 W   | 6 W                   | 7 W                   | 8 W                   | 10 W  |                       |
| L2 cache  | 512 kB  | 1 MB                  |                       |                       | 2 MB  |                       |
| Intel 64 architecture                                   | Yes   |                       |                       |                       |   |                       |
| Intel Hyper-Threading Technology                        | No  |                       |                       |                       |   |                       |
| Intel vPro Technology                                   | No  |                       |                       |                       |   |                       |
| Intel Virtualization Technology (VT-x)                  | Yes   |                       |                       |                       |   |                       |
| Intel Virtualization Technology for Directed I/O (VT-d) | No  |                       |                       |                       |   |                       |
| Enhanced Intel SpeedStep Technology                     | Yes   |                       |                       |                       |   |                       |
| Chipset   | Intel Bay Trail   |                       |                       |                       |   |                       |
| <b>Real-time clock</b>                                  |   |                       |                       |                       |   |                       |
| Accuracy  | At 25°C: Typ. 12 ppm (1 second) per day <sup>1)</sup>   |                       |                       |                       |   |                       |
| Retention time <sup>2)</sup>                            | Typ. approx. 400 h<br>Min. approx. 200 h  |                       |                       |                       |   |                       |
| Battery-backed  | No  |                       |                       |                       |   |                       |
| <b>Power failure logic</b>                              |   |                       |                       |                       |   |                       |
| Controller  | MTCX <sup>3)</sup>  |                       |                       |                       |   |                       |
| Buffer time   | 10 ms   |                       |                       |                       |   |                       |
| <b>Memory</b>   |   |                       |                       |                       |   |                       |
| Type  | DDR3 SDRAM  |                       |                       |                       |   |                       |
| Memory size   | 1 GB  |                       | 2 GB                  | 4 GB                  |   | 8 GB                  |
| Speed   | DDR3L-1067  |                       |                       | DDR3L-1333            |   |                       |
| Memory interface width                                  | Single channel  |                       |                       |                       |   | Dual channel          |
| Removable   | No  |                       |                       |                       |   |                       |
| <b>Graphics</b>   |   |                       |                       |                       |   |                       |
| Controller  | Intel HD Graphics   |                       |                       |                       |   |                       |
| Max. dynamic graphics frequency                         | 400 MHz   | 533 MHz               | 667 MHz               | 792 MHz               |   |                       |
| Color depth   | Max. 32-bit   |                       |                       |                       |   |                       |
| DirectX support   | 11  |                       |                       |                       |   |                       |
| OpenGL support  | 4.0   |                       |                       |                       |   |                       |
| Power management  | ACPI 4.0  |                       |                       |                       |   |                       |
| <b>Interfaces</b>                                       |   |                       |                       |                       |   |                       |
| <b>CFast slot</b>                                       |   |                       |                       |                       |   |                       |
| Quantity  | 1   |                       |                       |                       |   |                       |
| Type  | SATA II (SATA 3.0 Gbit/s)   |                       |                       |                       |   |                       |

| Order number                        | 5PPC2100.<br>BY01-000  | 5PPC2100.<br>BY11-000 | 5PPC2100.<br>BY22-000 | 5PPC2100.<br>BY34-000 | 5PPC2100.<br>BY44-000 | 5PPC2100.<br>BY48-000 |
|-------------------------------------|--|-----------------------|-----------------------|-----------------------|-----------------------|-----------------------|
| <b>USB</b>                          |  |                       |                       |                       |                       |                       |
| Quantity                            | 2  |                       |                       |                       |                       |                       |
| Type                                | 1x USB 3.0<br>1x USB 2.0   |                       |                       |                       |                       |                       |
| Variant                             | Type A   |                       |                       |                       |                       |                       |
| Transfer rate                       | Low speed (1.5 Mbit/s), full speed (12 Mbit/s), high speed (480 Mbit/s) to SuperSpeed (5 Gbit/s) <sup>4)</sup> |                       |                       |                       |                       |                       |
| Current-carrying capacity           | Max. 1 A per connection  |                       |                       |                       |                       |                       |
| <b>Ethernet</b>                     |  |                       |                       |                       |                       |                       |
| Quantity                            | 2  |                       |                       |                       |                       |                       |
| Variant                             | RJ45, shielded   |                       |                       |                       |                       |                       |
| Transfer rate                       | 10/100/1000 Mbit/s   |                       |                       |                       |                       |                       |
| Max. baud rate                      | 1 Gbit/s   |                       |                       |                       |                       |                       |
| <b>Slots</b>                        |  |                       |                       |                       |                       |                       |
| Interface option <sup>5)</sup>      | 1  |                       |                       |                       |                       |                       |
| <b>Support</b>                      |  |                       |                       |                       |                       |                       |
| Software                            | Automation Studio  |                       |                       |                       |                       |                       |
|                                     | Up to V4.12  |                       |                       |                       |                       |                       |
| <b>Electrical properties</b>        |  |                       |                       |                       |                       |                       |
| Nominal voltage                     | 24 VDC ±25% <sup>6)</sup>  |                       |                       |                       |                       |                       |
| Nominal current                     | 3.5 A  |                       |                       |                       |                       |                       |
| Inrush current                      | Typ. 6 A, max. 10 A for < 300 µs   |                       |                       |                       |                       |                       |
| Overvoltage category per EN 61131-2 | II   |                       |                       |                       |                       |                       |
| Galvanic isolation                  | Yes  |                       |                       |                       |                       |                       |
| <b>Operating conditions</b>         |  |                       |                       |                       |                       |                       |
| Pollution degree per EN 61131-2     | Pollution degree 2   |                       |                       |                       |                       |                       |
| Degree of protection per EN 60529   | Back: IP20 (front: depends on the panel used) <sup>7)</sup>  |                       |                       |                       |                       |                       |
| <b>Ambient conditions</b>           |  |                       |                       |                       |                       |                       |
| Elevation                           | Operation  |                       |                       |                       |                       |                       |
|                                     | Max. 3000 m (component-dependent) <sup>8)</sup>  |                       |                       |                       |                       |                       |
| <b>Mechanical properties</b>        |  |                       |                       |                       |                       |                       |
| Dimensions                          |  |                       |                       |                       |                       |                       |
| Width                               | 190 mm   |                       |                       |                       |                       |                       |
| Height                              | 115 mm   |                       |                       |                       |                       |                       |
| Depth                               | 29.7 mm  |                       |                       |                       |                       |                       |
| Weight                              | 577 g  |                       |                       |                       |                       |                       |

- 1) At max. specified ambient temperature: Typ. 58 ppm (5 seconds) - worst case 220 ppm (19 seconds).
- 2) To achieve the specified values for the self-discharge time, the product must be supplied with power for min. 8 hours.
- 3) Maintenance Controller Extended
- 4) The SuperSpeed transfer rate (5 Gbit/s) is only possible with USB 3.0.
- 5) The interface option cannot be replaced.
- 6) IEC 61010-2-201 requirements must be observed.
- 7) Only if all interface covers are installed.
- 8) The maximum ambient temperature is typically derated 1°C per 1000 meters starting at 500 m above sea level.

## 4.2.2 AP9x3 panels

### 4.2.2.1 5AP923.1215-00

#### 4.2.2.1.1 General information

- Panel for AP9x3, PPC900, PPC2100, PPC2200 or PPC3100
- 12.1" TFT XGA color display
- Single-touch (analog resistive)
- Control cabinet installation

#### 4.2.2.1.2 Order data

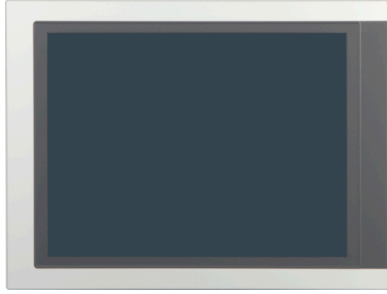
| Order number   | Short description  | Figure  |
|----------------|--|---|
|                | <b>Panels</b>  |   |
| 5AP923.1215-00 | Automation Panel 12.1" XGA TFT - 1024 x 768 pixels (4:3) - Single-touch (analog resistive) - Control cabinet installation - Landscape format - For PPC900/PPC2100/PPC3100/PPC2200 - For link modules |  |

#### 4.2.2.1.3 Technical data

### Information:

The following specified characteristic data, features and limit values are only valid for these individual components and may differ from those of the complete system. The data specified for the complete system applies to the complete system in which an individual component is used.

| Order number                       | 5AP923.1215-00  |
|------------------------------------|---|
| <b>General information</b>         |   |
| B&R ID code                        | 0xE1B0  |
| Certifications                     |   |
| CE                                 | Yes   |
| UKCA                               | Yes   |
| UL                                 | cULus E115267<br>Industrial control equipment   |
| HazLoc                             | cULus HazLoc E180196<br>Industrial control equipment<br>for hazardous locations<br>Class I, Division 2, Groups ABCD, T4 |
| <b>Display</b>                     |   |
| Type                               | TFT color   |
| Diagonal                           | 12.1"   |
| Colors                             | 16.7 million  |
| Resolution                         | XGA, 1024 x 768 pixels  |
| Contrast                           | 700:1   |
| Viewing angles                     |   |
| Horizontal                         | Direction R = 80° / Direction L = 80°   |
| Vertical                           | Rev. F0 and later: Direction U = 70° / Direction D = 70°<br>Rev. < F0: Direction U = 80° / Direction D = 80°            |
| Backlight                          |   |
| Type                               | LED   |
| Brightness (dimnable)              | Typ. 25 to 500 cd/m <sup>2</sup>  |
| Half-brightness time <sup>1)</sup> | 50,000 h  |
| Touch screen <sup>2)</sup>         |   |
| Technology                         | Analog, resistive   |
| Controller                         | B&R, serial, 12-bit   |
| Transmittance                      | 81% ±3%   |
| <b>Operating conditions</b>        |   |
| Pollution degree per EN 61131-2    | Pollution degree 2  |
| Degree of protection per EN 60529  | Front: IP65<br>Back: IP20 (only with installed link module or installed system unit)                                    |
| Degree of protection per UL 50     | Front: Type 4X indoor use only  |

|                                  |                       |
|----------------------------------|-----------------------|
| <b>Order number</b>              | <b>5AP923.1215-00</b> |
| <b>Mechanical properties</b>     |                       |
| Front                            |                       |
| Frame                            | Aluminum, coated      |
| Design                           | Black                 |
| Panel overlay                    |                       |
| Material                         | Polyester             |
| Light background color           | RAL 9006              |
| Dark border color around display | RAL 7024              |
| Gasket                           | 3 mm fixed gasket     |
| Dimensions                       |                       |
| Width                            | 315 mm                |
| Height                           | 239 mm                |
| Weight                           | 2200 g                |

- 1) At 25°C ambient temperature. Reducing the brightness by 50% can increase the half-brightness time by approximately 50%.
- 2) Touch screen drivers for approved operating systems are available for download in the Downloads section of the B&R website ([www.br-automation.com](http://www.br-automation.com)).

#### 4.2.2.1.4 Dimensions

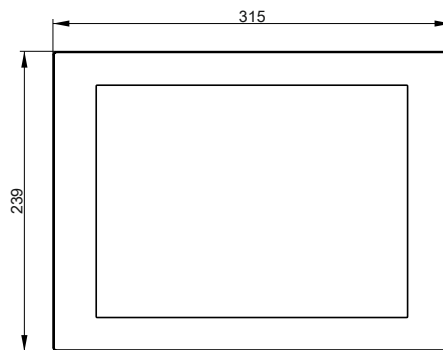

#### 4.2.2.1.5 Temperature/Humidity diagram

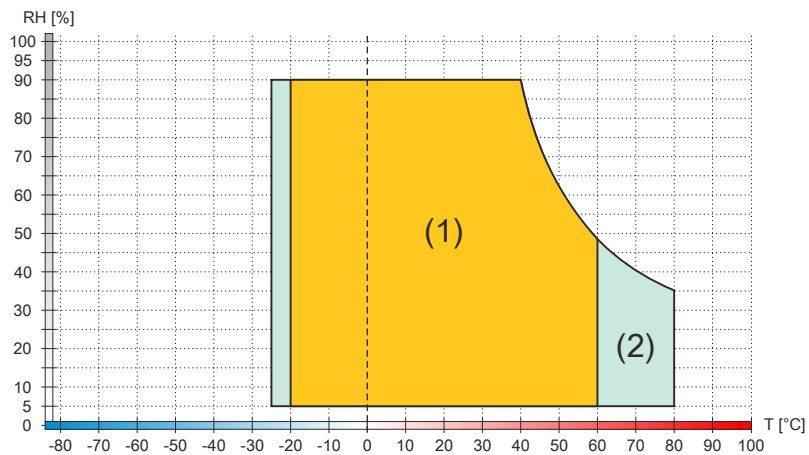

| Diagram legend |                       |        |   |
|----------------|-----------------------|--------|---|
| (1)            | Operation             | T [°C] | Temperature in °C   |
| (2)            | Storage and transport | RH [%] | Relative humidity (RH) in percent and <b>non-condensing</b> |

### 4.2.2.2 5AP923.1505-00

#### 4.2.2.2.1 General information

- Panel for AP9x3, PPC900, PPC2100, PPC2200 or PPC3100
- 15.0" TFT XGA color display
- Single-touch (analog resistive)
- Control cabinet installation

#### 4.2.2.2.2 Order data

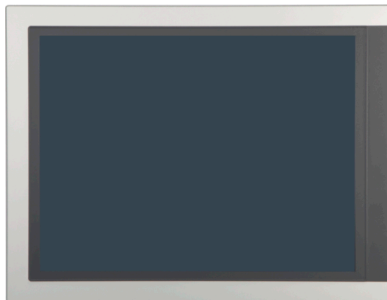
| Order number   | Short description  | Figure  |
|----------------|--|---|
| 5AP923.1505-00 | Automation Panel 15.0" XGA TFT - 1024 x 768 pixels (4:3) - Single-touch (analog resistive) - Control cabinet installation - Landscape format - For PPC900/PPC2100/PPC3100/PPC2200 - For link modules |  |

#### 4.2.2.2.3 Technical data

### Information:

The following specified characteristic data, features and limit values are only valid for these individual components and may differ from those of the complete system. The data specified for the complete system applies to the complete system in which an individual component is used.

| Order number                       | 5AP923.1505-00  |
|------------------------------------|---|
| <b>General information</b>         |   |
| B&R ID code                        | 0xE169  |
| Certifications                     |   |
| CE                                 | Yes   |
| UKCA                               | Yes   |
| UL                                 | cULus E115267<br>Industrial control equipment   |
| HazLoc                             | cULus HazLoc E180196<br>Industrial control equipment<br>for hazardous locations<br>Class I, Division 2, Groups ABCD, T4                     |
| DNV                                | Temperature: <b>B</b> (0 to 55°C)<br>Humidity: <b>B</b> (up to 100%)<br>Vibration: <b>A</b> (0.7 g)<br>EMC: <b>B</b> (bridge and open deck) |
| LR                                 | ENV3  |
| KR                                 | Yes   |
| ABS                                | Yes   |
| BV                                 | <b>EC31B</b><br>Temperature: 5 - 55°C<br>Vibration: 0.7 g<br>EMC: Bridge and open deck  |
| <b>Display</b>                     |   |
| Type                               | TFT color   |
| Diagonal                           | 15.0"   |
| Colors                             | 16.7 million  |
| Resolution                         | XGA, 1024 x 768 pixels  |
| Contrast                           | 700:1   |
| Viewing angles                     |   |
| Horizontal                         | Direction R = 80° / Direction L = 80°   |
| Vertical                           | Direction U = 70° / Direction D = 70°   |
| Backlight                          |   |
| Type                               | LED   |
| Brightness (dimnable)              | Typ. 20 to 400 cd/m <sup>2</sup>  |
| Half-brightness time <sup>1)</sup> | 50,000 h  |
| Touch screen <sup>2)</sup>         |   |
| Technology                         | Analog, resistive   |
| Controller                         | B&R, serial, 12-bit   |
| Transmittance                      | 81% ±3%   |

|                                   |  |
|-----------------------------------|--|
| <b>Order number</b>               | <b>5AP923.1505-00</b>  |
| <b>Operating conditions</b>       |  |
| Pollution degree per EN 61131-2   | Pollution degree 2   |
| Degree of protection per EN 60529 | Front: IP65<br>Back: IP20 (only with installed link module or installed system unit) |
| Degree of protection per UL 50    | Front: Type 4X indoor use only   |
| <b>Mechanical properties</b>      |  |
| Front                             |  |
| Frame                             | Aluminum, coated   |
| Design                            | Black  |
| Panel overlay                     |  |
| Material                          | Polyester  |
| Light background color            | RAL 9006   |
| Dark border color around display  | RAL 7024   |
| Gasket                            | 3 mm fixed gasket  |
| <b>Dimensions</b>                 |  |
| Width                             | 370 mm   |
| Height                            | 288 mm   |
| Weight                            | 3700 g   |

- 1) At 25°C ambient temperature. Reducing the brightness by 50% can increase the half-brightness time by approximately 50%.
- 2) Touch screen drivers for approved operating systems are available for download in the Downloads section of the B&R website ([www.br-automation.com](http://www.br-automation.com)).

#### 4.2.2.2.4 Dimensions

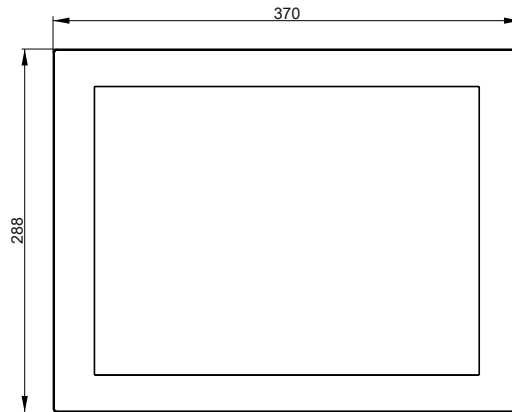

#### 4.2.2.2.5 Temperature/Humidity diagram

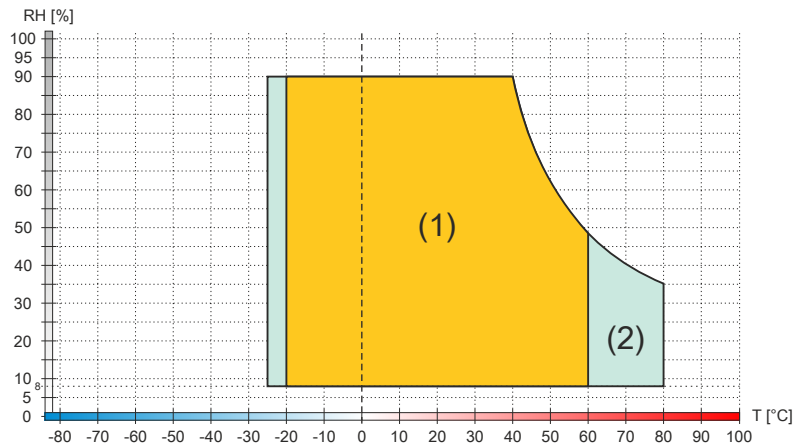

| Diagram legend |                       |        |   |
|----------------|-----------------------|--------|---|
| (1)            | Operation             | T [°C] | Temperature in °C   |
| (2)            | Storage and transport | RH [%] | Relative humidity (RH) in percent and <b>non-condensing</b> |

### 4.2.2.3 5AP923.1906-00

#### 4.2.2.3.1 General information

- Panel for AP9x3, PPC900, PPC2100, PPC2200 or PPC3100
- 19.0" TFT SXGA color display
- Single-touch (analog resistive)
- Control cabinet installation

#### 4.2.2.3.2 Order data

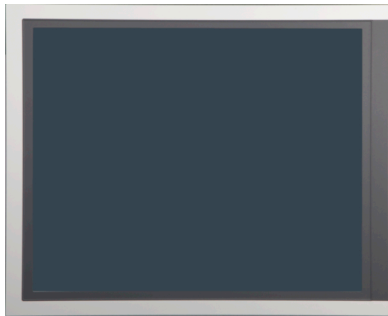
| Order number   | Short description  | Figure  |
|----------------|--|---|
| 5AP923.1906-00 | <b>Panels</b><br>Automation Panel 19.0" SXGA TFT - 1280 x 1024 pixels (5:4)<br>- Single-touch (analog resistive) - Control cabinet installation -<br>Landscape format - For PPC900/PPC2100/PPC3100/PPC2200<br>- For link modules |  |

#### 4.2.2.3.3 Technical data

### Information:

The following specified characteristic data, features and limit values are only valid for these individual components and may differ from those of the complete system. The data specified for the complete system applies to the complete system in which an individual component is used.

| Order number                       | 5AP923.1906-00  |                                       |
|------------------------------------|---|---------------------------------------|
| Revision                           | D0  | E0                                    |
| <b>General information</b>         |   |                                       |
| B&R ID code                        | 0xE1B1  |                                       |
| Certifications                     |   |                                       |
| CE                                 | Yes   |                                       |
| UKCA                               | Yes   |                                       |
| UL                                 | cULus E115267<br>Industrial control equipment   |                                       |
| HazLoc                             | cULus HazLoc E180196<br>Industrial control equipment<br>for hazardous locations<br>Class I, Division 2, Groups ABCD, T4 |                                       |
| <b>Display</b>                     |   |                                       |
| Type                               | TFT color   |                                       |
| Diagonal                           | 19.0"   |                                       |
| Colors                             | 16.7 million  |                                       |
| Resolution                         | SXGA, 1280 × 1024 pixels  |                                       |
| Contrast                           | 2000:1  | 1500:1                                |
| Viewing angles                     |   |                                       |
| Horizontal                         | Direction R = 89° / Direction L = 89°   | Direction R = 85° / Direction L = 85° |
| Vertical                           | Direction U = 89° / Direction D = 89°   | Direction U = 85° / Direction D = 85° |
| Backlight                          |   |                                       |
| Type                               | LED   |                                       |
| Brightness (dimnable)              | Typ. 30 to 300 cd/m <sup>2</sup>  | Typ. 35 to 350 cd/m <sup>2</sup>      |
| Half-brightness time <sup>1)</sup> | 50,000 h  | 70,000 h                              |
| Touch screen <sup>2)</sup>         |   |                                       |
| Technology                         | Analog, resistive   |                                       |
| Controller                         | B&R, serial, 12-bit   |                                       |
| Transmittance                      | 81% ±3%   |                                       |
| <b>Operating conditions</b>        |   |                                       |
| Pollution degree per EN 61131-2    | Pollution degree 2  |                                       |
| Degree of protection per EN 60529  | Front: IP65<br>Back: IP20 (only with installed link module or installed system unit)                                    |                                       |
| Degree of protection per UL 50     | Front: Type 4X indoor use only  |                                       |

|                                  |                       |  |           |
|----------------------------------|-----------------------|--|-----------|
| <b>Order number</b>              | <b>5AP923.1906-00</b> |  |           |
| <b>Revision</b>                  | <b>D0</b>             |  | <b>E0</b> |
| <b>Mechanical properties</b>     |                       |  |           |
| Front                            |                       |  |           |
| Frame                            | Aluminum, coated      |  |           |
| Design                           | Black                 |  |           |
| Panel overlay                    |                       |  |           |
| Material                         | Polyester             |  |           |
| Light background color           | RAL 9006              |  |           |
| Dark border color around display | RAL 7024              |  |           |
| Gasket                           | 3 mm fixed gasket     |  |           |
| Dimensions                       |                       |  |           |
| Width                            | 440 mm                |  |           |
| Height                           | 358 mm                |  |           |
| Weight                           | 5800 g                |  |           |

- 1) At 25°C ambient temperature. Reducing the brightness by 50% can increase the half-brightness time by approximately 50%.
- 2) Touch screen drivers for approved operating systems are available for download in the Downloads section of the B&R website ([www.br-automation.com](http://www.br-automation.com)).

**4.2.2.3.4 Dimensions**

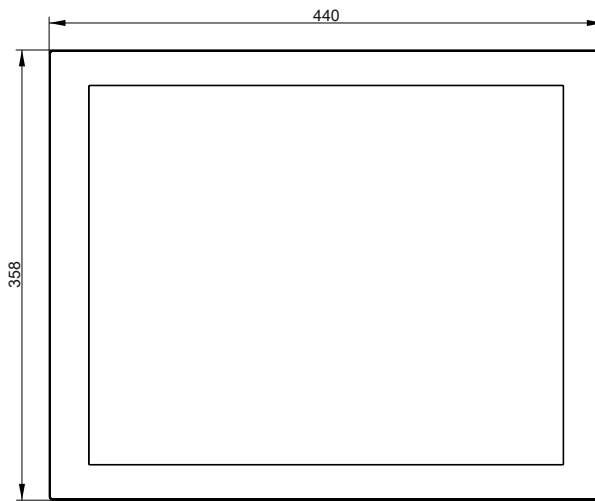

**4.2.2.3.5 Temperature/Humidity diagram**

5AP923.1906-00 ≥ Rev. E0

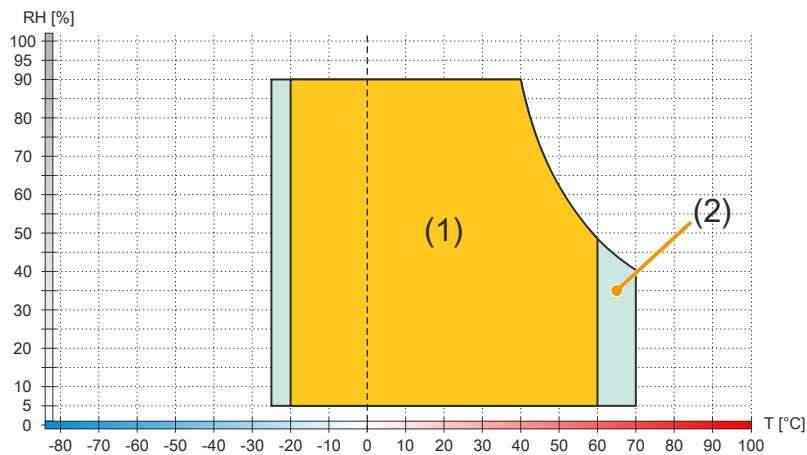

| Diagram legend |                       |        |   |
|----------------|-----------------------|--------|---|
| (1)            | Operation             | T [°C] | Temperature in °C   |
| (2)            | Storage and transport | RH [%] | Relative humidity (RH) in percent and <b>non-condensing</b> |

5AP923.1906-00 ≤ Rev. D0

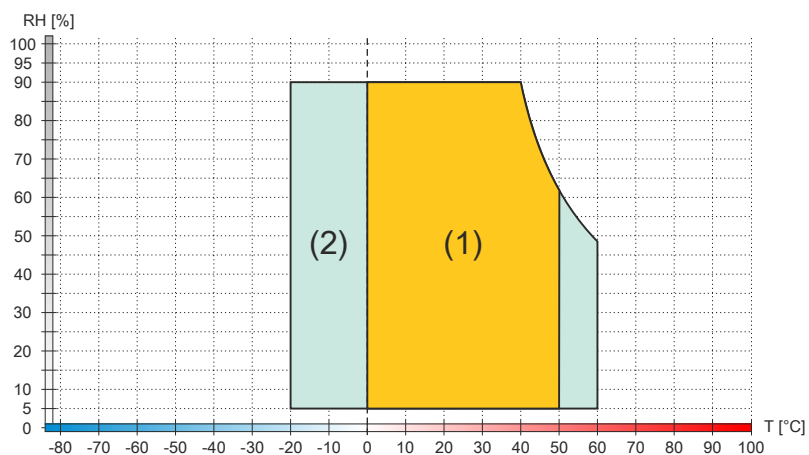

| Diagram legend |                       |        |   |
|----------------|-----------------------|--------|---|
| (1)            | Operation             | T [°C] | Temperature in °C   |
| (2)            | Storage and transport | RH [%] | Relative humidity (RH) in percent and <b>non-condensing</b> |

#### 4.2.2.4 5AP933.156B-00

##### 4.2.2.4.1 General information

- Panel for AP9x3, PPC900, PPC2100, PPC2200 or PPC3100
- 15.6" TFT HD color display
- Multi-touch (PCT)
- Control cabinet installation

##### 4.2.2.4.2 Order data

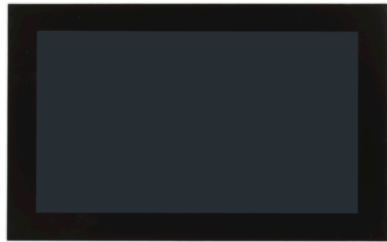
| Order number   | Short description   | Figure  |
|----------------|---|---|
| 5AP933.156B-00 | Automation Panel 15.6" HD TFT - 1366 x 768 pixels (16:9) - Multi-touch (projected capacitive) - Control cabinet installation - Landscape format - For PPC900/PPC2100/PPC3100/PPC2200 - For link modules |  |

##### 4.2.2.4.3 Technical data

### Information:

The following specified characteristic data, features and limit values are only valid for these individual components and may differ from those of the complete system. The data specified for the complete system applies to the complete system in which an individual component is used.

| Order number                       | 5AP933.156B-00   |                                       |
|------------------------------------|--|---------------------------------------|
| Revision                           | C0   | D0                                    |
| <b>General information</b>         |  |                                       |
| B&R ID code                        | 0xE16A   |                                       |
| Certifications                     |  |                                       |
| CE                                 | Yes  |                                       |
| UKCA                               | Yes  |                                       |
| UL                                 | cULus E115267<br>Industrial control equipment  |                                       |
| <b>Display</b>                     |  |                                       |
| Type                               | TFT color  |                                       |
| Diagonal                           | 15.6"  |                                       |
| Colors                             | 16.7 million   |                                       |
| Resolution                         | HD, 1366 × 768 pixels  |                                       |
| Contrast                           | 500:1  | 1000:1                                |
| Viewing angles                     |  |                                       |
| Horizontal                         | Direction R = 85° / Direction L = 85°  |                                       |
| Vertical                           | Direction U = 80° / Direction D = 80°  | Direction U = 85° / Direction D = 85° |
| Backlight                          |  |                                       |
| Type                               | LED  |                                       |
| Brightness (dimnable)              | Typ. 15 to 300 cd/m <sup>2</sup>   | Typ. 40 to 400 cd/m <sup>2</sup>      |
| Half-brightness time <sup>1)</sup> | 50,000 h   | 70,000 h                              |
| Touch screen <sup>2)</sup>         |  |                                       |
| Technology                         | Projected capacitive touch (PCT)   |                                       |
| Transmittance                      | 88% ±2%  | >90%                                  |
| <b>Operating conditions</b>        |  |                                       |
| Pollution degree per EN 61131-2    | Pollution degree 2   |                                       |
| Degree of protection per EN 60529  | Front: IP65<br>Back: IP20 (only with installed link module or installed system unit) |                                       |
| Degree of protection per UL 50     | Front: Type 4X indoor use only   |                                       |
| <b>Mechanical properties</b>       |  |                                       |
| Front                              |  |                                       |
| Frame                              | Aluminum, coated   |                                       |
| Design                             | Black  |                                       |
| Gasket                             | 3 mm fixed gasket  |                                       |
| Dimensions                         |  |                                       |
| Width                              | 414 mm   |                                       |
| Height                             | 258.5 mm   |                                       |
| Weight                             | 3850 g   |                                       |

1) At 25°C ambient temperature. Reducing the brightness by 50% can increase the half-brightness time by approximately 50%.

2) The specifications of the touch screen driver must be taken into account; see section "Multi-touch driver".

#### 4.2.2.4.4 Dimensions

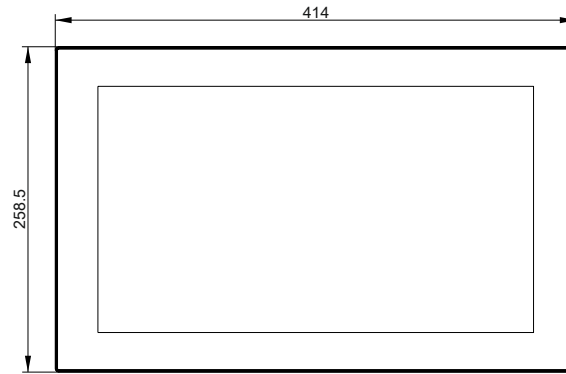

#### 4.2.2.4.5 Temperature/Humidity diagram

5AP933.156B-00 ≥ Rev. D0

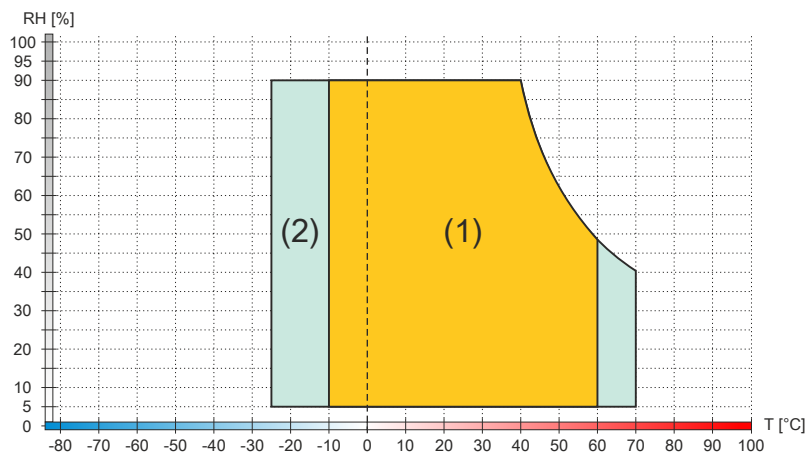

| Diagram legend |                       |        |   |
|----------------|-----------------------|--------|---|
| (1)            | Operation             | T [°C] | Temperature in °C   |
| (2)            | Storage and transport | RH [%] | Relative humidity (RH) in percent and <b>non-condensing</b> |

5AP933.156B-00 ≤ Rev. C0

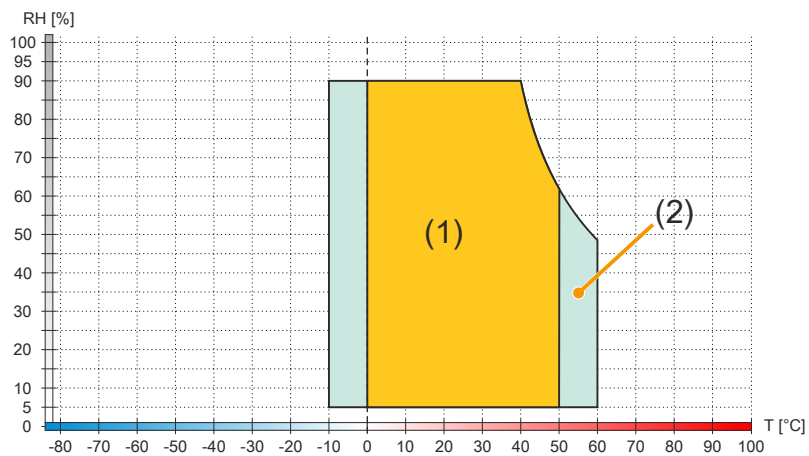

| Diagram legend |                       |        |   |
|----------------|-----------------------|--------|---|
| (1)            | Operation             | T [°C] | Temperature in °C   |
| (2)            | Storage and transport | RH [%] | Relative humidity (RH) in percent and <b>non-condensing</b> |

## 4.2.2.5 5AP933.185B-00

### 4.2.2.5.1 General information

- Panel for AP9x3, PPC900, PPC2100, PPC2200 or PPC3100
- 18.5" TFT HD color display
- Multi-touch (PCT)
- Control cabinet installation

### 4.2.2.5.2 Order data

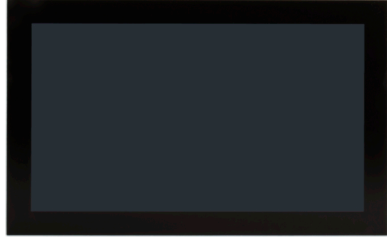
| Order number   | Short description  | Figure  |
|----------------|--|---|
| 5AP933.185B-00 | <b>Panels</b><br>Automation Panel 18.5" HD TFT - 1366 x 768 pixels (16:9) - Multi-touch (projected capacitive) - Control cabinet installation - Landscape format - For PPC900/PPC2100/PPC3100/PPC2200 - For link modules |  |

### 4.2.2.5.3 Technical data

#### Information:

The following specified characteristic data, features and limit values are only valid for these individual components and may differ from those of the complete system. The data specified for the complete system applies to the complete system in which an individual component is used.

| Order number                       | 5AP933.185B-00   |                                  |    |
|------------------------------------|--|----------------------------------|----|
| Revision                           | C0   | D0                               | K0 |
| <b>General information</b>         |  |                                  |    |
| B&R ID code                        | 0xE16B   |                                  |    |
| Certifications                     |  |                                  |    |
| CE                                 | Yes  |                                  |    |
| UKCA                               | Yes  |                                  |    |
| UL                                 | cULus E115267<br>Industrial control equipment  |                                  |    |
| <b>Display</b>                     |  |                                  |    |
| Type                               | TFT color  |                                  |    |
| Diagonal                           | 18.5"  |                                  |    |
| Colors                             | 16.7 million   |                                  |    |
| Resolution                         | HD, 1366 × 768 pixels  |                                  |    |
| Contrast                           | 1000:1   |                                  |    |
| Viewing angles                     |  |                                  |    |
| Horizontal                         | Direction R = 85° / Direction L = 85°  |                                  |    |
| Vertical                           | Direction U = 80° / Direction D = 80°  |                                  |    |
| Backlight                          |  |                                  |    |
| Type                               | LED  |                                  |    |
| Brightness (dimnable)              | Typ. 15 to 300 cd/m <sup>2</sup>   | Typ. 15 to 450 cd/m <sup>2</sup> |    |
| Half-brightness time <sup>1)</sup> | 50,000 h   |                                  |    |
| Touch screen <sup>2)</sup>         |  |                                  |    |
| Technology                         | Projected capacitive touch (PCT)   |                                  |    |
| Transmittance                      | 88% ±2%  | >90%                             |    |
| <b>Operating conditions</b>        |  |                                  |    |
| Pollution degree per EN 61131-2    | Pollution degree 2   |                                  |    |
| Degree of protection per EN 60529  | Front: IP65<br>Back: IP20 (only with installed link module or installed system unit) |                                  |    |
| Degree of protection per UL 50     | Front: Type 4X indoor use only   |                                  |    |
| <b>Mechanical properties</b>       |  |                                  |    |
| Front                              |  |                                  |    |
| Frame                              | Aluminum, coated   |                                  |    |
| Design                             | Black  |                                  |    |
| Gasket                             | 3 mm fixed gasket  |                                  |    |
| Dimensions                         |  |                                  |    |
| Width                              | 475 mm   |                                  |    |
| Height                             | 295 mm   |                                  |    |
| Weight                             | 4850 g   | Approx. 4470 g                   |    |

1) At 25°C ambient temperature. Reducing the brightness by 50% can increase the half-brightness time by approximately 50%.

2) The specifications of the touch screen driver must be taken into account; see section "Multi-touch driver".

### 4.2.2.5.4 Dimensions

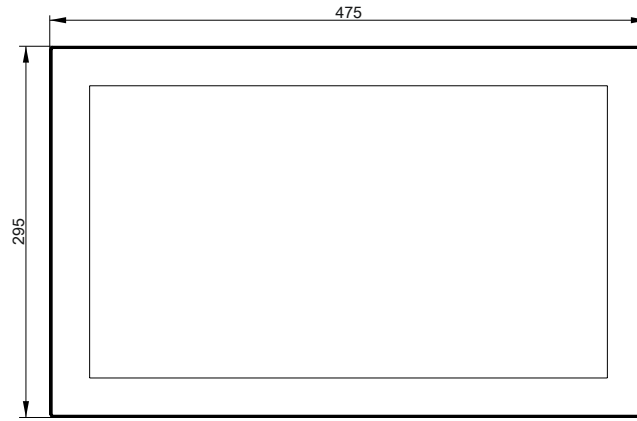

### 4.2.2.5.5 Temperature/Humidity diagram

5AP933.185B-00 ≥ Rev. D0

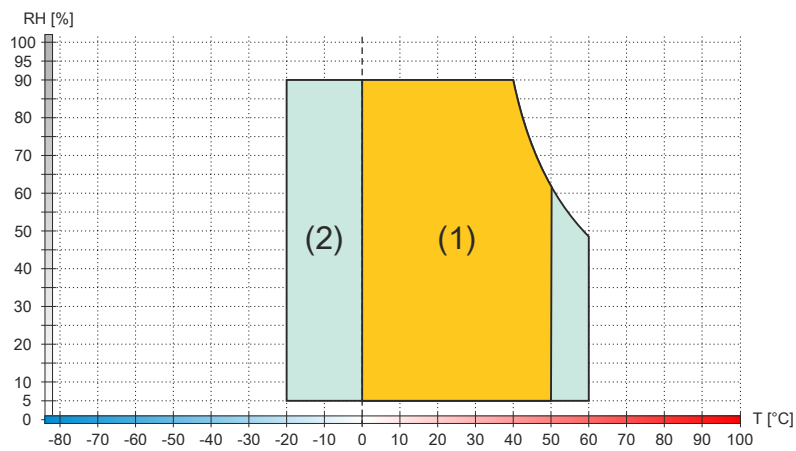

| Diagram legend |                       |        |   |
|----------------|-----------------------|--------|---|
| (1)            | Operation             | T [°C] | Temperature in °C   |
| (2)            | Storage and transport | RH [%] | Relative humidity (RH) in percent and <b>non-condensing</b> |

5AP933.185B-00 ≤ Rev. C0

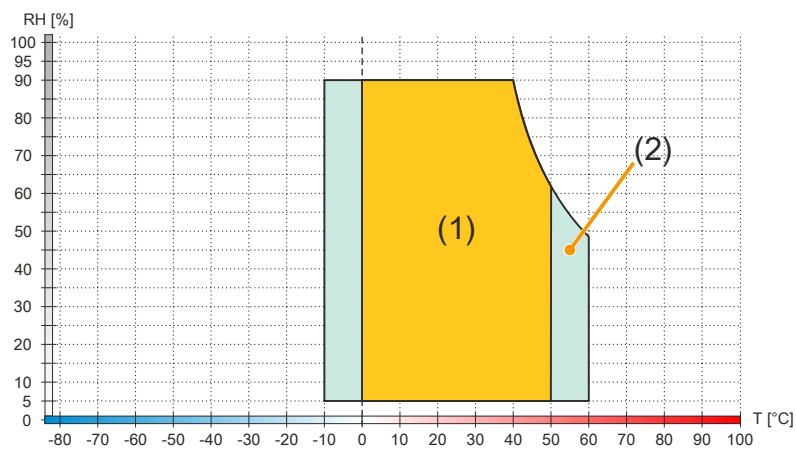

| Diagram legend |                       |        |   |
|----------------|-----------------------|--------|---|
| (1)            | Operation             | T [°C] | Temperature in °C   |
| (2)            | Storage and transport | RH [%] | Relative humidity (RH) in percent and <b>non-condensing</b> |

### 4.2.2.6 5AP933.215C-00

#### 4.2.2.6.1 General information

- Panel for AP9x3, PPC900, PPC2100, PPC2200 or PPC3100
- 21.5" TFT FHD color display
- Multi-touch (PCT)
- Control cabinet installation

#### 4.2.2.6.2 Order data

| Order number   | Short description   | Figure  |
|----------------|---|---|
| 5AP933.215C-00 | <b>Panels</b><br>Automation Panel 21.5" Full HD TFT - 1920 x 1080 pixels (16:9)<br>- Multi-touch (projected capacitive) - Control cabinet installation -<br>Landscape format - For PPC900/PPC2100/PPC3100/PPC2200<br>- For link modules |  |

#### 4.2.2.6.3 Technical data

### Information:

The following specified characteristic data, features and limit values are only valid for these individual components and may differ from those of the complete system. The data specified for the complete system applies to the complete system in which an individual component is used.

| Order number                       | 5AP933.215C-00   |        |
|------------------------------------|--|--------|
| Revision                           | C0   | D0     |
| <b>General information</b>         |  |        |
| B&R ID code                        | 0xE16C   |        |
| Certifications                     |  |        |
| CE                                 | Yes  |        |
| UKCA                               | Yes  |        |
| UL                                 | cULus E115267<br>Industrial control equipment  |        |
| <b>Display</b>                     |  |        |
| Type                               | TFT color  |        |
| Diagonal                           | 21.5"  |        |
| Colors                             | 16.7 million   |        |
| Resolution                         | FHD, 1920 × 1080 pixels  |        |
| Contrast                           | 1000:1   | 5000:1 |
| Viewing angles                     |  |        |
| Horizontal                         | Direction R = 89° / Direction L = 89°  |        |
| Vertical                           | Direction U = 89° / Direction D = 89°  |        |
| Backlight                          |  |        |
| Type                               | LED  |        |
| Brightness (dimnable)              | Typ. 12.5 to 250 cd/m <sup>2</sup>   |        |
| Half-brightness time <sup>1)</sup> | 30,000 h   |        |
| Touch screen <sup>2)</sup>         |  |        |
| Technology                         | Projected capacitive touch (PCT)   |        |
| Transmittance                      | 88% ±2%  | >90%   |
| <b>Operating conditions</b>        |  |        |
| Pollution degree per EN 61131-2    | Pollution degree 2   |        |
| Degree of protection per EN 60529  | Front: IP65<br>Back: IP20 (only with installed link module or installed system unit) |        |
| Degree of protection per UL 50     | Front: Type 4X indoor use only   |        |
| <b>Mechanical properties</b>       |  |        |
| Front                              |  |        |
| Frame                              | Aluminum, coated   |        |
| Design                             | Black  |        |
| Gasket                             | 3 mm fixed gasket  |        |
| Dimensions                         |  |        |
| Width                              | 541.5 mm   |        |
| Height                             | 333 mm   |        |
| Weight                             | 5400 g   |        |

1) At 25°C ambient temperature. Reducing the brightness by 50% can increase the half-brightness time by approximately 50%.

2) The specifications of the touch screen driver must be taken into account; see section "Multi-touch driver".

4.2.2.6.4 Dimensions

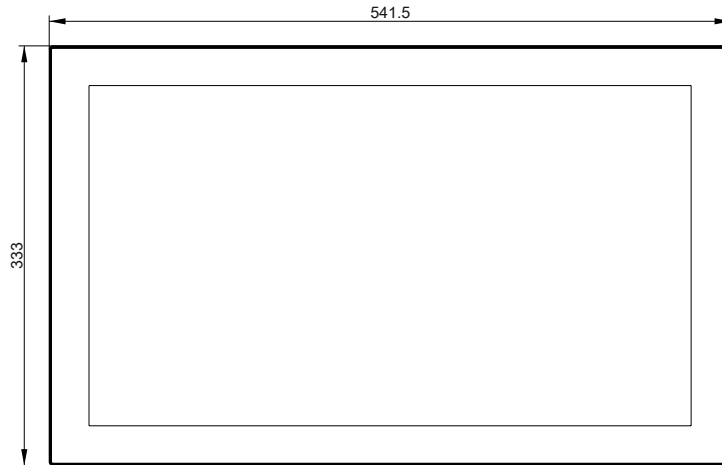

4.2.2.6.5 Temperature/Humidity diagram

5AP933.215C-00 ≥ Rev. D0

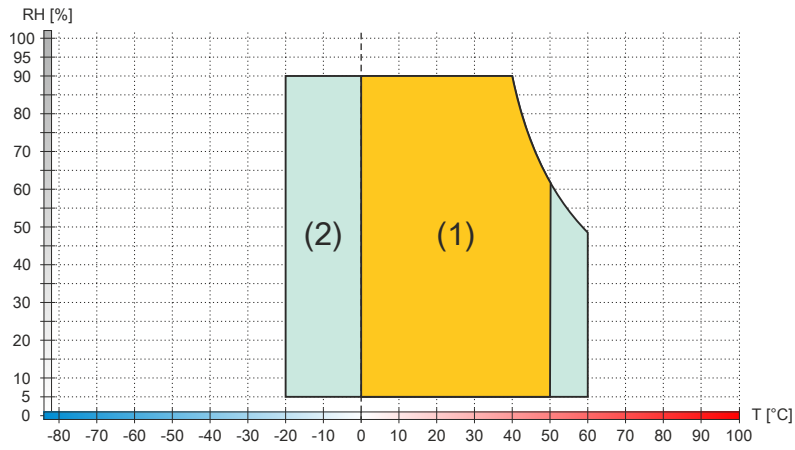

| Diagram legend |                       |        |   |
|----------------|-----------------------|--------|---|
| (1)            | Operation             | T [°C] | Temperature in °C   |
| (2)            | Storage and transport | RH [%] | Relative humidity (RH) in percent and <b>non-condensing</b> |

5AP933.215C-00 ≤ Rev. C0

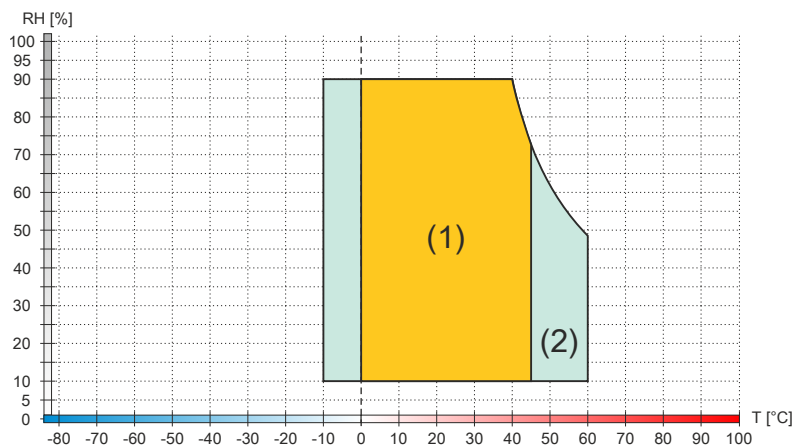

| Diagram legend |                       |        |   |
|----------------|-----------------------|--------|---|
| (1)            | Operation             | T [°C] | Temperature in °C   |
| (2)            | Storage and transport | RH [%] | Relative humidity (RH) in percent and <b>non-condensing</b> |

### 4.2.2.7 5AP933.240C-00

#### 4.2.2.7.1 General information

- Panel for AP9x3, PPC900, PPC2100, PPC2200 or PPC3100
- 24" TFT FHD color display
- Multi-touch (PCT)
- Control cabinet installation

#### 4.2.2.7.2 Order data

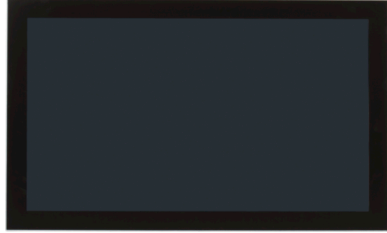
| Order number   | Short description   | Figure  |
|----------------|---|---|
| 5AP933.240C-00 | <b>Panels</b><br>Automation Panel 24.0" Full HD TFT - 1920 x 1080 pixels (16:9)<br>- Multi-touch (projected capacitive) - Control cabinet installation -<br>Landscape format - For PPC900/PPC2100/PPC3100/PPC2200<br>- For link modules |  |

#### 4.2.2.7.3 Technical data

### Information:

The following specified characteristic data, features and limit values are only valid for these individual components and may differ from those of the complete system. The data specified for the complete system applies to the complete system in which an individual component is used.

| Order number                       | 5AP933.240C-00  |      |
|------------------------------------|---|------|
| Revision                           | C0  | D0   |
| <b>General information</b>         |   |      |
| B&R ID code                        | 0xE1B4  |      |
| Certifications                     |   |      |
| CE                                 | Yes   |      |
| UKCA                               | Yes   |      |
| UL                                 | cULus E115267<br>Industrial control equipment   |      |
| DNV                                | Temperature: <b>B</b> (0 to 55°C)<br>Humidity: <b>B</b> (up to 100%)<br>Vibration: <b>A</b> (0.7 g)<br>EMC: <b>B</b> (bridge and open deck) |      |
| LR                                 | ENV3  |      |
| KR                                 | Yes   |      |
| ABS                                | Yes   |      |
| BV                                 | <b>EC31B</b><br>Temperature: 5 - 55°C<br>Vibration: 0.7 g<br>EMC: Bridge and open deck  |      |
| <b>Display</b>                     |   |      |
| Type                               | TFT color   |      |
| Diagonal                           | 24.0"   |      |
| Colors                             | 16.7 million  |      |
| Resolution                         | FHD, 1920 × 1080 pixels   |      |
| Contrast                           | 5000:1  |      |
| Viewing angles                     |   |      |
| Horizontal                         | Direction R = 89° / Direction L = 89°   |      |
| Vertical                           | Direction U = 89° / Direction D = 89°   |      |
| Backlight                          |   |      |
| Type                               | LED   |      |
| Brightness (dimnable)              | Typ. 30 to 300 cd/m <sup>2</sup>  |      |
| Half-brightness time <sup>1)</sup> | 50,000 h  |      |
| Touch screen <sup>2)</sup>         |   |      |
| Technology                         | Projected capacitive touch (PCT)  |      |
| Transmittance                      | 88% ±2%   | >90% |
| <b>Operating conditions</b>        |   |      |
| Pollution degree per EN 61131-2    | Pollution degree 2  |      |
| Degree of protection per EN 60529  | Front: IP65<br>Back: IP20 (only with installed link module or installed system unit)  |      |
| Degree of protection per UL 50     | Front: Type 4X indoor use only  |      |

## Technical data

|                              |                   |  |    |
|------------------------------|-------------------|--|----|
| Order number                 | 5AP933.240C-00    |  |    |
| Revision                     | C0                |  | D0 |
| <b>Mechanical properties</b> |                   |  |    |
| Front                        |                   |  |    |
| Frame                        | Aluminum, coated  |  |    |
| Design                       | Black             |  |    |
| Gasket                       | 3 mm fixed gasket |  |    |
| Dimensions                   |                   |  |    |
| Width                        | 598.5 mm          |  |    |
| Height                       | 364 mm            |  |    |
| Weight                       | Approx. 7800 g    |  |    |

- 1) At 25°C ambient temperature. Reducing the brightness by 50% can increase the half-brightness time by approximately 50%.
- 2) The specifications of the touch screen driver must be taken into account; see section "Multi-touch driver".

### 4.2.2.7.4 Dimensions

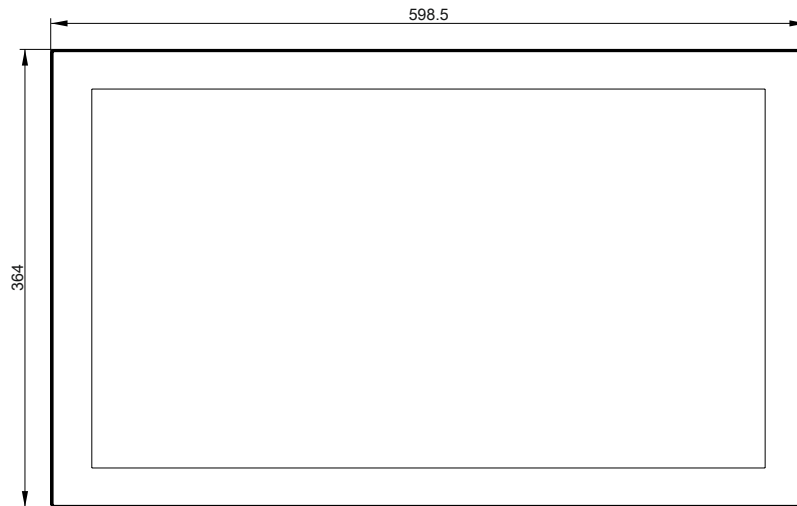

### 4.2.2.7.5 Temperature/Humidity diagram

5AP933.240C-00 ≥ Rev. D0

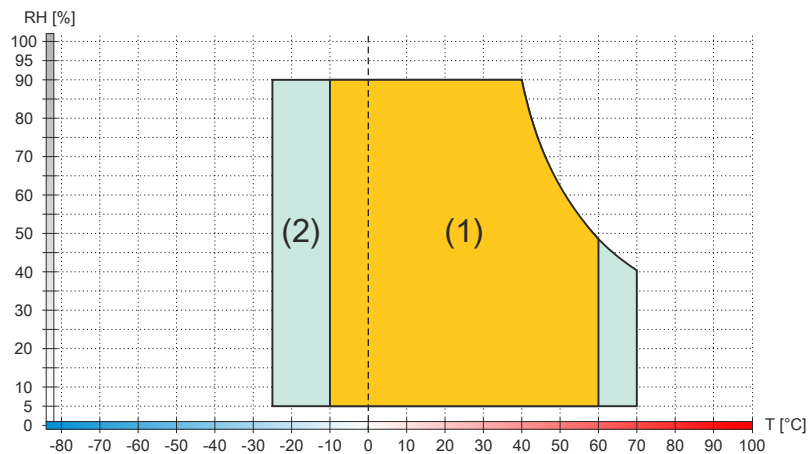

| Diagram legend |                       |        |   |
|----------------|-----------------------|--------|---|
| (1)            | Operation             | T [°C] | Temperature in °C   |
| (2)            | Storage and transport | RH [%] | Relative humidity (RH) in percent and <b>non-condensing</b> |

5AP933.240C-00 ≤ Rev. C0

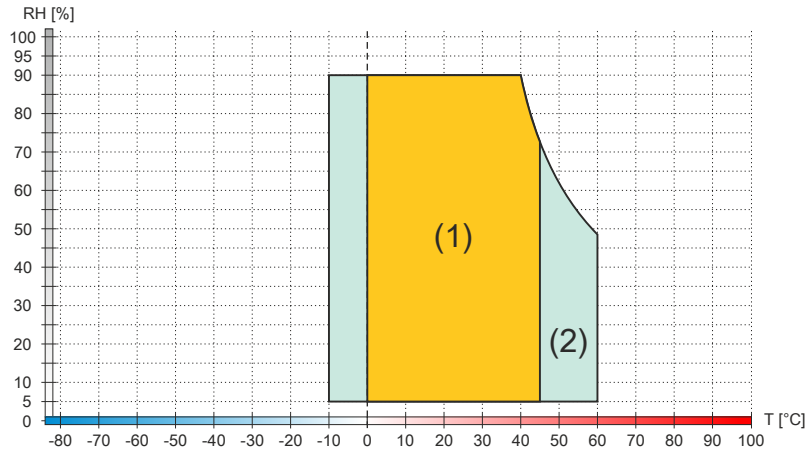

Diagram legend

| Diagram legend |                       |        |   |
|----------------|-----------------------|--------|---|
| (1)            | Operation             | T [°C] | Temperature in °C   |
| (2)            | Storage and transport | RH [%] | Relative humidity (RH) in percent and <b>non-condensing</b> |

## 4.2.3 AP1000 panels

### 4.2.3.1 5AP1120.0573-000

#### 4.2.3.1.1 General information

- Panel for AP1000, PPC2100 or PPC2200
- 5.7" TFT VGA color display
- Single-touch (analog resistive)
- Control cabinet installation

#### 4.2.3.1.2 Order data

| Order number     | Short description  | Figure  |
|------------------|--|---|
|                  | <b>Panels</b>  |   |
| 5AP1120.0573-000 | Automation Panel 5.7" VGA TFT - 640 x 480 pixels (4:3) - Single-touch (analog resistive) - Control cabinet installation - Landscape format - For PPC2100 / PPC2200 / link modules - Compatible with 5PP520.0573-00 |  |

#### 4.2.3.1.3 Technical data

### Information:

The following specified characteristic data, features and limit values are only valid for these individual components and may differ from those of the complete system. The data specified for the complete system applies to the complete system in which an individual component is used.

| Order number                       | 5AP1120.0573-000  |                                       |
|------------------------------------|---|---------------------------------------|
| Revision                           | D0  | E0                                    |
| <b>General information</b>         |   |                                       |
| B&R ID code                        | 0xE7AA  |                                       |
| Certifications                     |   |                                       |
| CE                                 | Yes   |                                       |
| UKCA                               | Yes   |                                       |
| UL                                 | cULus E115267   |                                       |
| HazLoc                             | Industrial control equipment<br>cULus HazLoc E180196<br>Industrial control equipment<br>for hazardous locations<br>Class I, Division 2, Groups ABCD, T4 |                                       |
| <b>Display</b>                     |   |                                       |
| Type                               | TFT color   |                                       |
| Diagonal                           | 5.7"  |                                       |
| Colors                             | 262,144   |                                       |
| Resolution                         | VGA, 640 x 480 pixels   |                                       |
| Contrast                           | 850:1   | 800:1                                 |
| Viewing angles                     |   |                                       |
| Horizontal                         | Direction R = 80° / Direction L = 80°   |                                       |
| Vertical                           | Direction U = 80° / Direction D = 80°   | Direction U = 70° / Direction D = 70° |
| Backlight                          |   |                                       |
| Type                               | LED   |                                       |
| Brightness (dimnable)              | Typ. 20 to 400 cd/m <sup>2</sup>  | Typ. 22.5 to 450 cd/m <sup>2</sup>    |
| Half-brightness time <sup>1)</sup> | 50,000 h  |                                       |
| Touch screen <sup>2)</sup>         |   |                                       |
| Technology                         | Analog, resistive   |                                       |
| Controller                         | B&R, serial, 12-bit   |                                       |
| Transmittance                      | 81% ±3%   |                                       |
| <b>Operating conditions</b>        |   |                                       |
| Pollution degree per EN 61131-2    | Pollution degree 2  |                                       |
| Degree of protection per EN 60529  | Front: IP65<br>Back: IP20 (only with installed link module or installed system unit)  |                                       |
| Degree of protection per UL 50     | Front: Type 4X indoor use only  |                                       |

|                                  |                              |  |           |
|----------------------------------|------------------------------|--|-----------|
| <b>Order number</b>              | <b>5AP1120.0573-000</b>      |  |           |
| <b>Revision</b>                  | <b>D0</b>                    |  | <b>E0</b> |
| <b>Mechanical properties</b>     |                              |  |           |
| Front <sup>3)</sup>              |                              |  |           |
| Frame                            | Aluminum, naturally anodized |  |           |
| Panel overlay                    |                              |  |           |
| Material                         | Polyester                    |  |           |
| Light background color           | RAL 9006                     |  |           |
| Dark border color around display | RAL 7024                     |  |           |
| Gasket                           | 3 mm fixed gasket            |  |           |
| <b>Dimensions</b>                |                              |  |           |
| Width                            | 212 mm                       |  |           |
| Height                           | 156 mm                       |  |           |
| Weight                           | 1100 g                       |  |           |

- 1) At 25°C ambient temperature. Reducing the brightness by 50% can increase the half-brightness time by approximately 50%.
- 2) Touch screen drivers for approved operating systems are available for download in the Downloads section of the B&R website ([www.br-automation.com](http://www.br-automation.com)).
- 3) Visual deviations in color and surface quality are possible due to process or batch conditions.

#### 4.2.3.1.4 Dimensions

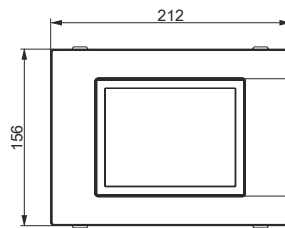

#### 4.2.3.1.5 Requirements

5.7" AP1000 panels are supported starting with the following firmware versions:

- Firmware V03.11 or later with SDL/DVI receiver 5DLSL.1001-00
- Firmware V04.08 or later with SDL3 receiver 5DLSL3.1001-00
- Firmware V01.03 or later with PPC2100 system unit 5PPC2100.BYxx-000.

#### 4.2.3.1.6 Temperature/Humidity diagram

5AP1120.0573-000 ≥ Rev. E0

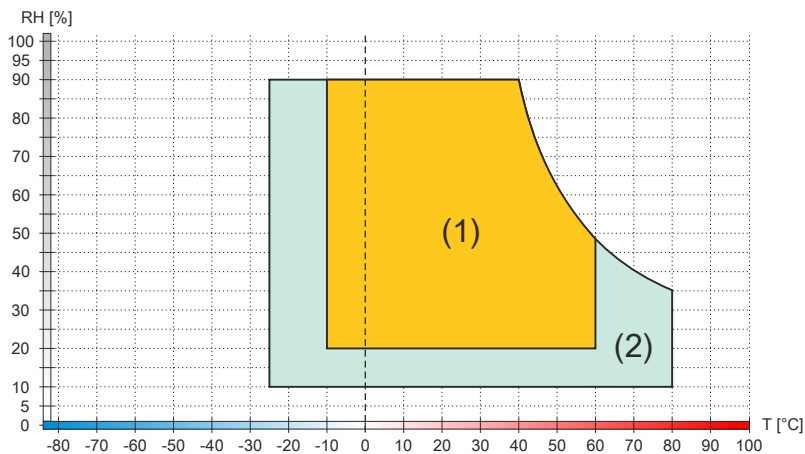

| Diagram legend |                       |        |   |
|----------------|-----------------------|--------|---|
| (1)            | Operation             | T [°C] | Temperature in °C   |
| (2)            | Storage and transport | RH [%] | Relative humidity (RH) in percent and <b>non-condensing</b> |

5AP1120.0573-000 ≤ Rev. D0

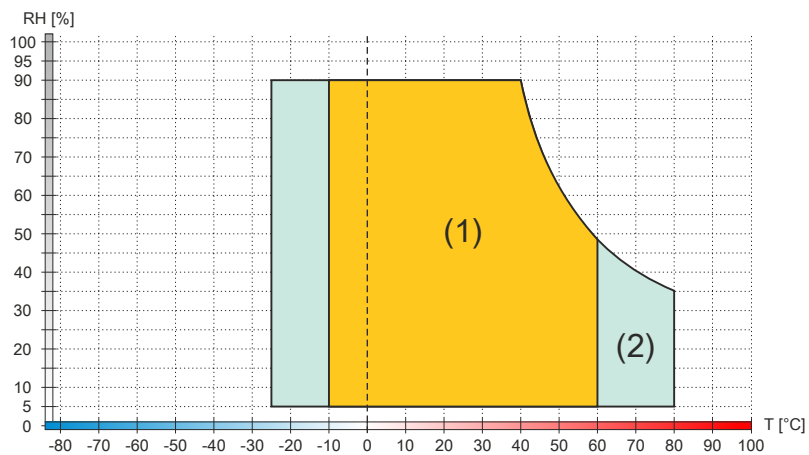

| Diagram legend |                       |        |   |
|----------------|-----------------------|--------|---|
| (1)            | Operation             | T [°C] | Temperature in °C   |
| (2)            | Storage and transport | RH [%] | Relative humidity (RH) in percent and <b>non-condensing</b> |

### 4.2.3.2 5AP1151.0573-000

#### 4.2.3.2.1 General information

- Panel for AP1000, PPC2100 or PPC2200
- 5.7" TFT VGA color display
- 22 function keys and 20 system keys
- Control cabinet installation

#### 4.2.3.2.2 Order data

| Order number     | Short description   | Figure  |
|------------------|---|---|
| 5AP1151.0573-000 | Automation Panel 5.7" VGA TFT - 640 x 480 pixels (4:3) - Control cabinet installation - Portrait format - 22 function keys and 20 system keys - For PPC2100 / PPC2200 / link modules - Compatible with 5PP551.0573-00 |  |

#### 4.2.3.2.3 Technical data

### Information:

The following specified characteristic data, features and limit values are only valid for these individual components and may differ from those of the complete system. The data specified for the complete system applies to the complete system in which an individual component is used.

| Order number                       | 5AP1151.0573-000  |                                       |
|------------------------------------|---|---------------------------------------|
| Revision                           | D0  | E0                                    |
| <b>General information</b>         |   |                                       |
| B&R ID code                        | 0xE7AB  |                                       |
| Certifications                     |   |                                       |
| CE                                 | Yes   |                                       |
| UKCA                               | Yes   |                                       |
| UL                                 | cULus E115267<br>Industrial control equipment   |                                       |
| HazLoc                             | cULus HazLoc E180196<br>Industrial control equipment<br>for hazardous locations<br>Class I, Division 2, Groups ABCD, T4 |                                       |
| <b>Display</b>                     |   |                                       |
| Type                               | TFT color   |                                       |
| Diagonal                           | 5.7"  |                                       |
| Colors                             | 262,144   |                                       |
| Resolution                         | VGA, 640 x 480 pixels   |                                       |
| Contrast                           | 850:1   | 800:1                                 |
| Viewing angles                     |   |                                       |
| Horizontal                         | Direction R = 80° / Direction L = 80°   |                                       |
| Vertical                           | Direction U = 80° / Direction D = 80°   | Direction U = 70° / Direction D = 70° |
| Backlight                          |   |                                       |
| Type                               | LED   |                                       |
| Brightness (dimnable)              | Typ. 20 to 400 cd/m <sup>2</sup>  | Typ. 22.5 to 450 cd/m <sup>2</sup>    |
| Half-brightness time <sup>1)</sup> | 50,000 h  |                                       |
| <b>Keys</b>                        |   |                                       |
| Function keys                      | 22 with LED (yellow)  |                                       |
| System keys                        | Numeric keys, cursor block  |                                       |
| Service life                       | >1,000,000 actuations at 1 ±0.3 N to 3 ±0.3 N actuating force   |                                       |
| LED luminous intensity             |   |                                       |
| Yellow                             | Typ. 38 mcd   |                                       |
| <b>Operating conditions</b>        |   |                                       |
| Pollution degree per EN 61131-2    | Pollution degree 2  |                                       |
| Degree of protection per EN 60529  | Front: IP65<br>Back: IP20 (only with installed link module or installed system unit)                                    |                                       |

## Technical data

|                                  |                                |  |           |
|----------------------------------|--------------------------------|--|-----------|
| <b>Order number</b>              | <b>5AP1151.0573-000</b>        |  |           |
| <b>Revision</b>                  | <b>D0</b>                      |  | <b>E0</b> |
| Degree of protection per UL 50   | Front: Type 4X indoor use only |  |           |
| <b>Mechanical properties</b>     |                                |  |           |
| Front <sup>2)</sup>              |                                |  |           |
| Frame                            | Aluminum, naturally anodized   |  |           |
| Panel overlay                    |                                |  |           |
| Material                         | Polyester                      |  |           |
| Light background color           | RAL 9006                       |  |           |
| Dark border color around display | RAL 7024                       |  |           |
| Gasket                           | 3 mm fixed gasket              |  |           |
| <b>Dimensions</b>                |                                |  |           |
| Width                            | 212 mm                         |  |           |
| Height                           | 245 mm                         |  |           |
| Weight                           | 1400 g                         |  |           |

- 1) At 25°C ambient temperature. Reducing the brightness by 50% can increase the half-brightness time by approximately 50%.
- 2) Visual deviations in color and surface quality are possible due to process or batch conditions.

### 4.2.3.2.4 Dimensions

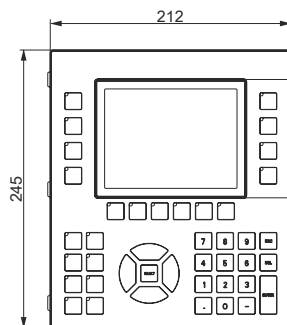

### 4.2.3.2.5 Requirements

5.7" AP1000 panels are supported starting with the following firmware versions:

- Firmware V03.11 or later with SDL/DVI receiver 5DLSDL.1001-00
- Firmware V04.08 or later with SDL3 receiver 5DLSD3.1001-00
- Firmware V01.03 or later with PPC2100 system unit 5PPC2100.BYxx-000.

### 4.2.3.2.6 Temperature/Humidity diagram

**5AP1151.0573-000 ≥ Rev. E0**

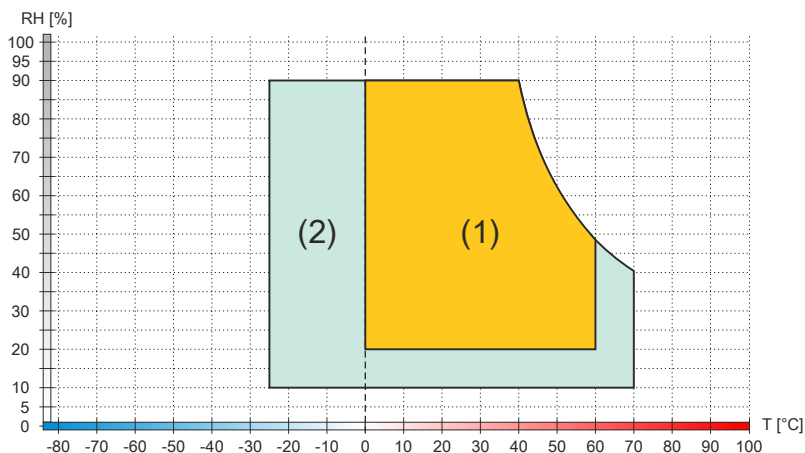

| Diagram legend |                       |        |   |
|----------------|-----------------------|--------|---|
| (1)            | Operation             | T [°C] | Temperature in °C   |
| (2)            | Storage and transport | RH [%] | Relative humidity (RH) in percent and <b>non-condensing</b> |

5AP1151.0573-000 ≤ Rev. D0

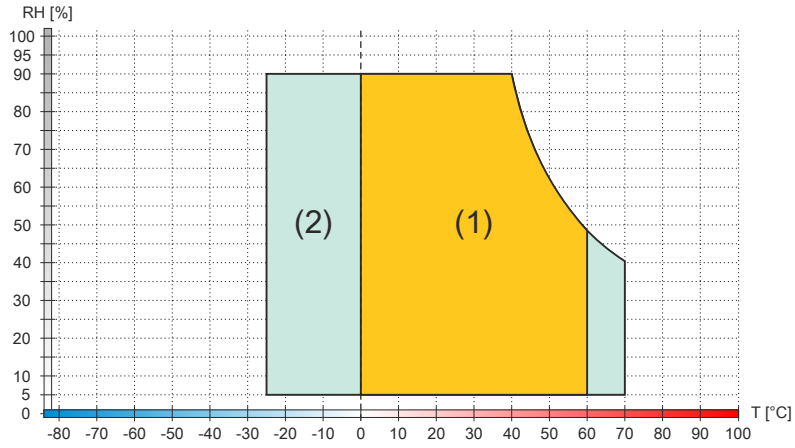

Diagram legend

|     |                       |        |   |
|-----|-----------------------|--------|---|
| (1) | Operation             | T [°C] | Temperature in °C   |
| (2) | Storage and transport | RH [%] | Relative humidity (RH) in percent and <b>non-condensing</b> |

### 4.2.3.3 5AP1120.0702-000

#### 4.2.3.3.1 General information

- Panel for AP1000, PPC2100 or PPC2200
- 7.0" TFT WVGA color display
- Single-touch (analog resistive)
- Control cabinet installation

#### 4.2.3.3.2 Order data

| Order number     | Short description   | Figure  |
|------------------|---|---|
| 5AP1120.0702-000 | Automation Panel 7" WVGA TFT - 800 x 480 pixels (16:10) - Single-touch (analog resistive) - Control cabinet installation - Landscape format - For PPC2100 / PPC2200 / link modules - Compatible with 5PP520.0702-00 |  |

#### 4.2.3.3.3 Technical data

### Information:

The following specified characteristic data, features and limit values are only valid for these individual components and may differ from those of the complete system. The data specified for the complete system applies to the complete system in which an individual component is used.

| Order number                       | 5AP1120.0702-000  |
|------------------------------------|---|
| <b>General information</b>         |   |
| B&R ID code                        | 0xE7AC  |
| Certifications                     |   |
| CE                                 | Yes   |
| UKCA                               | Yes   |
| UL                                 | cULus E115267<br>Industrial control equipment   |
| HazLoc                             | cULus HazLoc E180196<br>Industrial control equipment<br>for hazardous locations<br>Class I, Division 2, Groups ABCD, T4 |
| <b>Display</b>                     |   |
| Type                               | TFT color   |
| Diagonal                           | 7.0"  |
| Colors                             | 16.7 million  |
| Resolution                         | WVGA, 800 x 480 pixels  |
| Contrast                           | Rev. D0 and later: 550:1<br>Up to Rev. C0: 600:1  |
| Viewing angles                     |   |
| Horizontal                         | Direction R = 70° / Direction L = 70°   |
| Vertical                           | Rev. D0 and later: Direction U = 50° / Direction D = 60°<br>Up to Rev. C0: Direction U = 60° / Direction D = 60°        |
| Backlight                          |   |
| Type                               | LED   |
| Brightness (dimnable)              | Typ. 80 to 500 cd/m <sup>2</sup>  |
| Half-brightness time <sup>1)</sup> | 50,000 h  |
| Touch screen <sup>2)</sup>         |   |
| Technology                         | Analog, resistive   |
| Controller                         | B&R, serial, 12-bit   |
| Transmittance                      | 81% ±3%   |
| <b>Operating conditions</b>        |   |
| Pollution degree per EN 61131-2    | Pollution degree 2  |
| Degree of protection per EN 60529  | Front: IP65<br>Back: IP20 (only with installed link module or installed system unit)                                    |
| Degree of protection per UL 50     | Front: Type 4X indoor use only  |

|                                  |                              |
|----------------------------------|------------------------------|
| <b>Order number</b>              | <b>5AP1120.0702-000</b>      |
| <b>Mechanical properties</b>     |                              |
| Front <sup>3)</sup>              |                              |
| Frame                            | Aluminum, naturally anodized |
| Panel overlay                    |                              |
| Material                         | Polyester                    |
| Light background color           | RAL 9006                     |
| Dark border color around display | RAL 7024                     |
| Gasket                           | 3 mm fixed gasket            |
| Dimensions                       |                              |
| Width                            | 212 mm                       |
| Height                           | 156 mm                       |
| Weight                           | Approx. 900 g                |

- 1) At 25°C ambient temperature. Reducing the brightness by 50% can increase the half-brightness time by approximately 50%.
- 2) Touch screen drivers for approved operating systems are available for download in the Downloads section of the B&R website ([www.br-automation.com](http://www.br-automation.com)).
- 3) Visual deviations in color and surface quality are possible due to process or batch conditions.

#### 4.2.3.3.4 Dimensions

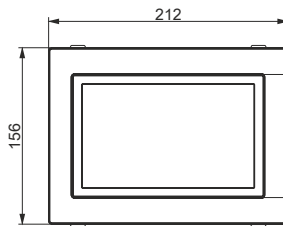

#### 4.2.3.3.5 Temperature/Humidity diagram

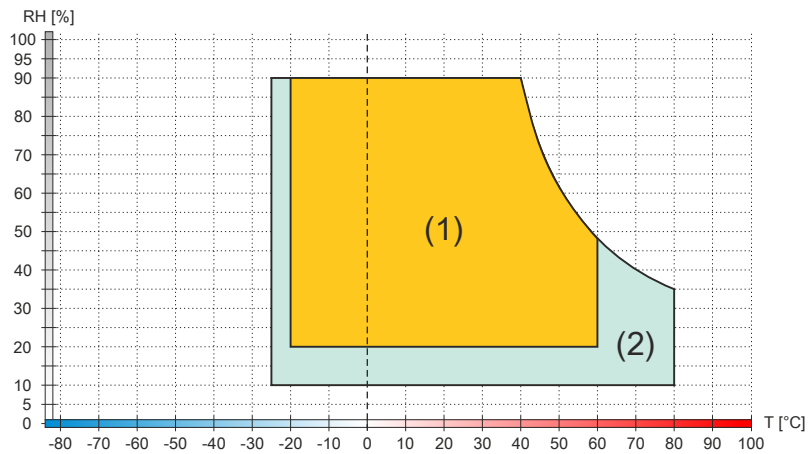

| Diagram legend |                       |        |   |
|----------------|-----------------------|--------|---|
| (1)            | Operation             | T [°C] | Temperature in °C   |
| (2)            | Storage and transport | RH [%] | Relative humidity (RH) in percent and <b>non-condensing</b> |

#### 4.2.3.4 5AP1130.0702-000

##### 4.2.3.4.1 General information

- Panel for AP1000, PPC2100 or PPC2200
- 7.0" TFT WVGA color display
- Multi-touch (projected capacitive)
- Control cabinet installation

##### 4.2.3.4.2 Order data

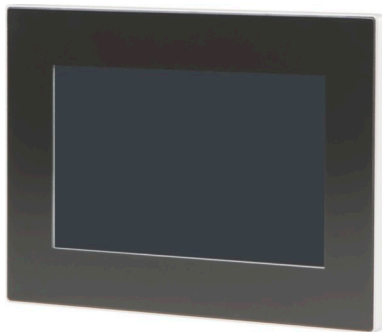
| Order number     | Short description  | Figure  |
|------------------|--|---|
| 5AP1130.0702-000 | Automation Panel 7.0" WVGA TFT - 800 x 480 pixels (16:10) - Multi-touch (projected capacitive) - Control cabinet installation - Landscape format - For PPC2100 / PPC2200 / link modules - Compatible with 5PP520.0702-00 |  |

##### 4.2.3.4.3 Technical data

### Information:

The following specified characteristic data, features and limit values are only valid for these individual components and may differ from those of the complete system. The data specified for the complete system applies to the complete system in which an individual component is used.

| Order number                       | 5AP1130.0702-000  |
|------------------------------------|---|
| <b>General information</b>         |   |
| B&R ID code                        | 0xEB61  |
| Certifications                     |   |
| CE                                 | Yes   |
| UKCA                               | Yes   |
| UL                                 | cULus E115267<br>Industrial control equipment   |
| HazLoc                             | cULus HazLoc E180196<br>Industrial control equipment<br>for hazardous locations<br>Class I, Division 2, Groups ABCD, T4 |
| <b>Display</b>                     |   |
| Type                               | TFT color   |
| Diagonal                           | 7.0"  |
| Colors                             | 16.7 million  |
| Resolution                         | WVGA, 800 x 480 pixels  |
| Contrast                           | Rev. G0 and later: 550:1<br>Up to Rev. F0: 600:1  |
| Viewing angles                     |   |
| Horizontal                         | Direction R = 70° / Direction L = 70°   |
| Vertical                           | Rev. G0 and later: Direction U = 50° / Direction D = 60°<br>Up to Rev. F0: Direction U = 60° / Direction D = 60°        |
| Backlight                          |   |
| Type                               | LED   |
| Brightness (dimnable)              | Typ. 80 to 500 cd/m <sup>2</sup>  |
| Half-brightness time <sup>1)</sup> | 50,000 h  |
| Touch screen <sup>2)</sup>         |   |
| Technology                         | Projected capacitive touch (PCT)  |
| Transmittance                      | See "Appendix A - Touch screen".  |
| <b>Operating conditions</b>        |   |
| Pollution degree per EN 61131-2    | Pollution degree 2  |
| Degree of protection per EN 60529  | Front: IP65<br>Back: IP20 (only with installed link module or installed system unit)                                    |
| Degree of protection per UL 50     | Front: Type 4X indoor use only  |

|                              |                         |
|------------------------------|-------------------------|
| <b>Order number</b>          | <b>5AP1130.0702-000</b> |
| <b>Mechanical properties</b> |                         |
| Front <sup>3)</sup>          |                         |
| Frame                        | Aluminum, coated        |
| Design                       | Black                   |
| Gasket                       | 3 mm fixed gasket       |
| <b>Dimensions</b>            |                         |
| Width                        | 209 mm                  |
| Height                       | 153 mm                  |
| Weight                       | 1200 g                  |

- 1) At 25°C ambient temperature. Reducing the brightness by 50% can increase the half-brightness time by approximately 50%.
- 2) The specifications for the touch screen driver must be taken into account. See chapter 4 "Software", section 2 "Multi-touch drivers".
- 3) Visual deviations in color and surface quality are possible due to process or batch conditions.

**4.2.3.4.4 Dimensions**

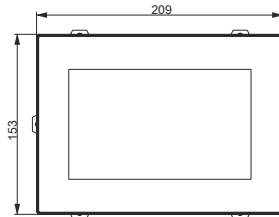

**4.2.3.4.5 Temperature/Humidity diagram**

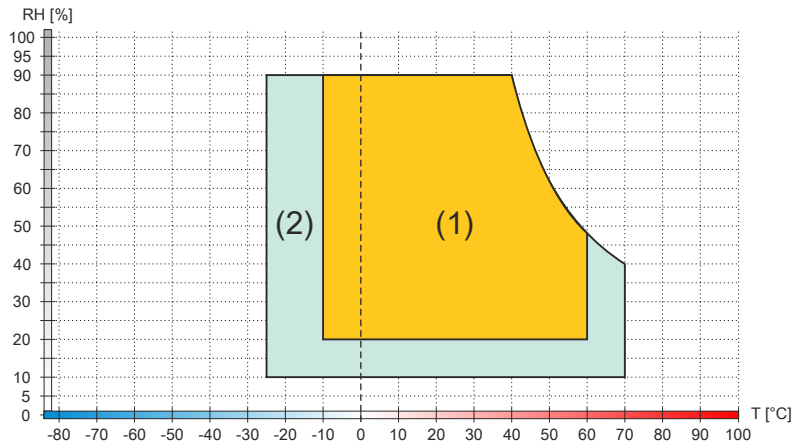

| Diagram legend |                       |        |   |
|----------------|-----------------------|--------|---|
| (1)            | Operation             | T [°C] | Temperature in °C   |
| (2)            | Storage and transport | RH [%] | Relative humidity (RH) in percent and <b>non-condensing</b> |

### 4.2.3.5 5AP1130.101D-000

#### 4.2.3.5.1 General information

- Panel for AP1000, PPC2100, PPC2200 or PPC3100
- 10.1" TFT WUXGA color display
- Multi-touch (projected capacitive)
- Brighter display
- Control cabinet installation

#### 4.2.3.5.2 Order data

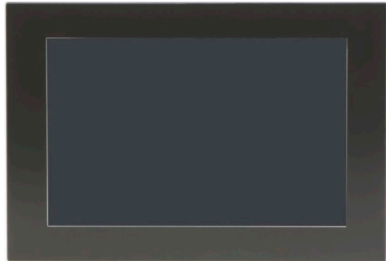
| Order number     | Short description  | Figure  |
|------------------|--|---|
| 5AP1130.101D-000 | <b>Panels</b><br>Automation Panel 10.1" High Resolution - 1920 x 1200 pixels (16:10) - Multi-touch (projected capacitive) - Control cabinet installation - Landscape format - For PPC2100/PPC3100/PPC2200 - For link modules |  |

#### 4.2.3.5.3 Technical data

### Information:

The following specified characteristic data, features and limit values are only valid for these individual components and may differ from those of the complete system. The data specified for the complete system applies to the complete system in which an individual component is used.

| Order number                       | 5AP1130.101D-000   |
|------------------------------------|--|
| <b>General information</b>         |  |
| B&R ID code                        | 0x27AD   |
| Certifications                     |  |
| CE                                 | Yes  |
| UKCA                               | Yes  |
| UL                                 | cULus E115267<br>Industrial control equipment  |
| HazLoc                             | In preparation   |
| <b>Display</b>                     |  |
| Type                               | TFT color  |
| Diagonal                           | 10.1"  |
| Colors                             | 16.7 million   |
| Resolution                         | WUXGA, 1920 x 1200 pixels  |
| Contrast                           | 800:1  |
| Air bonding                        | Yes  |
| Viewing angles                     |  |
| Horizontal                         | Direction R = 85° / Direction L = 85°  |
| Vertical                           | Direction U = 85° / Direction D = 85°  |
| <b>Backlight</b>                   |  |
| Type                               | LED  |
| Brightness (dimnable)              | Typ. 80 to 800 cd/m <sup>2</sup>   |
| Half-brightness time <sup>1)</sup> | 40,000 h   |
| <b>Touch screen <sup>2)</sup></b>  |  |
| Technology                         | Projected capacitive touch (PCT)   |
| Transmittance                      | See "Appendix A - Touch screen".   |
| <b>Operating conditions</b>        |  |
| Pollution degree per EN 61131-2    | Pollution degree 2   |
| Degree of protection per EN 60529  | Front: IP65<br>Back: IP20 (only with installed link module or installed system unit) |
| Degree of protection per UL 50     | Front: Type 4X indoor use only   |
| <b>Mechanical properties</b>       |  |
| Front <sup>3)</sup>                |  |
| Frame                              | Aluminum, coated   |
| Design                             | Black  |
| Gasket                             | 3 mm fixed gasket  |

|                     |                         |
|---------------------|-------------------------|
| <b>Order number</b> | <b>5AP1130.101D-000</b> |
| Dimensions          |                         |
| Width               | 279 mm                  |
| Height              | 191 mm                  |
| Weight              | Approx. 2000 g          |

- 1) At 25°C ambient temperature. Reducing the brightness by 50% can increase the half-brightness time by approximately 50%.
- 2) The specifications for the touch screen driver must be taken into account. See section "Multi-touch drivers" in chapter 4 "Software".
- 3) Visual deviations in color and surface quality are possible due to process or batch conditions.

**4.2.3.5.4 Dimensions**

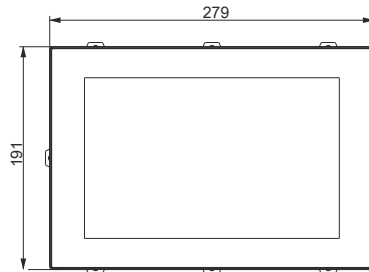

**4.2.3.5.5 Temperature/Humidity diagram**

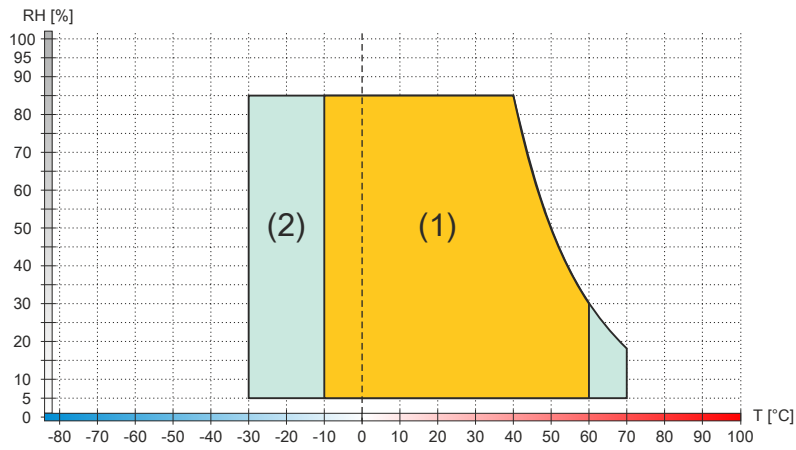

| Diagram legend |                       |        |   |
|----------------|-----------------------|--------|---|
| (1)            | Operation             | T [°C] | Temperature in °C   |
| (2)            | Storage and transport | RH [%] | Relative humidity (RH) in percent and <b>non-condensing</b> |

### 4.2.3.6 5AP1120.101E-000

#### 4.2.3.6.1 General information

- Panel for AP1000, PPC2100, PPC2200 or PPC3100
- 10.1" TFT WXGA color display
- Single-touch (analog resistive)
- Control cabinet installation

#### 4.2.3.6.2 Order data

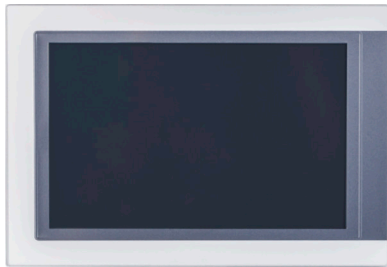
| Order number     | Short description  | Figure  |
|------------------|--|---|
| 5AP1120.101E-000 | Automation Panel 10.1" WXGA TFT - 1280 x 800 pixels (16:10) - Single-touch (analog resistive) - Control cabinet installation - Landscape format - For PPC2100 / PPC3100 / PPC2200 / link modules |  |

#### 4.2.3.6.3 Technical data

### Information:

The following specified characteristic data, features and limit values are only valid for these individual components and may differ from those of the complete system. The data specified for the complete system applies to the complete system in which an individual component is used.

| Order number                       | 5AP1120.101E-000   |
|------------------------------------|--|
| <b>General information</b>         |  |
| B&R ID code                        | 0xE93D   |
| Certifications                     |  |
| CE                                 | Yes  |
| UKCA                               | Yes  |
| UL                                 | cULus E115267<br>Industrial control equipment  |
| HazLoc                             | cULus HazLoc E180196<br>Industrial control equipment<br>for hazardous locations<br>Class I, Division 2, Groups ABCD, T4  |
| <b>Display</b>                     |  |
| Type                               | TFT color  |
| Diagonal                           | 10.1"  |
| Colors                             | 16.7 million   |
| Resolution                         | WXGA, 1280 x 800 pixels  |
| Contrast                           | Hardware revision G0 and later: 700:1<br>Hardware revision F0: 1000:1<br>Hardware revision E0: 700:1<br>Up to hardware revision D0: 1000:1   |
| Viewing angles                     |  |
| Horizontal                         | Direction R = 85° / Direction L = 85°  |
| Vertical                           | Direction U = 85° / Direction D = 85°  |
| <b>Backlight</b>                   |  |
| Type                               | LED  |
| Brightness (dimnable)              | Hardware revision G0 and later: Typ. 25 to 1000 cd/m <sup>2</sup><br>Hardware revision F0: Typ. 25 to 500 cd/m <sup>2</sup><br>Hardware revision E0: Typ. 25 to 1000 cd/m <sup>2</sup><br>Up to hardware revision D0: Typ. 25 to 500 cd/m <sup>2</sup> |
| Half-brightness time <sup>1)</sup> | 50,000 h   |
| <b>Touch screen <sup>2)</sup></b>  |  |
| Technology                         | Analog, resistive  |
| Controller                         | B&R, serial, 12-bit  |
| Transmittance                      | 81% ±3%  |
| <b>Operating conditions</b>        |  |
| Pollution degree per EN 61131-2    | Pollution degree 2   |
| Degree of protection per EN 60529  | Front: IP65<br>Back: IP20 (only with installed link module or installed system unit)   |
| Degree of protection per UL 50     | Front: Type 4X indoor use only   |

|                                  |                         |
|----------------------------------|-------------------------|
| <b>Order number</b>              | <b>5AP1120.101E-000</b> |
| <b>Mechanical properties</b>     |                         |
| Front <sup>3)</sup>              |                         |
| Frame                            | Aluminum, coated        |
| Panel overlay                    |                         |
| Material                         | Polyester               |
| Light background color           | RAL 9006                |
| Dark border color around display | RAL 7024                |
| Gasket                           | 3 mm fixed gasket       |
| Dimensions                       |                         |
| Width                            | 279 mm                  |
| Height                           | 191 mm                  |
| Weight                           | 1900 g                  |

- 1) At 25°C ambient temperature. Reducing the brightness by 50% can increase the half-brightness time by approximately 50%.
- 2) Touch screen drivers for approved operating systems are available for download in the Downloads section of the B&R website ([www.br-automation.com](http://www.br-automation.com)).
- 3) Visual deviations in color and surface quality are possible due to process or batch conditions.

#### 4.2.3.6.4 Dimensions

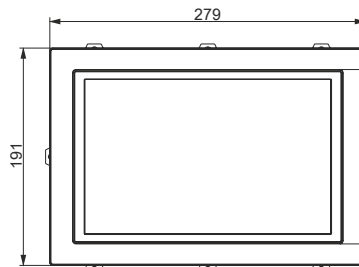

#### 4.2.3.6.5 Temperature/Humidity diagram

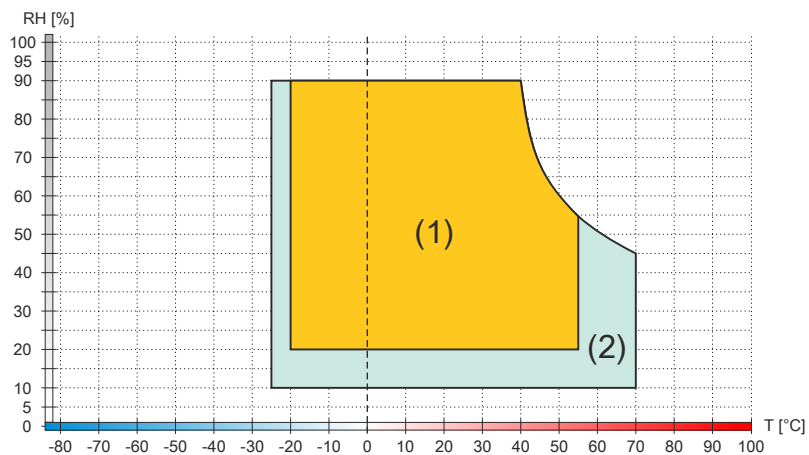

| Diagram legend |                       |        |   |
|----------------|-----------------------|--------|---|
| (1)            | Operation             | T [°C] | Temperature in °C   |
| (2)            | Storage and transport | RH [%] | Relative humidity (RH) in percent and <b>non-condensing</b> |

### 4.2.3.7 5AP1130.101E-000

#### 4.2.3.7.1 General information

- Panel for AP1000, PPC2100, PPC2200 or PPC3100
- 10.1" TFT WXGA color display
- Multi-touch (projected capacitive)
- Control cabinet installation

#### 4.2.3.7.2 Order data

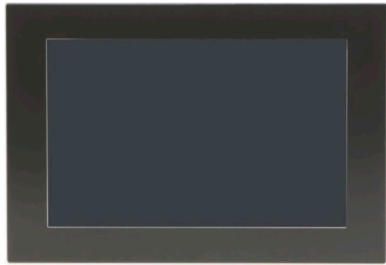
| Order number     | Short description  | Figure  |
|------------------|--|---|
| 5AP1130.101E-000 | <b>Panels</b><br>Automation Panel 10.1" WXGA TFT - 1280 x 800 pixels (16:10)<br>- Multi-touch (projected capacitive) - Control cabinet installation<br>- Landscape format - For PPC2100 / PPC3100 / PPC2200 / link modules |  |

#### 4.2.3.7.3 Technical data

### Information:

The following specified characteristic data, features and limit values are only valid for these individual components and may differ from those of the complete system. The data specified for the complete system applies to the complete system in which an individual component is used.

| Order number                       | 5AP1130.101E-000  |
|------------------------------------|---|
| <b>General information</b>         |   |
| B&R ID code                        | 0xEB62  |
| Certifications                     |   |
| CE                                 | Yes   |
| UKCA                               | Yes   |
| UL                                 | cULus E115267<br>Industrial control equipment   |
| HazLoc                             | cULus HazLoc E180196<br>Industrial control equipment<br>for hazardous locations<br>Class I, Division 2, Groups ABCD, T4                     |
| DNV                                | Temperature: <b>B</b> (0 to 55°C)<br>Humidity: <b>B</b> (up to 100%)<br>Vibration: <b>A</b> (0.7 g)<br>EMC: <b>B</b> (bridge and open deck) |
| LR                                 | ENV3  |
| ABS                                | Yes   |
| BV                                 | <b>EC31B</b><br>Temperature: 5 - 55°C<br>Vibration: 0.7 g<br>EMC: Bridge and open deck  |
| <b>Display</b>                     |   |
| Type                               | TFT color   |
| Diagonal                           | 10.1"   |
| Colors                             | 16.7 million  |
| Resolution                         | WXGA, 1280 x 800 pixels   |
| Contrast                           | Starting with hardware revision I0: 700:1<br>Up to hardware revision H0: 1000:1   |
| Viewing angles                     |   |
| Horizontal                         | Direction R = 85° / Direction L = 85°   |
| Vertical                           | Direction U = 85° / Direction D = 85°   |
| Backlight                          |   |
| Type                               | LED   |
| Brightness (dimnable)              | Starting with hardware revision I0: Typ 25 to 1000 cd/m <sup>2</sup><br>Up to hardware revision H0: Typ. 25 to 500 cd/m <sup>2</sup>        |
| Half-brightness time <sup>1)</sup> | 50,000 h  |
| Touch screen <sup>2)</sup>         |   |
| Technology                         | Projected capacitive touch (PCT)  |
| Transmittance                      | See "Appendix A - Touch screen".  |
| <b>Operating conditions</b>        |   |
| Pollution degree per EN 61131-2    | Pollution degree 2  |

|                                   |  |
|-----------------------------------|--|
| <b>Order number</b>               | <b>5AP1130.101E-000</b>  |
| Degree of protection per EN 60529 | Front: IP65<br>Back: IP20 (only with installed link module or installed system unit) |
| Degree of protection per UL 50    | Front: Type 4X indoor use only   |
| <b>Mechanical properties</b>      |  |
| Front <sup>3)</sup>               |  |
| Frame                             | Aluminum, coated   |
| Design                            | Black  |
| Gasket                            | 3 mm fixed gasket  |
| <b>Dimensions</b>                 |  |
| Width                             | 279 mm   |
| Height                            | 191 mm   |
| Weight                            | 2000 g   |

- 1) At 25°C ambient temperature. Reducing the brightness by 50% can increase the half-brightness time by approximately 50%.
- 2) The specifications for the touch screen driver must be taken into account. See section "Multi-touch drivers" in chapter 4 "Software".
- 3) Visual deviations in color and surface quality are possible due to process or batch conditions.

#### 4.2.3.7.4 Dimensions

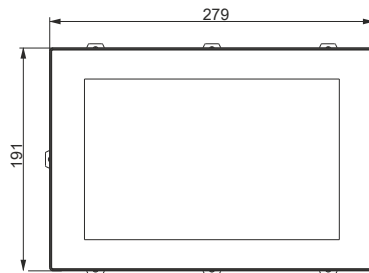

#### 4.2.3.7.5 Temperature/Humidity diagram

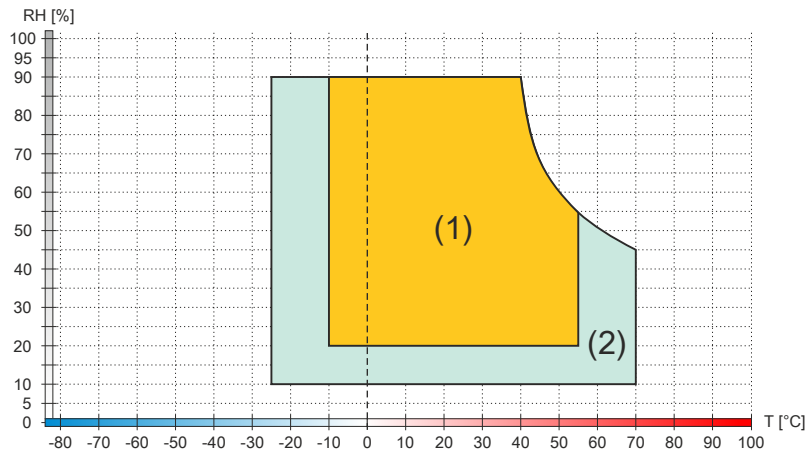

| Diagram legend |                       |        |   |
|----------------|-----------------------|--------|---|
| (1)            | Operation             | T [°C] | Temperature in °C   |
| (2)            | Storage and transport | RH [%] | Relative humidity (RH) in percent and <b>non-condensing</b> |

### 4.2.3.8 5AP1120.1043-000

#### 4.2.3.8.1 General information

- Panel for AP1000, PPC900, PPC2100, PPC2200 or PPC3100
- 10.4" TFT VGA color display
- Single-touch (analog resistive)
- Front USB interface
- Control cabinet installation

#### 4.2.3.8.2 Order data

| Order number     | Short description   | Figure  |
|------------------|---|---|
| 5AP1120.1043-000 | <b>Panels</b><br>Automation Panel 10.4" VGA TFT - 640 x 480 pixels (4:3) - Single-touch (analog resistive) - Control cabinet installation - Landscape format - Front USB - For PPC900/PPC2100/PPC3100/PPC2200 - For link modules - Compatible with 5PP520.1043-00 |  |

#### 4.2.3.8.3 Technical data

### Information:

The following specified characteristic data, features and limit values are only valid for these individual components and may differ from those of the complete system. The data specified for the complete system applies to the complete system in which an individual component is used.

| Order number                       | 5AP1120.1043-000  |
|------------------------------------|---|
| <b>General information</b>         |   |
| B&R ID code                        | 0xE7AD  |
| Certifications                     |   |
| CE                                 | Yes   |
| UKCA                               | Yes   |
| UL                                 | cULus E115267<br>Industrial control equipment   |
| HazLoc                             | cULus HazLoc E180196<br>Industrial control equipment<br>for hazardous locations<br>Class I, Division 2, Groups ABCD, T4 |
| <b>Display</b>                     |   |
| Type                               | TFT color   |
| Diagonal                           | 10.4"   |
| Colors                             | 16.7 million  |
| Resolution                         | VGA, 640 x 480 pixels   |
| Contrast                           | 900:1   |
| Viewing angles                     |   |
| Horizontal                         | Direction R = 80° / Direction L = 80°   |
| Vertical                           | Direction U = 80° / Direction D = 80°   |
| Backlight                          |   |
| Type                               | LED   |
| Brightness (dimnable)              | Typ. 22.5 to 450 cd/m <sup>2</sup>  |
| Half-brightness time <sup>1)</sup> | 70,000 h  |
| Touch screen <sup>2)</sup>         |   |
| Technology                         | Analog, resistive   |
| Controller                         | B&R, serial, 12-bit   |
| Transmittance                      | 81% ±3%   |
| <b>Interfaces</b>                  |   |
| USB                                |   |
| Quantity                           | 1   |
| Type                               | USB 2.0   |
| Variant                            | Type A  |
| Transfer rate                      | Low speed (1.5 Mbit/s), full speed (12 Mbit/s) to high speed (480 Mbit/s)   |
| Current-carrying capacity          | Max. 500 mA   |

|                                   |  |
|-----------------------------------|--|
| <b>Order number</b>               | <b>5AP1120.1043-000</b>  |
| <b>Operating conditions</b>       |  |
| Pollution degree per EN 61131-2   | Pollution degree 2   |
| Degree of protection per EN 60529 | Front: IP65<br>Back: IP20 (only with installed link module or installed system unit) |
| Degree of protection per UL 50    | Front: Type 4X indoor use only   |
| <b>Mechanical properties</b>      |  |
| Front <sup>3)</sup>               |  |
| Frame                             | Aluminum, naturally anodized   |
| Panel overlay                     |  |
| Material                          | Polyester  |
| Light background color            | RAL 9006   |
| Dark border color around display  | RAL 7024   |
| Gasket                            | 3 mm fixed gasket  |
| <b>Dimensions</b>                 |  |
| Width                             | 323 mm   |
| Height                            | 260 mm   |
| Weight                            | 2800 g   |

- 1) At 25°C ambient temperature. Reducing the brightness by 50% can increase the half-brightness time by approximately 50%.
- 2) Touch screen drivers for approved operating systems are available for download in the Downloads section of the B&R website ([www.br-automation.com](http://www.br-automation.com)).
- 3) Visual deviations in color and surface quality are possible due to process or batch conditions.

#### 4.2.3.8.4 Dimensions

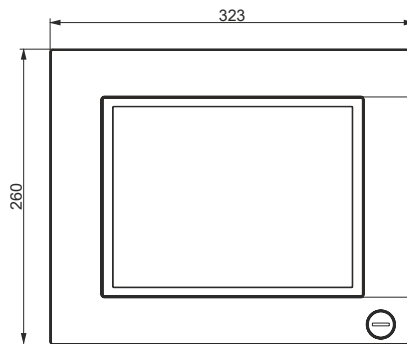

#### 4.2.3.8.5 Requirements

10.4" AP1000 panels are supported starting with the following firmware versions:

- Firmware V03.11 or later with SDL/DVI receiver 5DLSDL.1001-00
- Firmware V04.08 or later with SDL3 receiver 5DLSD3.1001-00
- Firmware V01.03 or later with PPC2100 system unit 5PPC2100.BYxx-000

#### 4.2.3.8.6 Temperature/Humidity diagram

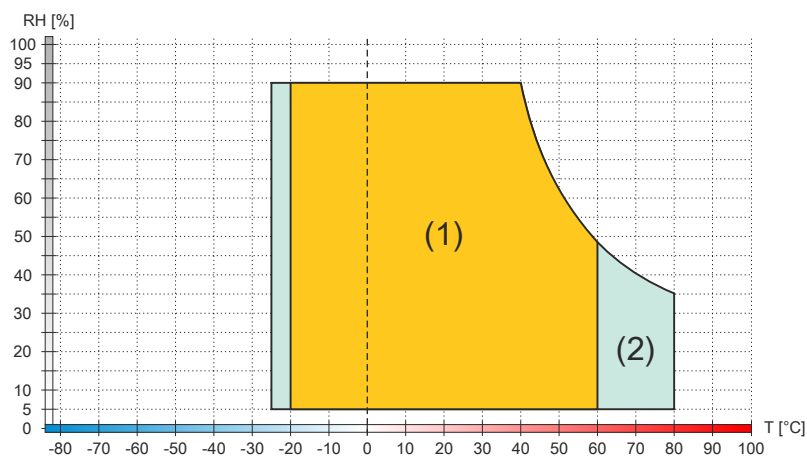

| Diagram legend |                       |        |   |
|----------------|-----------------------|--------|---|
| (1)            | Operation             | T [°C] | Temperature in °C   |
| (2)            | Storage and transport | RH [%] | Relative humidity (RH) in percent and <b>non-condensing</b> |

### 4.2.3.9 5AP1180.1043-000

#### 4.2.3.9.1 General information

- Panel for AP1000, PPC900, PPC2100, PPC2200 or PPC3100
- 10.4" TFT VGA color display
- Single-touch (analog resistive)
- 22 function keys
- Front USB interface
- Control cabinet installation

#### 4.2.3.9.2 Order data

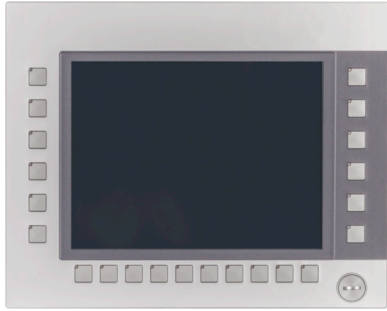
| Order number     | Short description   | Figure  |
|------------------|---|---|
|                  | <b>Panels</b>   |   |
| 5AP1180.1043-000 | Automation Panel 10.4" VGA TFT - 640 x 480 pixels (4:3) - Single-touch (analog resistive) - Control cabinet installation - Landscape format - Front USB - 22 function keys - For PPC900/PPC2100/PPC3100/PPC2200 - For link modules - Compatible with 5PP580.1043-00, 5AP980.1043-01 |  |

#### 4.2.3.9.3 Technical data

### Information:

The following specified characteristic data, features and limit values are only valid for these individual components and may differ from those of the complete system. The data specified for the complete system applies to the complete system in which an individual component is used.

| Order number                       | 5AP1180.1043-000  |
|------------------------------------|---|
| <b>General information</b>         |   |
| B&R ID code                        | 0xE7AE  |
| Certifications                     |   |
| CE                                 | Yes   |
| UKCA                               | Yes   |
| UL                                 | cULus E115267<br>Industrial control equipment   |
| HazLoc                             | cULus HazLoc E180196<br>Industrial control equipment<br>for hazardous locations<br>Class I, Division 2, Groups ABCD, T4 |
| <b>Display</b>                     |   |
| Type                               | TFT color   |
| Diagonal                           | 10.4"   |
| Colors                             | 16.7 million  |
| Resolution                         | VGA, 640 x 480 pixels   |
| Contrast                           | 900:1   |
| Viewing angles                     |   |
| Horizontal                         | Direction R = 80° / Direction L = 80°   |
| Vertical                           | Direction U = 80° / Direction D = 80°   |
| Backlight                          |   |
| Type                               | LED   |
| Brightness (dimnable)              | Typ. 22.5 to 450 cd/m <sup>2</sup>  |
| Half-brightness time <sup>1)</sup> | 70,000 h  |
| Touch screen <sup>2)</sup>         |   |
| Technology                         | Analog, resistive   |
| Controller                         | B&R, serial, 12-bit   |
| Transmittance                      | 81% ±3%   |
| <b>Interfaces</b>                  |   |
| USB                                |   |
| Quantity                           | 1   |
| Type                               | USB 2.0   |
| Variant                            | Type A  |
| Transfer rate                      | Low speed (1.5 Mbit/s), full speed (12 Mbit/s) to high speed (480 Mbit/s)   |
| Current-carrying capacity          | Max. 500 mA   |

|                                   |  |
|-----------------------------------|--|
| <b>Order number</b>               | <b>5AP1180.1043-000</b>  |
| <b>Keys</b>                       |  |
| Function keys                     | 22 with LED (yellow)   |
| System keys                       | No   |
| Service life                      | >1,000,000 actuations at 1 ±0.3 N to 3 ±0.3 N actuating force                        |
| LED luminous intensity            |  |
| Yellow                            | Typ. 38 mcd  |
| <b>Operating conditions</b>       |  |
| Pollution degree per EN 61131-2   | Pollution degree 2   |
| Degree of protection per EN 60529 | Front: IP65<br>Back: IP20 (only with installed link module or installed system unit) |
| Degree of protection per UL 50    | Front: Type 4X indoor use only   |
| <b>Mechanical properties</b>      |  |
| Front <sup>3)</sup>               |  |
| Frame                             | Aluminum, naturally anodized   |
| Panel overlay                     |  |
| Material                          | Polyester  |
| Light background color            | RAL 9006   |
| Dark border color around display  | RAL 7024   |
| Gasket                            | 3 mm fixed gasket  |
| <b>Dimensions</b>                 |  |
| Width                             | 323 mm   |
| Height                            | 260 mm   |
| Weight                            | 2800 g   |

- 1) At 25°C ambient temperature. Reducing the brightness by 50% can increase the half-brightness time by approximately 50%.
- 2) Touch screen drivers for approved operating systems are available for download in the Downloads section of the B&R website ([www.br-automation.com](http://www.br-automation.com)).
- 3) Visual deviations in color and surface quality are possible due to process or batch conditions.

#### 4.2.3.9.4 Dimensions

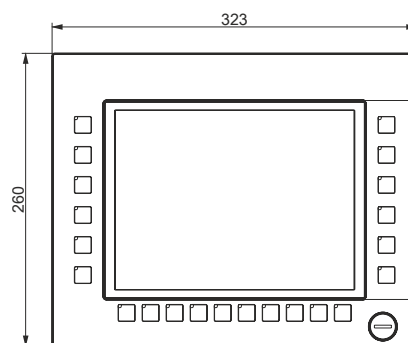

#### 4.2.3.9.5 Requirements

10.4" AP1000 panels are supported starting with the following firmware versions:

- Firmware V03.11 or later with SDL/DVI receiver 5DLSDL.1001-00
- Firmware V04.08 or later with SDL3 receiver 5DLSD3.1001-00
- Firmware V01.03 or later with PPC2100 system unit 5PPC2100.BYxx-000

4.2.3.9.6 Temperature/Humidity diagram

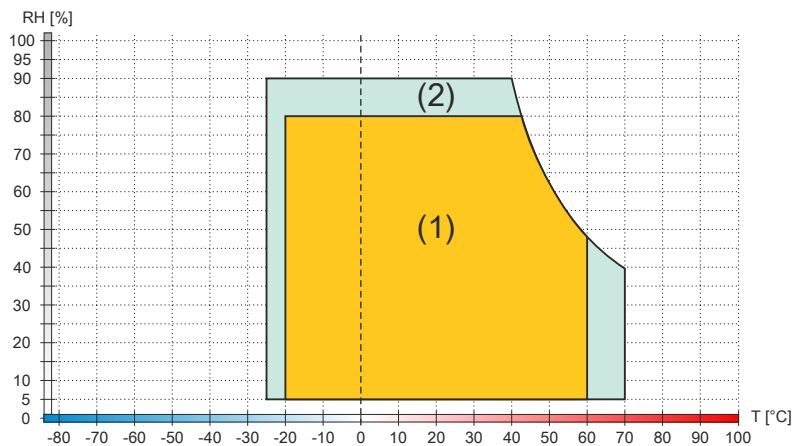

| Diagram legend |                       |        |   |
|----------------|-----------------------|--------|---|
| (1)            | Operation             | T [°C] | Temperature in °C   |
| (2)            | Storage and transport | RH [%] | Relative humidity (RH) in percent and <b>non-condensing</b> |

### 4.2.3.10 5AP1181.1043-000

#### 4.2.3.10.1 General information

- Panel for AP1000, PPC900, PPC2100, PPC2200 or PPC3100
- 10.4" TFT VGA color display
- Single-touch (analog resistive)
- 38 function keys and 20 system keys
- Front USB interface
- Control cabinet installation

#### 4.2.3.10.2 Order data

| Order number     | Short description   | Figure  |
|------------------|---|---|
|                  | <b>Panels</b>   |   |
| 5AP1181.1043-000 | Automation Panel 10.4" VGA TFT - 640 x 480 pixels (4:3) - Single-touch (analog resistive) - Control cabinet installation - Portrait format - Front USB - 38 function keys and 20 system keys - For PPC900/PPC2100/PPC3100/PPC2200 - For link modules - Compatible with 5PP581.1043-00, 5AP981.1043-01, 5PC781.1043-00 |  |

#### 4.2.3.10.3 Technical data

### Information:

The following specified characteristic data, features and limit values are only valid for these individual components and may differ from those of the complete system. The data specified for the complete system applies to the complete system in which an individual component is used.

| Order number                       | 5AP1181.1043-000  |
|------------------------------------|---|
| <b>General information</b>         |   |
| B&R ID code                        | 0xE7AF  |
| Certifications                     |   |
| CE                                 | Yes   |
| UKCA                               | Yes   |
| UL                                 | cULus E115267<br>Industrial control equipment   |
| HazLoc                             | cULus HazLoc E180196<br>Industrial control equipment<br>for hazardous locations<br>Class I, Division 2, Groups ABCD, T4 |
| <b>Display</b>                     |   |
| Type                               | TFT color   |
| Diagonal                           | 10.4"   |
| Colors                             | 16.7 million  |
| Resolution                         | VGA, 640 x 480 pixels   |
| Contrast                           | 900:1   |
| Viewing angles                     |   |
| Horizontal                         | Direction R = 80° / Direction L = 80°   |
| Vertical                           | Direction U = 80° / Direction D = 80°   |
| Backlight                          |   |
| Type                               | LED   |
| Brightness (dimnable)              | Typ. 22.5 to 450 cd/m <sup>2</sup>  |
| Half-brightness time <sup>1)</sup> | 70,000 h  |
| Touch screen <sup>2)</sup>         |   |
| Technology                         | Analog, resistive   |
| Controller                         | B&R, serial, 12-bit   |
| Transmittance                      | 81% ±3%   |

## Technical data

|                                   |  |
|-----------------------------------|--|
| <b>Order number</b>               | <b>5AP1181.1043-000</b>  |
| <b>Interfaces</b>                 |  |
| USB                               |  |
| Quantity                          | 1  |
| Type                              | USB 2.0  |
| Variant                           | Type A   |
| Transfer rate                     | Low speed (1.5 Mbit/s), full speed (12 Mbit/s) to high speed (480 Mbit/s)            |
| Current-carrying capacity         | Max. 500 mA  |
| <b>Keys</b>                       |  |
| Function keys                     | 38 with LED (yellow)   |
| System keys                       | Numeric keys, cursor block   |
| Service life                      | >1,000,000 actuations at 1 ±0.3 N to 3 ±0.3 N actuating force                        |
| LED luminous intensity            |  |
| Yellow                            | Typ. 38 mcd  |
| <b>Operating conditions</b>       |  |
| Pollution degree per EN 61131-2   | Pollution degree 2   |
| Degree of protection per EN 60529 | Front: IP65<br>Back: IP20 (only with installed link module or installed system unit) |
| Degree of protection per UL 50    | Front: Type 4X indoor use only   |
| <b>Mechanical properties</b>      |  |
| Front <sup>3)</sup>               |  |
| Frame                             | Aluminum, naturally anodized   |
| Panel overlay                     |  |
| Material                          | Polyester  |
| Light background color            | RAL 9006   |
| Dark border color around display  | RAL 7024   |
| Gasket                            | 3 mm fixed gasket  |
| Dimensions                        |  |
| Width                             | 323 mm   |
| Height                            | 358 mm   |
| Weight                            | 3400 g   |

- 1) At 25°C ambient temperature. Reducing the brightness by 50% can increase the half-brightness time by approximately 50%.
- 2) Touch screen drivers for approved operating systems are available for download in the Downloads section of the B&R website ([www.br-automation.com](http://www.br-automation.com)).
- 3) Visual deviations in color and surface quality are possible due to process or batch conditions.

### 4.2.3.10.4 Dimensions

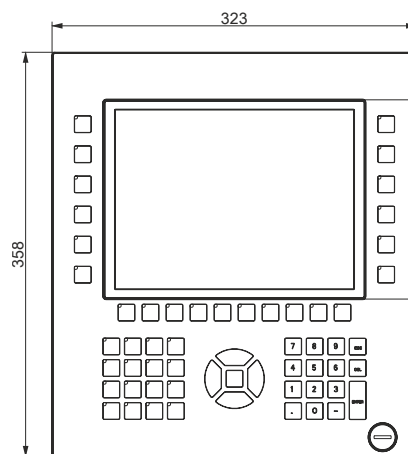

### 4.2.3.10.5 Requirements

10.4" AP1000 panels are supported starting with the following firmware versions:

- Firmware V03.11 or later with SDL/DVI receiver 5DLSDL.1001-00
- Firmware V04.08 or later with SDL3 receiver 5DLSD3.1001-00
- Firmware V01.03 or later with PPC2100 system unit 5PPC2100.BYxx-000

4.2.3.10.6 Temperature/Humidity diagram

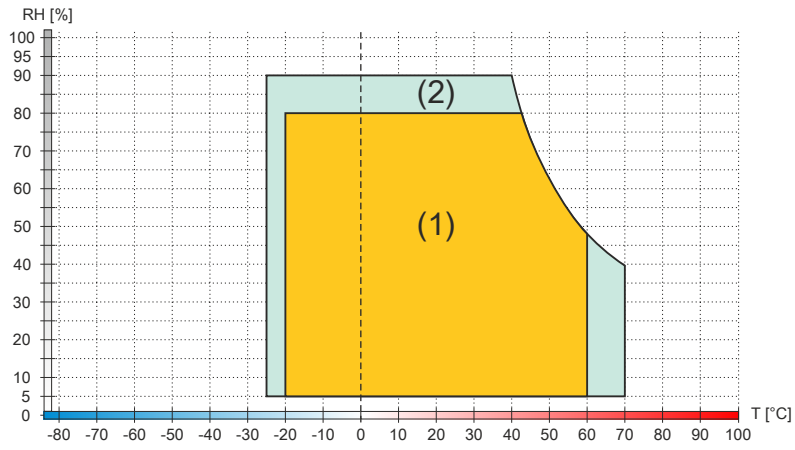

| Diagram legend |                       |        |   |
|----------------|-----------------------|--------|---|
| (1)            | Operation             | T [°C] | Temperature in °C   |
| (2)            | Storage and transport | RH [%] | Relative humidity (RH) in percent and <b>non-condensing</b> |

### 4.2.3.11 5AP1182.1043-000

#### 4.2.3.11.1 General information

- Panel for AP1000, PPC900, PPC2100, PPC2200 or PPC3100
- 10.4" TFT VGA color display
- Single-touch (analog resistive)
- 44 function keys and 20 system keys
- Front USB interface
- Control cabinet installation

#### 4.2.3.11.2 Order data

| Order number     | Short description  | Figure  |
|------------------|--|---|
|                  | <b>Panels</b>  |   |
| 5AP1182.1043-000 | Automation Panel 10.4" VGA TFT - 640 x 480 pixels (4:3) - Single-touch (analog resistive) - Control cabinet installation - Landscape format - Front USB - 44 function keys and 20 system keys - For PPC900/PPC2100/PPC3100/PPC2200 - For link modules - Compatible with 5PP582.1043-00, 5AP982.1043-01, 5PC782.1043-00 |  |

#### 4.2.3.11.3 Technical data

### Information:

The following specified characteristic data, features and limit values are only valid for these individual components and may differ from those of the complete system. The data specified for the complete system applies to the complete system in which an individual component is used.

| Order number                       | 5AP1182.1043-000  |
|------------------------------------|---|
| <b>General information</b>         |   |
| B&R ID code                        | 0xE7B0  |
| Certifications                     |   |
| CE                                 | Yes   |
| UKCA                               | Yes   |
| UL                                 | cULus E115267<br>Industrial control equipment   |
| HazLoc                             | cULus HazLoc E180196<br>Industrial control equipment<br>for hazardous locations<br>Class I, Division 2, Groups ABCD, T4 |
| <b>Display</b>                     |   |
| Type                               | TFT color   |
| Diagonal                           | 10.4"   |
| Colors                             | 16.7 million  |
| Resolution                         | VGA, 640 x 480 pixels   |
| Contrast                           | 900:1   |
| Viewing angles                     |   |
| Horizontal                         | Direction R = 80° / Direction L = 80°   |
| Vertical                           | Direction U = 80° / Direction D = 80°   |
| Backlight                          |   |
| Type                               | LED   |
| Brightness (dimnable)              | Typ. 22.5 to 450 cd/m <sup>2</sup>  |
| Half-brightness time <sup>1)</sup> | 70,000 h  |
| Touch screen <sup>2)</sup>         |   |
| Technology                         | Analog, resistive   |
| Controller                         | B&R, serial, 12-bit   |
| Transmittance                      | 81% ±3%   |
| <b>Interfaces</b>                  |   |
| USB                                |   |
| Quantity                           | 1   |
| Type                               | USB 2.0   |
| Variant                            | Type A  |
| Transfer rate                      | Low speed (1.5 Mbit/s), full speed (12 Mbit/s) to high speed (480 Mbit/s)   |
| Current-carrying capacity          | Max. 500 mA   |
| <b>Keys</b>                        |   |
| Function keys                      | 44 with LED (yellow)  |

|                                   |  |
|-----------------------------------|--|
| <b>Order number</b>               | <b>5AP1182.1043-000</b>  |
| System keys                       | Numeric keys, cursor block   |
| Service life                      | >1,000,000 actuations at 1 ±0.3 N to 3 ±0.3 N actuating force                        |
| LED luminous intensity            |  |
| Yellow                            | Typ. 38 mcd  |
| <b>Operating conditions</b>       |  |
| Pollution degree per EN 61131-2   | Pollution degree 2   |
| Degree of protection per EN 60529 | Front: IP65<br>Back: IP20 (only with installed link module or installed system unit) |
| Degree of protection per UL 50    | Front: Type 4X indoor use only   |
| <b>Mechanical properties</b>      |  |
| Front <sup>3)</sup>               |  |
| Frame                             | Aluminum, naturally anodized   |
| Panel overlay                     |  |
| Material                          | Polyester  |
| Light background color            | RAL 9006   |
| Dark border color around display  | RAL 7024   |
| Gasket                            | 3 mm fixed gasket  |
| Dimensions                        |  |
| Width                             | 423 mm   |
| Height                            | 288 mm   |
| Weight                            | 3500 g   |

- 1) At 25°C ambient temperature. Reducing the brightness by 50% can increase the half-brightness time by approximately 50%.
- 2) Touch screen drivers for approved operating systems are available for download in the Downloads section of the B&R website ([www.br-automation.com](http://www.br-automation.com)).
- 3) Visual deviations in color and surface quality are possible due to process or batch conditions.

#### 4.2.3.11.4 Dimensions

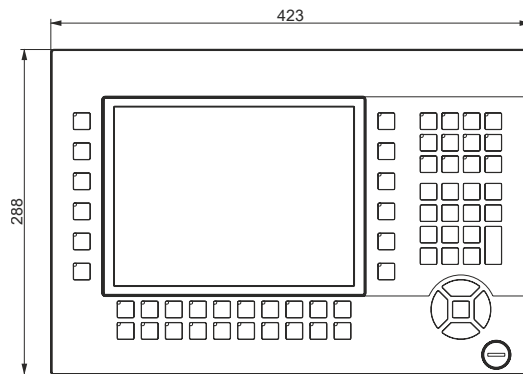

#### 4.2.3.11.5 Requirements

10.4" AP1000 panels are supported starting with the following firmware versions:

- Firmware V03.11 or later with SDL/DVI receiver 5DLSDL.1001-00
- Firmware V04.08 or later with SDL3 receiver 5DLSD3.1001-00
- Firmware V01.03 or later with PPC2100 system unit 5PPC2100.BYxx-000

### 4.2.3.11.6 Temperature/Humidity diagram

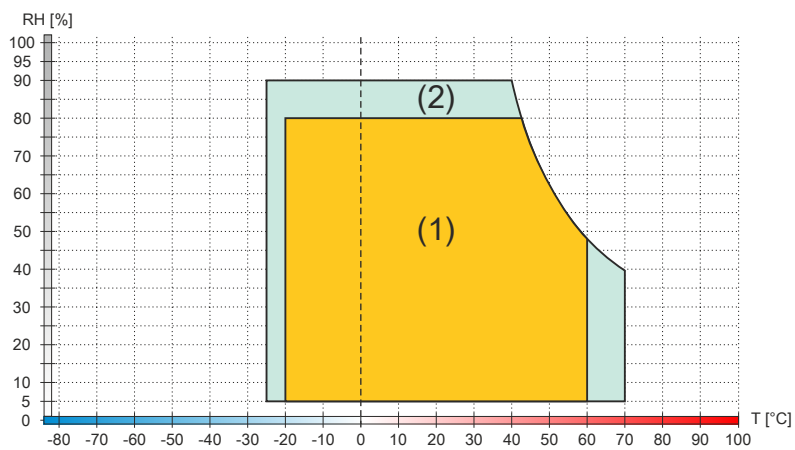

| Diagram legend |                       |        |   |
|----------------|-----------------------|--------|---|
| (1)            | Operation             | T [°C] | Temperature in °C   |
| (2)            | Storage and transport | RH [%] | Relative humidity (RH) in percent and <b>non-condensing</b> |

### 4.2.3.12 5AP1120.1214-000

#### 4.2.3.12.1 General information

- Panel for AP1000, PPC900, PPC2100, PPC2200 or PPC3100
- 12.1" TFT SVGA color display
- Single-touch (analog resistive)
- Front USB interface
- Control cabinet installation

#### 4.2.3.12.2 Order data

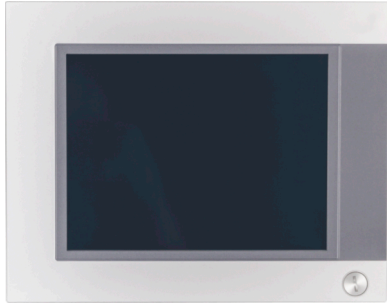
| Order number     | Short description  | Figure  |
|------------------|--|---|
| 5AP1120.1214-000 | <b>Panels</b><br>Automation Panel 12.1" SVGA TFT - 800 x 600 pixels (4:3) - Single-touch (analog resistive) - Control cabinet installation - Landscape format - Front USB - For PPC900/PPC2100/PPC3100/PPC2200 - For link modules - Compatible with 5PP520.1214-00 |  |

#### 4.2.3.12.3 Technical data

### Information:

The following specified characteristic data, features and limit values are only valid for these individual components and may differ from those of the complete system. The data specified for the complete system applies to the complete system in which an individual component is used.

| Order number                       | 5AP1120.1214-000  |
|------------------------------------|---|
| <b>General information</b>         |   |
| B&R ID code                        | 0xE7BB  |
| Certifications                     |   |
| CE                                 | Yes   |
| UKCA                               | Yes   |
| UL                                 | cULus E115267<br>Industrial control equipment   |
| HazLoc                             | cULus HazLoc E180196<br>Industrial control equipment<br>for hazardous locations<br>Class I, Division 2, Groups ABCD, T4 |
| <b>Display</b>                     |   |
| Type                               | TFT color   |
| Diagonal                           | 12.1"   |
| Colors                             | 16.7 million  |
| Resolution                         | SVGA, 800 x 600 pixels  |
| Contrast                           | 1500:1  |
| Viewing angles                     |   |
| Horizontal                         | Direction R = 89° / Direction L = 89°   |
| Vertical                           | Direction U = 89° / Direction D = 89°   |
| Backlight                          |   |
| Type                               | LED   |
| Brightness (dimnable)              | Typ. 22.5 to 450 cd/m <sup>2</sup>  |
| Half-brightness time <sup>1)</sup> | 50,000 h  |
| Touch screen <sup>2)</sup>         |   |
| Technology                         | Analog, resistive   |
| Controller                         | B&R, serial, 12-bit   |
| Transmittance                      | 81% ±3%   |
| <b>Interfaces</b>                  |   |
| USB                                |   |
| Quantity                           | 1   |
| Type                               | USB 2.0   |
| Variant                            | Type A  |
| Transfer rate                      | Low speed (1.5 Mbit/s), full speed (12 Mbit/s) to high speed (480 Mbit/s)   |
| Current-carrying capacity          | Max. 500 mA   |

## Technical data

|                                   |  |
|-----------------------------------|--|
| <b>Order number</b>               | <b>5AP1120.1214-000</b>  |
| <b>Operating conditions</b>       |  |
| Pollution degree per EN 61131-2   | Pollution degree 2   |
| Degree of protection per EN 60529 | Front: IP65<br>Back: IP20 (only with installed link module or installed system unit) |
| Degree of protection per UL 50    | Front: Type 4X indoor use only   |
| <b>Mechanical properties</b>      |  |
| Front <sup>3)</sup>               |  |
| Frame                             | Aluminum, naturally anodized   |
| Panel overlay                     |  |
| Material                          | Polyester  |
| Light background color            | RAL 9006   |
| Dark border color around display  | RAL 7024   |
| Gasket                            | 3 mm fixed gasket  |
| <b>Dimensions</b>                 |  |
| Width                             | 362 mm   |
| Height                            | 284 mm   |
| Weight                            | 3200 g   |

- 1) At 25°C ambient temperature. Reducing the brightness by 50% can increase the half-brightness time by approximately 50%.
- 2) Touch screen drivers for approved operating systems are available for download in the Downloads section of the B&R website ([www.br-automation.com](http://www.br-automation.com)).
- 3) Visual deviations in color and surface quality are possible due to process or batch conditions.

### 4.2.3.12.4 Dimensions

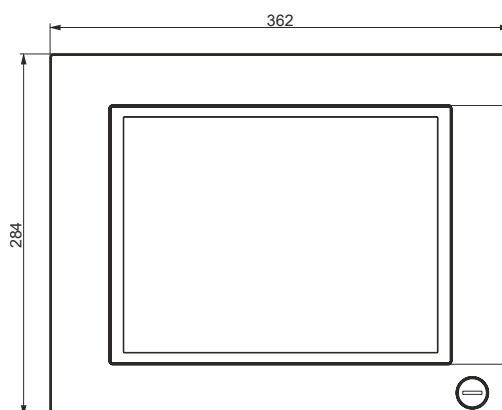

### 4.2.3.12.5 Temperature/Humidity diagram

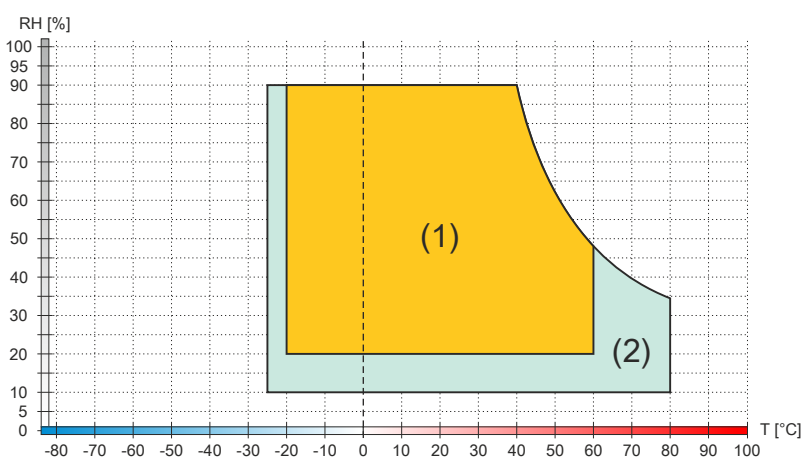

| Diagram legend |                       |        |   |
|----------------|-----------------------|--------|---|
| (1)            | Operation             | T [°C] | Temperature in °C   |
| (2)            | Storage and transport | RH [%] | Relative humidity (RH) in percent and <b>non-condensing</b> |

### 4.2.3.13 5AP1120.121E-000

#### 4.2.3.13.1 General information

- Panel for AP1000, PPC2100, PPC2200 or PPC3100
- 12.1" TFT WXGA color display
- Single-touch (analog resistive)
- Control cabinet installation

#### 4.2.3.13.2 Order data

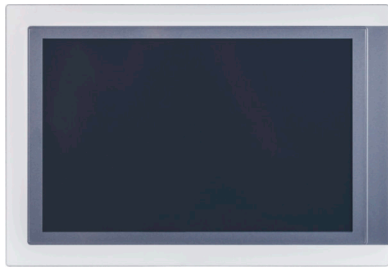
| Order number     | Short description  | Figure  |
|------------------|--|---|
| 5AP1120.121E-000 | Automation Panel 12.1" WXGA TFT - 1280 x 800 pixels (16:10) - Single-touch (analog resistive) - Control cabinet installation - Landscape format - For PPC2100 / PPC3100 / PPC2200 / link modules |  |

#### 4.2.3.13.3 Technical data

### Information:

The following specified characteristic data, features and limit values are only valid for these individual components and may differ from those of the complete system. The data specified for the complete system applies to the complete system in which an individual component is used.

| Order number                       | 5AP1120.121E-000  |
|------------------------------------|---|
| <b>General information</b>         |   |
| B&R ID code                        | 0xE8E4  |
| Certifications                     |   |
| CE                                 | Yes   |
| UKCA                               | Yes   |
| UL                                 | cULus E115267<br>Industrial control equipment   |
| HazLoc                             | cULus HazLoc E180196<br>Industrial control equipment<br>for hazardous locations<br>Class I, Division 2, Groups ABCD, T4 |
| <b>Display</b>                     |   |
| Type                               | TFT color   |
| Diagonal                           | 12.1"   |
| Colors                             | 16.7 million  |
| Resolution                         | WXGA, 1280 x 800 pixels   |
| Contrast                           | 900:1   |
| Viewing angles                     |   |
| Horizontal                         | Direction R = 80° / Direction L = 80°   |
| Vertical                           | Direction U = 65° / Direction D = 80°   |
| Backlight                          |   |
| Type                               | LED   |
| Brightness (dimnable)              | Typ. 40 to 400 cd/m <sup>2</sup>  |
| Half-brightness time <sup>1)</sup> | 50,000 h  |
| Touch screen <sup>2)</sup>         |   |
| Technology                         | Analog, resistive   |
| Controller                         | B&R, serial, 12-bit   |
| Transmittance                      | 81% ±3%   |
| <b>Operating conditions</b>        |   |
| Pollution degree per EN 61131-2    | Pollution degree 2  |
| Degree of protection per EN 60529  | Front: IP65<br>Back: IP20 (only with installed link module or installed system unit)                                    |
| Degree of protection per UL 50     | Front: Type 4X indoor use only  |

## Technical data

|                                  |                         |
|----------------------------------|-------------------------|
| <b>Order number</b>              | <b>5AP1120.121E-000</b> |
| <b>Mechanical properties</b>     |                         |
| Front <sup>3)</sup>              |                         |
| Frame                            | Aluminum, coated        |
| Panel overlay                    |                         |
| Material                         | Polyester               |
| Light background color           | RAL 9006                |
| Dark border color around display | RAL 7024                |
| Gasket                           | 3 mm fixed gasket       |
| <b>Dimensions</b>                |                         |
| Width                            | 324 mm                  |
| Height                           | 221.5 mm                |
| Weight                           | 2300 g                  |

- 1) At 25°C ambient temperature. Reducing the brightness by 50% can increase the half-brightness time by approximately 50%.
- 2) Touch screen drivers for approved operating systems are available for download in the Downloads section of the B&R website ([www.br-automation.com](http://www.br-automation.com)).
- 3) Visual deviations in color and surface quality are possible due to process or batch conditions.

### 4.2.3.13.4 Dimensions

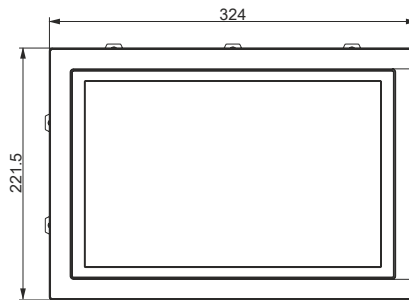

### 4.2.3.13.5 Temperature/Humidity diagram

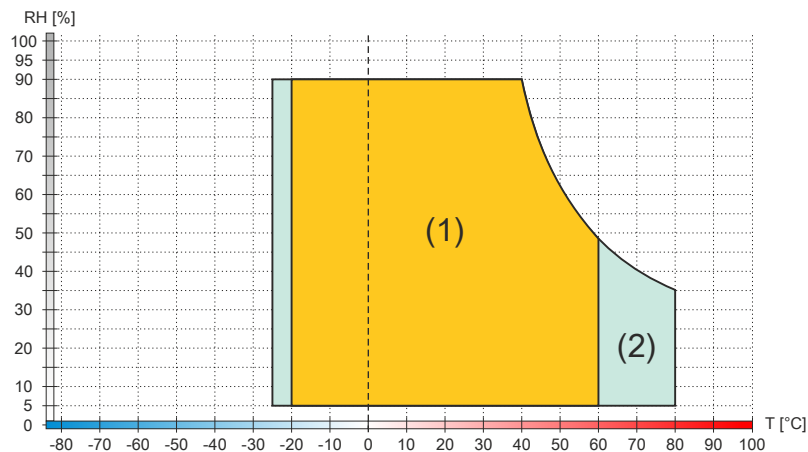

| Diagram legend |                       |        |   |
|----------------|-----------------------|--------|---|
| (1)            | Operation             | T [°C] | Temperature in °C   |
| (2)            | Storage and transport | RH [%] | Relative humidity (RH) in percent and <b>non-condensing</b> |

4.2.3.14 5AP1130.121E-000

4.2.3.14.1 General information

- Panel for AP1000, PPC2100, PPC2200 or PPC3100
- 12.1" TFT WXGA color display
- Multi-touch (projected capacitive)
- Control cabinet installation

4.2.3.14.2 Order data

| Order number     | Short description  | Figure  |
|------------------|--|---|
| 5AP1130.121E-000 | <b>Panels</b><br>Automation Panel 12.1" WXGA TFT - 1280 x 800 pixels (16:10)<br>- Multi-touch (projected capacitive) - Control cabinet installation<br>- Landscape format - For PPC2100 / PPC3100 / PPC2200 / link modules |  |

4.2.3.14.3 Technical data

**Information:**

The following specified characteristic data, features and limit values are only valid for these individual components and may differ from those of the complete system. The data specified for the complete system applies to the complete system in which an individual component is used.

| Order number                       | 5AP1130.121E-000  |
|------------------------------------|---|
| <b>General information</b>         |   |
| B&R ID code                        | 0xEB63  |
| Certifications                     |   |
| CE                                 | Yes   |
| UKCA                               | Yes   |
| UL                                 | cULus E115267<br>Industrial control equipment   |
| HazLoc                             | cULus HazLoc E180196<br>Industrial control equipment<br>for hazardous locations<br>Class I, Division 2, Groups ABCD, T4 |
| <b>Display</b>                     |   |
| Type                               | TFT color   |
| Diagonal                           | 12.1"   |
| Colors                             | 16.7 million  |
| Resolution                         | WXGA, 1280 x 800 pixels   |
| Contrast                           | 900:1   |
| Viewing angles                     |   |
| Horizontal                         | Direction R = 80° / Direction L = 80°   |
| Vertical                           | Direction U = 65° / Direction D = 80°   |
| Backlight                          |   |
| Type                               | LED   |
| Brightness (dimnable)              | Typ. 40 to 400 cd/m <sup>2</sup>  |
| Half-brightness time <sup>1)</sup> | 50,000 h  |
| Touch screen <sup>2)</sup>         |   |
| Technology                         | Projected capacitive touch (PCT)  |
| Transmittance                      | See "Appendix A - Touch screen".  |
| <b>Operating conditions</b>        |   |
| Pollution degree per EN 61131-2    | Pollution degree 2  |
| Degree of protection per EN 60529  | Front: IP65<br>Back: IP20 (only with installed link module or installed system unit)                                    |
| Degree of protection per UL 50     | Front: Type 4X indoor use only  |
| <b>Mechanical properties</b>       |   |
| Front <sup>3)</sup>                |   |
| Frame                              | Aluminum, coated  |
| Design                             | Black   |
| Gasket                             | 3 mm fixed gasket   |

## Technical data

|                     |                         |
|---------------------|-------------------------|
| <b>Order number</b> | <b>5AP1130.121E-000</b> |
| Dimensions          |                         |
| Width               | 324 mm                  |
| Height              | 221.5 mm                |
| Weight              | 2400 g                  |

- 1) At 25°C ambient temperature. Reducing the brightness by 50% can increase the half-brightness time by approximately 50%.
- 2) The specifications for the touch screen driver must be taken into account. See section "Multi-touch drivers" in chapter 4 "Software".
- 3) Visual deviations in color and surface quality are possible due to process or batch conditions.

### 4.2.3.14.4 Dimensions

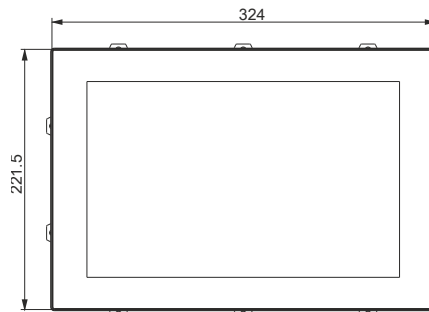

### 4.2.3.14.5 Temperature/Humidity diagram

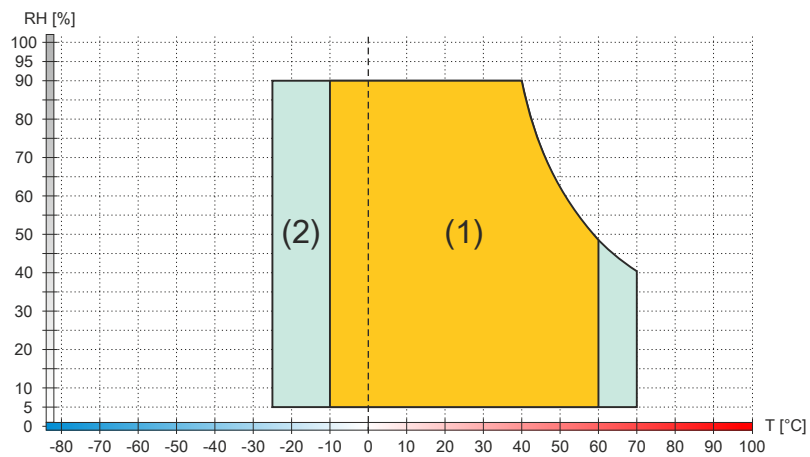

| Diagram legend |                       |        |   |
|----------------|-----------------------|--------|---|
| (1)            | Operation             | T [°C] | Temperature in °C   |
| (2)            | Storage and transport | RH [%] | Relative humidity (RH) in percent and <b>non-condensing</b> |

### 4.2.3.15 5AP1130.121E-010

#### 4.2.3.15.1 General information

- Panel for AP1000, PPC2100, PPC2200 or PPC3100
- 12.1" TFT WXGA color display
- Multi-touch (projected capacitive)
- Sunlight-readable display

#### 4.2.3.15.2 Order data

| Order number     | Short description  | Figure  |
|------------------|--|---|
| 5AP1130.121E-010 | Automation Panel 12.1" sunlight readable - 1280 x 800 pixels (16:10) - Multi-touch (projected capacitive) - Control cabinet installation - Landscape format - For PPC2100/PPC3100/PPC2200 - For link modules |  |

#### 4.2.3.15.3 Technical data

### Information:

The following specified characteristic data, features and limit values are only valid for these individual components and may differ from those of the complete system. The data specified for the complete system applies to the complete system in which an individual component is used.

| Order number                       | 5AP1130.121E-010  |
|------------------------------------|---|
| <b>General information</b>         |   |
| B&R ID code                        | 0x27D9  |
| Certifications                     |   |
| CE                                 | Yes   |
| UKCA                               | Yes   |
| UL                                 | cULus E115267<br>Industrial control equipment   |
| HazLoc                             | cULus HazLoc E180196<br>Industrial control equipment<br>for hazardous locations<br>Class I, Division 2, Groups ABCD, T4 |
| <b>Display</b>                     |   |
| Type                               | TFT color   |
| Diagonal                           | 12.1"   |
| Colors                             | 16.7 million  |
| Resolution                         | WXGA, 1280 x 800 pixels   |
| Contrast                           | 1000:1  |
| Sunlight readable                  | Yes   |
| Air bonding                        | Yes   |
| Viewing angles                     |   |
| Horizontal                         | Direction R = 89° / Direction L = 89°   |
| Vertical                           | Direction U = 89° / Direction D = 89°   |
| Backlight                          |   |
| Type                               | LED   |
| Brightness (dimnable)              | Typ. 150 to 1500 cd/m <sup>2</sup>  |
| Half-brightness time <sup>1)</sup> | 70,000 h  |
| Touch screen <sup>2)</sup>         |   |
| Technology                         | Projected capacitive touch (PCT)  |
| Transmittance                      | See "Appendix A - Touch screen".  |
| <b>Operating conditions</b>        |   |
| Pollution degree per EN 61131-2    | Pollution degree 2  |
| Degree of protection per EN 60529  | Front: IP65<br>Back: IP20 (only with installed link module or installed system unit)                                    |
| Degree of protection per UL 50     | Front: Type 4X indoor use only  |
| <b>Mechanical properties</b>       |   |
| Front <sup>3)</sup>                |   |
| Frame                              | Aluminum, coated  |
| Design                             | Black   |
| Gasket                             | 3 mm fixed gasket   |

## Technical data

|                     |                         |
|---------------------|-------------------------|
| <b>Order number</b> | <b>5AP1130.121E-010</b> |
| Dimensions          |                         |
| Width               | 324 mm                  |
| Height              | 221.5 mm                |
| Weight              | Approx. 2900 g          |

- 1) At 25°C ambient temperature. Reducing the brightness by 50% can increase the half-brightness time by approximately 50%.
- 2) The specifications for the touch screen driver must be taken into account. See section "Multi-touch drivers" in chapter 4 "Software".
- 3) Visual deviations in color and surface quality are possible due to process or batch conditions.

### 4.2.3.15.4 Dimensions

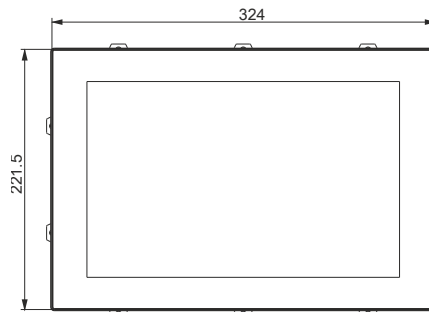

### 4.2.3.15.5 Temperature/Humidity diagram

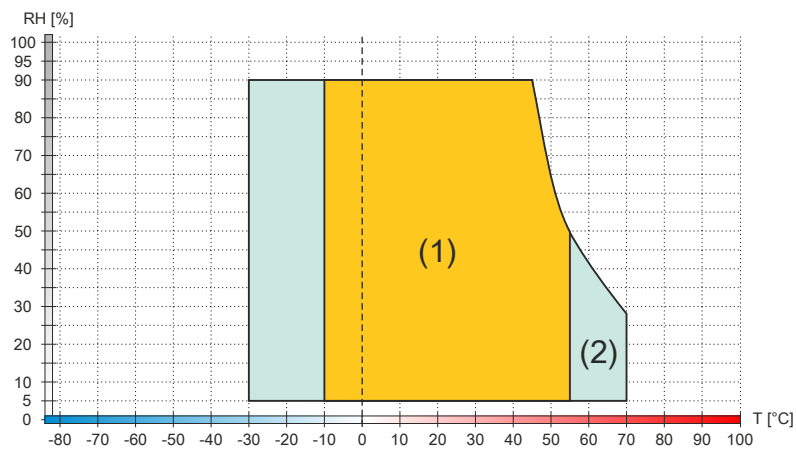

#### Diagram legend

|     |                       |        |   |
|-----|-----------------------|--------|---|
| (1) | Operation             | T [°C] | Temperature in °C   |
| (2) | Storage and transport | RH [%] | Relative humidity (RH) in percent and <b>non-condensing</b> |

### 4.2.3.16 5AP1120.1505-000

#### 4.2.3.16.1 General information

- Panel for AP1000, PPC900, PPC2100, PPC2200 or PPC3100
- 15.0" TFT XGA color display
- Single-touch (analog resistive)
- Front USB interface
- Control cabinet installation

#### 4.2.3.16.2 Order data

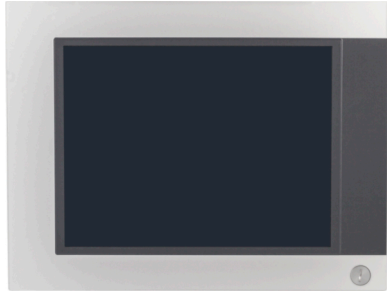
| Order number     | Short description  | Figure  |
|------------------|--|---|
| 5AP1120.1505-000 | <b>Panels</b><br>Automation Panel 15.0" XGA TFT - 1024 x 768 pixels (4:3) - Single-touch (analog resistive) - Control cabinet installation - Landscape format - Front USB - For PPC900/PPC2100/PPC3100/PPC2200 - For link modules - Compatible with 5PP520.1505-00, 5AP920.1505-01, 5PC720.1505-xx, 5PC820.1505-00 |  |

#### 4.2.3.16.3 Technical data

### Information:

The following specified characteristic data, features and limit values are only valid for these individual components and may differ from those of the complete system. The data specified for the complete system applies to the complete system in which an individual component is used.

| Order number                       | 5AP1120.1505-000  |
|------------------------------------|---|
| <b>General information</b>         |   |
| B&R ID code                        | 0xE7BC  |
| Certifications                     |   |
| CE                                 | Yes   |
| UKCA                               | Yes   |
| UL                                 | cULus E115267<br>Industrial control equipment   |
| HazLoc                             | cULus HazLoc E180196<br>Industrial control equipment<br>for hazardous locations<br>Class I, Division 2, Groups ABCD, T4 |
| <b>Display</b>                     |   |
| Type                               | TFT color   |
| Diagonal                           | 15.0"   |
| Colors                             | 16.7 million  |
| Resolution                         | XGA, 1024 x 768 pixels  |
| Contrast                           | 700:1   |
| Viewing angles                     |   |
| Horizontal                         | Direction R = 80° / Direction L = 80°   |
| Vertical                           | Direction U = 70° / Direction D = 70°   |
| Backlight                          |   |
| Type                               | LED   |
| Brightness (dimnable)              | Typ. 20 to 400 cd/m <sup>2</sup>  |
| Half-brightness time <sup>1)</sup> | 50,000 h  |
| Touch screen <sup>2)</sup>         |   |
| Technology                         | Analog, resistive   |
| Controller                         | B&R, serial, 12-bit   |
| Transmittance                      | 81% ±3%   |
| <b>Interfaces</b>                  |   |
| USB                                |   |
| Quantity                           | 1   |
| Type                               | USB 2.0   |
| Variant                            | Type A  |
| Transfer rate                      | Low speed (1.5 Mbit/s), full speed (12 Mbit/s) to high speed (480 Mbit/s)   |
| Current-carrying capacity          | Max. 500 mA   |
| <b>Operating conditions</b>        |   |
| Pollution degree per EN 61131-2    | Pollution degree 2  |

## Technical data

|                                   |  |
|-----------------------------------|--|
| <b>Order number</b>               | <b>5AP1120.1505-000</b>  |
| Degree of protection per EN 60529 | Front: IP65<br>Back: IP20 (only with installed link module or installed system unit) |
| Degree of protection per UL 50    | Front: Type 4X indoor use only   |
| <b>Mechanical properties</b>      |  |
| Front <sup>3)</sup>               |  |
| Frame                             | Aluminum, naturally anodized   |
| Panel overlay                     |  |
| Material                          | Polyester  |
| Light background color            | RAL 9006   |
| Dark border color around display  | RAL 7024   |
| Gasket                            | 3 mm fixed gasket  |
| <b>Dimensions</b>                 |  |
| Width                             | 435 mm   |
| Height                            | 330 mm   |
| Weight                            | 5000 g   |

- 1) At 25°C ambient temperature. Reducing the brightness by 50% can increase the half-brightness time by approximately 50%.
- 2) Touch screen drivers for approved operating systems are available for download in the Downloads section of the B&R website ([www.br-automation.com](http://www.br-automation.com)).
- 3) Visual deviations in color and surface quality are possible due to process or batch conditions.

### 4.2.3.16.4 Dimensions

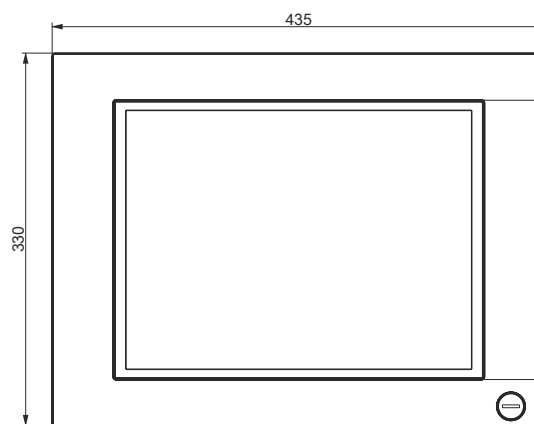

### 4.2.3.16.5 Temperature/Humidity diagram

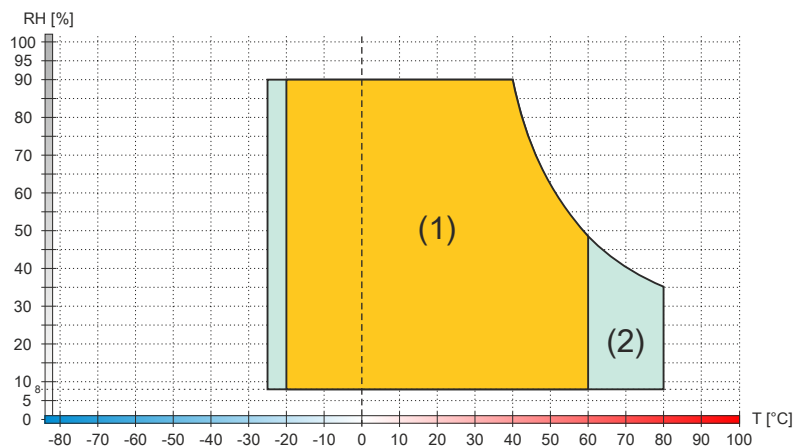

| Diagram legend |                       |        |   |
|----------------|-----------------------|--------|---|
| (1)            | Operation             | T [°C] | Temperature in °C   |
| (2)            | Storage and transport | RH [%] | Relative humidity (RH) in percent and <b>non-condensing</b> |

### 4.2.3.17 5AP1180.1505-000

#### 4.2.3.17.1 General information

- Panel for AP1000, PPC900, PPC2100, PPC2200 or PPC3100
- 15.0" TFT XGA color display
- Single-touch (analog resistive)
- 32 function keys
- Front USB interface
- Control cabinet installation

#### 4.2.3.17.2 Order data

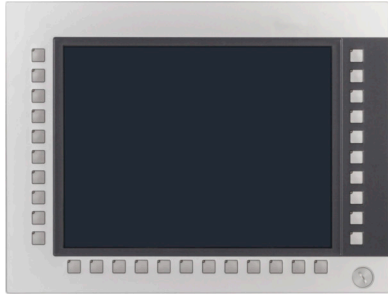
| Order number     | Short description  | Figure  |
|------------------|--|---|
|                  | <b>Panels</b>  |   |
| 5AP1180.1505-000 | Automation Panel 15.0" XGA TFT - 1024 x 768 pixels (4:3) - Single-touch (analog resistive) - Control cabinet installation - Landscape format - Front USB - 32 function keys - For PPC900/PPC2100/PPC3100/PPC2200 - For link modules - Compatible with 5PP580.1505-00, 5AP980.1505-01 |  |

#### 4.2.3.17.3 Technical data

### Information:

The following specified characteristic data, features and limit values are only valid for these individual components and may differ from those of the complete system. The data specified for the complete system applies to the complete system in which an individual component is used.

| Order number                       | 5AP1180.1505-000  |
|------------------------------------|---|
| <b>General information</b>         |   |
| B&R ID code                        | 0xE7BD  |
| Certifications                     |   |
| CE                                 | Yes   |
| UKCA                               | Yes   |
| UL                                 | cULus E115267<br>Industrial control equipment   |
| HazLoc                             | cULus HazLoc E180196<br>Industrial control equipment<br>for hazardous locations<br>Class I, Division 2, Groups ABCD, T4 |
| <b>Display</b>                     |   |
| Type                               | TFT color   |
| Diagonal                           | 15.0"   |
| Colors                             | 16.7 million  |
| Resolution                         | XGA, 1024 x 768 pixels  |
| Contrast                           | 700:1   |
| Viewing angles                     |   |
| Horizontal                         | Direction R = 80° / Direction L = 80°   |
| Vertical                           | Direction U = 70° / Direction D = 70°   |
| Backlight                          |   |
| Type                               | LED   |
| Brightness (dimnable)              | Typ. 20 to 400 cd/m <sup>2</sup>  |
| Half-brightness time <sup>1)</sup> | 50,000 h  |
| Touch screen <sup>2)</sup>         |   |
| Technology                         | Analog, resistive   |
| Controller                         | B&R, serial, 12-bit   |
| Transmittance                      | 81% ±3%   |
| <b>Interfaces</b>                  |   |
| USB                                |   |
| Quantity                           | 1   |
| Type                               | USB 2.0   |
| Variant                            | Type A  |
| Transfer rate                      | Low speed (1.5 Mbit/s), full speed (12 Mbit/s) to high speed (480 Mbit/s)   |
| Current-carrying capacity          | Max. 500 mA   |

## Technical data

|                                   |  |
|-----------------------------------|--|
| <b>Order number</b>               | <b>5AP1180.1505-000</b>  |
| <b>Keys</b>                       |  |
| Function keys                     | 32 with LED (yellow)   |
| System keys                       | No   |
| Service life                      | >1,000,000 actuations at 1 ±0.3 N to 3 ±0.3 N actuating force                        |
| LED luminous intensity            |  |
| Yellow                            | Typ. 38 mcd  |
| <b>Operating conditions</b>       |  |
| Pollution degree per EN 61131-2   | Pollution degree 2   |
| Degree of protection per EN 60529 | Front: IP65<br>Back: IP20 (only with installed link module or installed system unit) |
| Degree of protection per UL 50    | Front: Type 4X indoor use only   |
| <b>Mechanical properties</b>      |  |
| Front <sup>3)</sup>               |  |
| Frame                             | Aluminum, naturally anodized   |
| Panel overlay                     |  |
| Material                          | Polyester  |
| Light background color            | RAL 9006   |
| Dark border color around display  | RAL 7024   |
| Gasket                            | 3 mm fixed gasket  |
| <b>Dimensions</b>                 |  |
| Width                             | 435 mm   |
| Height                            | 330 mm   |
| Weight                            | 4900 g   |

- 1) At 25°C ambient temperature. Reducing the brightness by 50% can increase the half-brightness time by approximately 50%.
- 2) Touch screen drivers for approved operating systems are available for download in the Downloads section of the B&R website ([www.br-automation.com](http://www.br-automation.com)).
- 3) Visual deviations in color and surface quality are possible due to process or batch conditions.

### 4.2.3.17.4 Dimensions

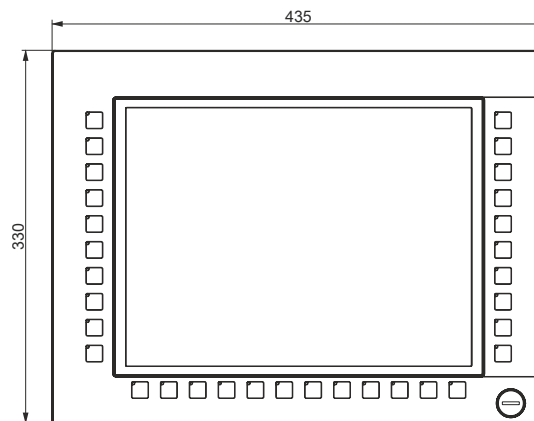

### 4.2.3.17.5 Temperature/Humidity diagram

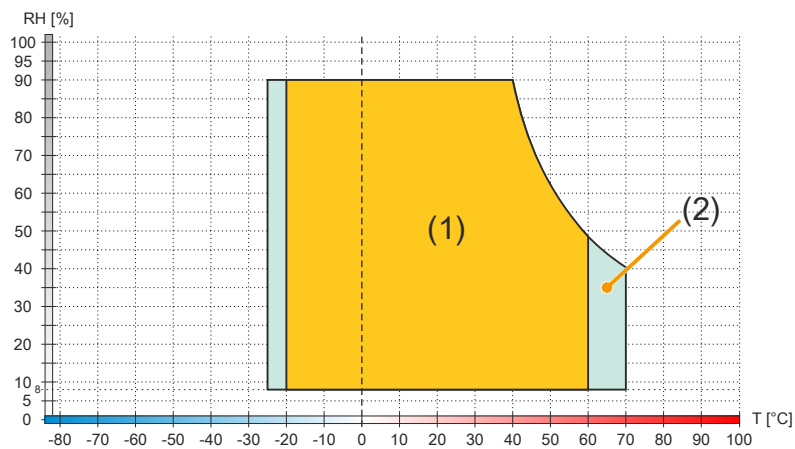

| Diagram legend |                       |        |   |
|----------------|-----------------------|--------|---|
| (1)            | Operation             | T [°C] | Temperature in °C   |
| (2)            | Storage and transport | RH [%] | Relative humidity (RH) in percent and <b>non-condensing</b> |

### 4.2.3.18 5AP1181.1505-000

#### 4.2.3.18.1 General information

- Panel for AP1000, PPC900, PPC2100, PPC2200 or PPC3100
- 15.0" TFT XGA color display
- Single-touch (analog resistive)
- 32 function keys
- 92 system keys
- Front USB interface
- Control cabinet installation

#### Information:

**This Automation Panel is not approved for DVI operation.**

#### 4.2.3.18.2 Order data

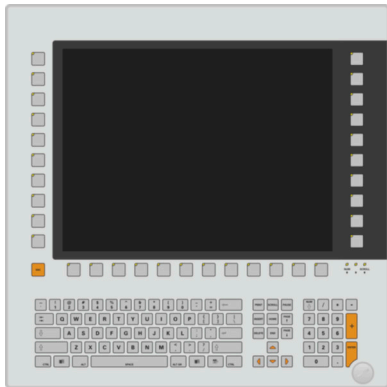
| Order number     | Short description   | Figure   |
|------------------|---|--|
| 5AP1181.1505-000 | <b>Panels</b><br>Automation Panel 15" XGA TFT - 1024 x 768 pixels (4:3) - Single-touch (analog resistive) - Control cabinet installation - Landscape format - Front USB - 32 function keys and 92 system keys - For PPC900/PPC2100/PPC3100/PPC2200 - For link modules - Compatible with 5PP581.1505-000 |  |

#### 4.2.3.18.3 Technical data

#### Information:

**The following specified characteristic data, features and limit values are only valid for these individual components and may differ from those of the complete system. The data specified for the complete system applies to the complete system in which an individual component is used.**

| Order number                       | 5AP1181.1505-000  |
|------------------------------------|---|
| <b>General information</b>         |   |
| B&R ID code                        | 0xEF61  |
| Certifications                     |   |
| CE                                 | Yes   |
| UKCA                               | Yes   |
| UL                                 | cULus E115267<br>Industrial control equipment   |
| HazLoc                             | cULus HazLoc E180196<br>Industrial control equipment<br>for hazardous locations<br>Class I, Division 2, Groups ABCD, T4 |
| <b>Display</b>                     |   |
| Type                               | TFT color   |
| Diagonal                           | 15.0"   |
| Colors                             | 16.7 million  |
| Resolution                         | XGA, 1024 x 768 pixels  |
| Contrast                           | 700:1   |
| Viewing angles                     |   |
| Horizontal                         | Direction R = 80° / Direction L = 80°   |
| Vertical                           | Direction U = 70° / Direction D = 70°   |
| Backlight                          |   |
| Type                               | LED   |
| Brightness (dimnable)              | Typ. 20 to 400 cd/m <sup>2</sup>  |
| Half-brightness time <sup>1)</sup> | 50,000 h  |

## Technical data

|                                   |  |
|-----------------------------------|--|
| <b>Order number</b>               | <b>5AP1181.1505-000</b>  |
| Touch screen <sup>2)</sup>        |  |
| Technology                        | Analog, resistive  |
| Controller                        | B&R, serial, 12-bit  |
| Transmittance                     | 81% ±3%  |
| <b>Interfaces</b>                 |  |
| USB                               |  |
| Quantity                          | 1  |
| Type                              | USB 2.0  |
| Variant                           | Type A   |
| Transfer rate                     | Low speed (1.5 Mbit/s), full speed (12 Mbit/s) to high speed (480 Mbit/s)            |
| Current-carrying capacity         | Max. 500 mA  |
| <b>Keys</b>                       |  |
| Function keys                     | 32 with LED (yellow)   |
| System keys                       | Alphanumeric keys, numeric keys, cursor block  |
| Service life                      | >1,000,000 actuations at 1 ±0.3 N to 3 ±0.3 N actuating force                        |
| LED luminous intensity            |  |
| Yellow                            | Typ. 38 mcd  |
| <b>Operating conditions</b>       |  |
| Pollution degree per EN 61131-2   | Pollution degree 2   |
| Degree of protection per EN 60529 | Front: IP65<br>Back: IP20 (only with installed link module or installed system unit) |
| Degree of protection per UL 50    | Front: Type 4X indoor use only   |
| <b>Mechanical properties</b>      |  |
| Front <sup>3)</sup>               |  |
| Frame                             | Aluminum, naturally anodized   |
| Panel overlay                     |  |
| Material                          | Polyester  |
| Light background color            | RAL 9006   |
| Dark border color around display  | RAL 7024   |
| Gasket                            | 3 mm fixed gasket  |
| Dimensions                        |  |
| Width                             | 435 mm   |
| Height                            | 430 mm   |
| Weight                            | 6000 g   |

- 1) At 25°C ambient temperature. Reducing the brightness by 50% can increase the half-brightness time by approximately 50%.
- 2) Touch screen drivers for approved operating systems are available for download in the Downloads section of the B&R website ([www.br-automation.com](http://www.br-automation.com)).
- 3) Visual deviations in color and surface quality are possible due to process or batch conditions.

### 4.2.3.18.4 Dimensions

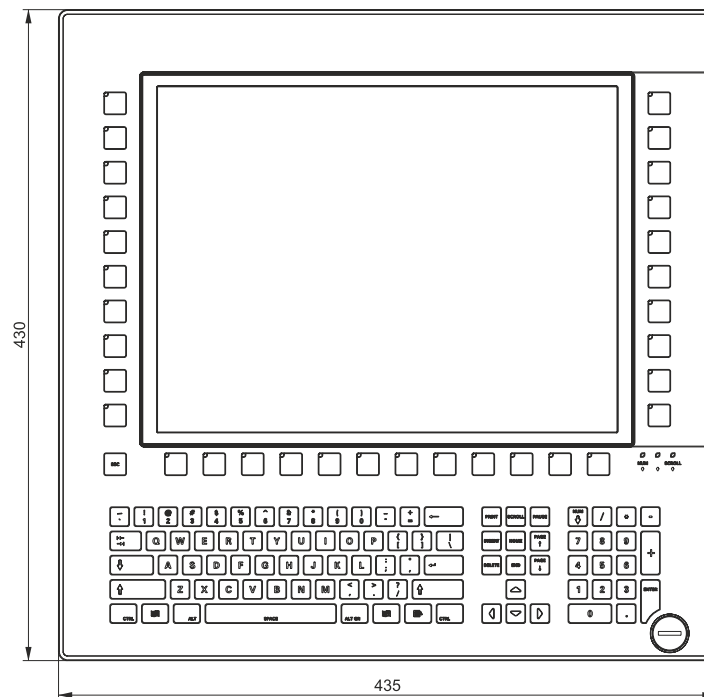

### 4.2.3.18.5 Requirements

5AP1181.1505-000 is supported starting with the following firmware versions:

- Firmware V03.15 or later with SDL/DVI receiver 5DLSDL.1001-00
- Firmware V04.11 or later with SDL3 receiver 5DLSD3.1001-00
- Firmware V06.12 or later with SDL4 receiver 5DLSD4.1001-00

**4.2.3.18.6 Temperature/Humidity diagram**

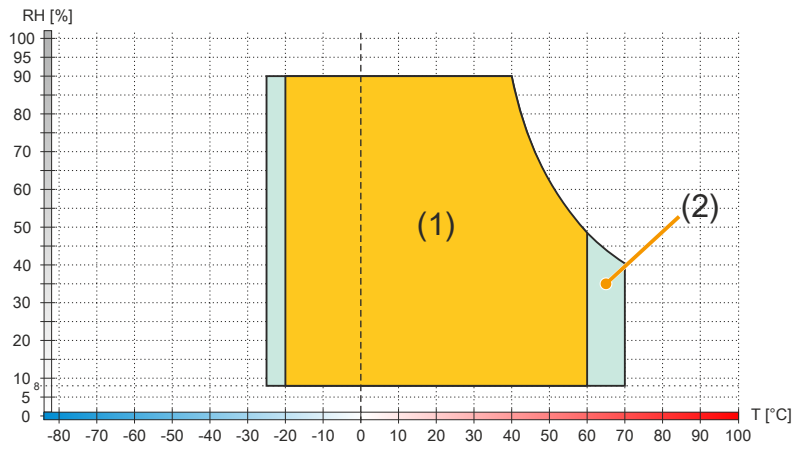

| Diagram legend |                       |        |   |
|----------------|-----------------------|--------|---|
| (1)            | Operation             | T [°C] | Temperature in °C   |
| (2)            | Storage and transport | RH [%] | Relative humidity (RH) in percent and <b>non-condensing</b> |

### 4.2.3.19 5AP1120.156B-000

#### 4.2.3.19.1 General information

- Panel for AP1000, PPC900, PPC2100, PPC2200 or PPC3100
- 15.6" TFT HD color display
- Single-touch (analog resistive)
- Control cabinet installation

#### 4.2.3.19.2 Order data

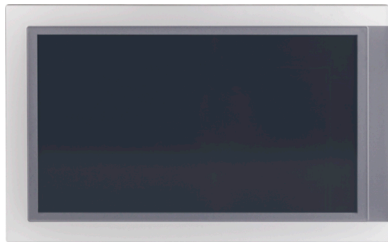
| Order number     | Short description  | Figure  |
|------------------|--|---|
| 5AP1120.156B-000 | Automation Panel 15.6" HD TFT - 1366 x 768 pixels (16:9) - Single-touch (analog resistive) - Control cabinet installation - Landscape format - For PPC900/PPC2100/PPC3100/PPC2200 - For link modules |  |

#### 4.2.3.19.3 Technical data

### Information:

The following specified characteristic data, features and limit values are only valid for these individual components and may differ from those of the complete system. The data specified for the complete system applies to the complete system in which an individual component is used.

| Order number                       | 5AP1120.156B-000  |
|------------------------------------|---|
| <b>General information</b>         |   |
| B&R ID code                        | 0xE8E5  |
| Certifications                     |   |
| CE                                 | Yes   |
| UKCA                               | Yes   |
| UL                                 | cULus E115267<br>Industrial control equipment   |
| HazLoc                             | cULus HazLoc E180196<br>Industrial control equipment<br>for hazardous locations<br>Class I, Division 2, Groups ABCD, T4 |
| <b>Display</b>                     |   |
| Type                               | TFT color   |
| Diagonal                           | 15.6"   |
| Colors                             | 16.7 million  |
| Resolution                         | HD, 1366 x 768 pixels   |
| Contrast                           | 1000:1  |
| Viewing angles                     |   |
| Horizontal                         | Direction R = 85° / Direction L = 85°   |
| Vertical                           | Direction U = 85° / Direction D = 85°   |
| Backlight                          |   |
| Type                               | LED   |
| Brightness (dimnable)              | Typ. 40 to 400 cd/m <sup>2</sup>  |
| Half-brightness time <sup>1)</sup> | 70,000 h  |
| Touch screen <sup>2)</sup>         |   |
| Technology                         | Analog, resistive   |
| Controller                         | B&R, serial, 12-bit   |
| Transmittance                      | 81% ±3%   |
| Light transmission                 | 80 ±3%  |
| Service life                       | 10,000,000 touch operations at the same position (release pressure: 250 g, interval: 0.25 s)                            |
| <b>Operating conditions</b>        |   |
| Pollution degree per EN 61131-2    | Pollution degree 2  |
| Degree of protection per EN 60529  | Front: IP65<br>Back: IP20 (only with installed link module or installed system unit)                                    |
| Degree of protection per UL 50     | Front: Type 4X indoor use only  |

|                                  |                         |
|----------------------------------|-------------------------|
| <b>Order number</b>              | <b>5AP1120.156B-000</b> |
| <b>Mechanical properties</b>     |                         |
| Front <sup>3)</sup>              |                         |
| Frame                            | Aluminum, coated        |
| Panel overlay                    |                         |
| Material                         | Polyester               |
| Light background color           | RAL 9006                |
| Dark border color around display | RAL 7024                |
| Gasket                           | 3 mm fixed gasket       |
| Dimensions                       |                         |
| Width                            | 414 mm                  |
| Height                           | 258.5 mm                |
| Weight                           | 4200 g                  |

- 1) At 25°C ambient temperature. Reducing the brightness by 50% can increase the half-brightness time by approximately 50%.
- 2) Touch screen drivers for approved operating systems are available for download in the Downloads section of the B&R website ([www.br-automation.com](http://www.br-automation.com)).
- 3) Visual deviations in color and surface quality are possible due to process or batch conditions.

#### 4.2.3.19.4 Dimensions

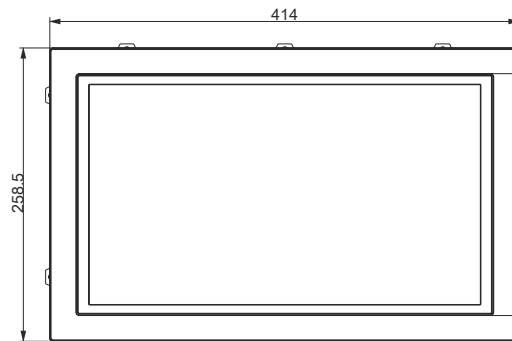

#### 4.2.3.19.5 Temperature/Humidity diagram

##### Hardware revision H0 and later

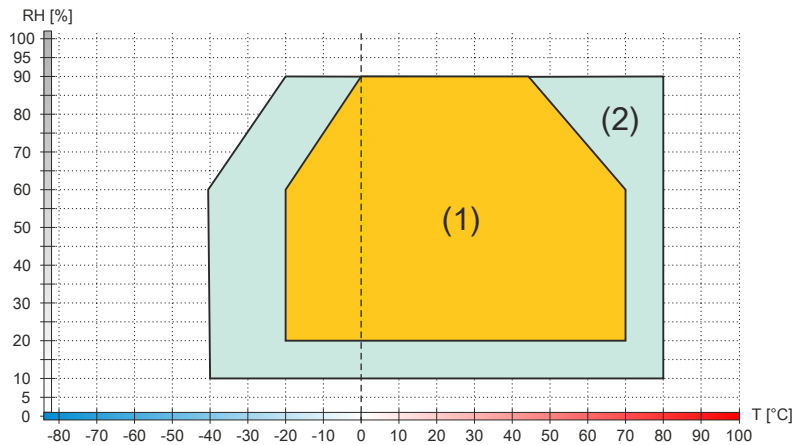

| Diagram legend |                       |        |   |
|----------------|-----------------------|--------|---|
| (1)            | Operation             | T [°C] | Temperature in °C   |
| (2)            | Storage and transport | RH [%] | Relative humidity (RH) in percent and <b>non-condensing</b> |

Up to hardware revision G0

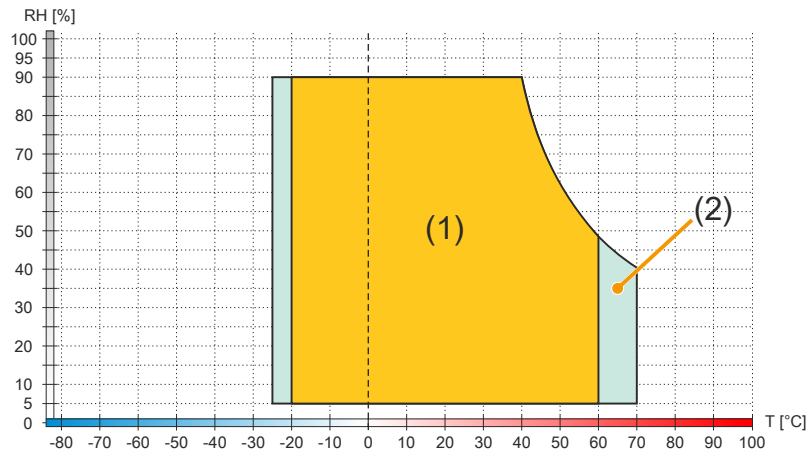

Diagram legend

| Diagram legend |                       |        |   |
|----------------|-----------------------|--------|---|
| (1)            | Operation             | T [°C] | Temperature in °C   |
| (2)            | Storage and transport | RH [%] | Relative humidity (RH) in percent and <b>non-condensing</b> |

### 4.2.3.20 5AP1130.156C-000

#### 4.2.3.20.1 General information

- Panel for AP1000, PPC900, PPC2100, PPC2200 or PPC3100
- 15.6" FHD color display
- Multi-touch (projected capacitive)
- Control cabinet installation

#### 4.2.3.20.2 Order data

| Order number     | Short description   | Figure  |
|------------------|---|---|
| 5AP1130.156C-000 | <b>Panels</b><br>Automation Panel 15.6" Full HD TFT - 1920 x 1080 pixels (16:9)<br>- Multi-touch (projected capacitive) - Control cabinet installation -<br>Landscape format - For PPC900/PPC2100/PPC3100/PPC2200<br>- For link modules |  |

#### 4.2.3.20.3 Technical data

### Information:

The following specified characteristic data, features and limit values are only valid for these individual components and may differ from those of the complete system. The data specified for the complete system applies to the complete system in which an individual component is used.

| Order number                       | 5AP1130.156C-000  |
|------------------------------------|---|
| <b>General information</b>         |   |
| B&R ID code                        | 0xEC5D  |
| Certifications                     |   |
| CE                                 | Yes   |
| UKCA                               | Yes   |
| UL                                 | cULus E115267<br>Industrial control equipment   |
| HazLoc                             | cULus HazLoc E180196<br>Industrial control equipment<br>for hazardous locations<br>Class I, Division 2, Groups ABCD, T4                     |
| DNV                                | Temperature: <b>B</b> (0 to 55°C)<br>Humidity: <b>B</b> (up to 100%)<br>Vibration: <b>A</b> (0.7 g)<br>EMC: <b>B</b> (bridge and open deck) |
| LR                                 | ENV3  |
| KR                                 | Yes   |
| ABS                                | Yes   |
| BV                                 | <b>EC31B</b><br>Temperature: 5 - 55°C<br>Vibration: 0.7 g<br>EMC: Bridge and open deck  |
| <b>Display</b>                     |   |
| Type                               | TFT color   |
| Diagonal                           | 15.6"   |
| Colors                             | 16.7 million  |
| Resolution                         | FHD, 1920 x 1080 pixels   |
| Contrast                           | 800:1   |
| Viewing angles                     |   |
| Horizontal                         | Direction R = 85° / Direction L = 85°   |
| Vertical                           | Direction U = 85° / Direction D = 85°   |
| Backlight                          |   |
| Type                               | LED   |
| Brightness (dimnable)              | Typ. 40 to 450 cd/m <sup>2</sup>  |
| Half-brightness time <sup>1)</sup> | ≥50,000 h   |
| Touch screen <sup>2)</sup>         |   |
| Technology                         | Projected capacitive touch (PCT)  |
| Transmittance                      | See "Appendix A - Touch screen".  |
| <b>Operating conditions</b>        |   |
| Pollution degree per EN 61131-2    | Pollution degree 2  |

## Technical data

|                                   |  |
|-----------------------------------|--|
| <b>Order number</b>               | <b>5AP1130.156C-000</b>  |
| Degree of protection per EN 60529 | Front: IP65<br>Back: IP20 (only with installed link module or installed system unit) |
| Degree of protection per UL 50    | Front: Type 4X indoor use only   |
| <b>Mechanical properties</b>      |  |
| Front <sup>3)</sup>               |  |
| Frame                             | Aluminum, coated   |
| Design                            | Black  |
| Gasket                            | 3 mm fixed gasket  |
| <b>Dimensions</b>                 |  |
| Width                             | 414 mm   |
| Height                            | 258.5 mm   |
| Weight                            | 3700 g   |

- 1) At 25°C ambient temperature. Reducing the brightness by 50% can increase the half-brightness time by approximately 50%.
- 2) The specifications for the touch screen driver must be taken into account. See section "Multi-touch drivers" in chapter 4 "Software".
- 3) Visual deviations in color and surface quality are possible due to process or batch conditions.

### 4.2.3.20.4 Dimensions

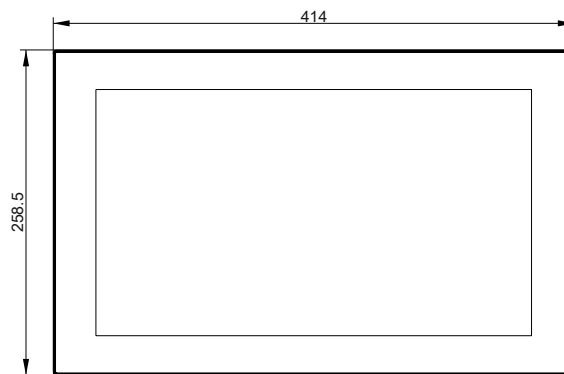

### 4.2.3.20.5 Temperature/Humidity diagram

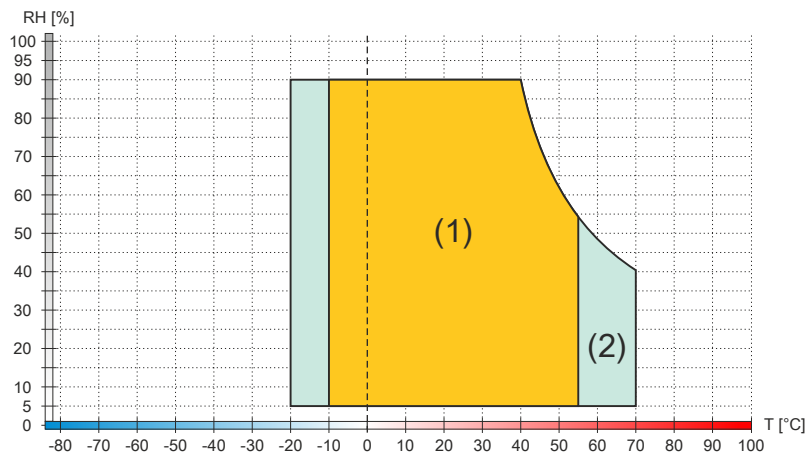

| Diagram legend |                       |        |   |
|----------------|-----------------------|--------|---|
| (1)            | Operation             | T [°C] | Temperature in °C   |
| (2)            | Storage and transport | RH [%] | Relative humidity (RH) in percent and <b>non-condensing</b> |

### 4.2.3.21 5AP1130.156C-001

#### 4.2.3.21.1 General information

- Panel for AP1000, PPC2100, PPC2200 or PPC3100
- 15.6" TFT FHD color display
- Multi-touch (projected capacitive)
- Manufactured with optical bonding technology
- Control cabinet installation

#### 4.2.3.21.2 Order data

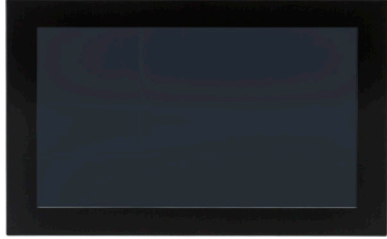
| Order number     | Short description  | Figure  |
|------------------|--|---|
| 5AP1130.156C-001 | <b>Panels</b><br>Automation Panel 15.6" Full HD TFT - 1920 x 1080 pixels (16:9)<br>- Multi-touch (projected capacitive) - Control cabinet installation<br>- Landscape format - Optical bonding - For PPC900/PPC2100/<br>PPC3100/PPC2200 - For link modules |  |

#### 4.2.3.21.3 Technical data

### Information:

The following specified characteristic data, features and limit values are only valid for these individual components and may differ from those of the complete system. The data specified for the complete system applies to the complete system in which an individual component is used.

| Order number                       | 5AP1130.156C-001  |
|------------------------------------|---|
| <b>General information</b>         |   |
| B&R ID code                        | 0x28B5  |
| Certifications                     |   |
| CE                                 | Yes   |
| UKCA                               | Yes   |
| UL                                 | cULus E115267<br>Industrial control equipment   |
| HazLoc                             | cULus HazLoc E180196<br>Industrial control equipment<br>for hazardous locations<br>Class I, Division 2, Groups ABCD, T4 |
| <b>Display</b>                     |   |
| Type                               | TFT color   |
| Diagonal                           | 15.6"   |
| Colors                             | 16.7 million  |
| Resolution                         | FHD, 1920 x 1080 pixels   |
| Contrast                           | Rev. D0 and later: 800:1<br>Up to Rev. C0: 1500:1   |
| Viewing angles                     |   |
| Horizontal                         | Direction R = 85° / Direction L = 85°   |
| Vertical                           | Direction U = 85° / Direction D = 85°   |
| Backlight                          |   |
| Type                               | LED   |
| Brightness (dimnable)              | Rev. D0 and later: Typ. 40 to 450 cd/m <sup>2</sup><br>Up to Rev. C0: Typ. 40 to 400 cd/m <sup>2</sup>                  |
| Half-brightness time <sup>1)</sup> | Rev. D0 and later: ≥50,000 h<br>Up to rev. C0: 70,000 h   |
| Touch screen <sup>2)</sup>         |   |
| Technology                         | Projected capacitive touch (PCT)  |
| Transmittance                      | See "Appendix A - Touch screen".  |
| <b>Operating conditions</b>        |   |
| Pollution degree per EN 61131-2    | Pollution degree 2  |
| Degree of protection per EN 60529  | Front: IP65<br>Back: IP20 (only with installed link module or installed system unit)                                    |
| Degree of protection per UL 50     | Front: Type 4X indoor use only  |

## Technical data

|                              |  |
|------------------------------|--|
| <b>Order number</b>          | <b>5AP1130.156C-001</b>  |
| <b>Mechanical properties</b> |  |
| Front <sup>3)</sup>          |  |
| Frame                        | Aluminum, coated   |
| Design                       | Black  |
| Gasket                       | 3 mm fixed gasket  |
| <b>Dimensions</b>            |  |
| Width                        | 414 mm   |
| Height                       | 258.5 mm   |
| Weight                       | Rev. D0 and later: Approx. 3,905 g<br>Up to rev. C0: Approx. 3,800 g |

- 1) At 25°C ambient temperature. Reducing the brightness by 50% can increase the half-brightness time by approximately 50%.
- 2) The specifications for the touch screen driver must be taken into account. See section "Multi-touch drivers" in chapter 4 "Software".
- 3) Visual deviations in color and surface quality are possible due to process or batch conditions.

### 4.2.3.21.4 Dimensions

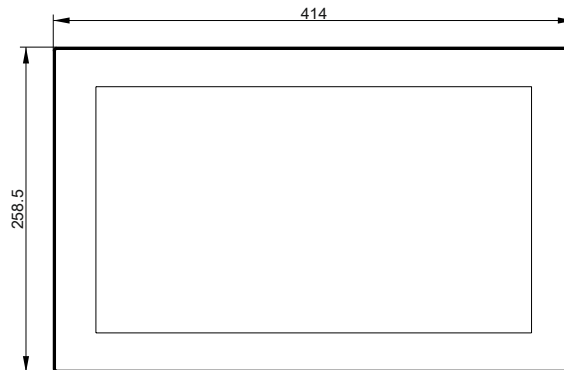

### 4.2.3.21.5 Temperature/Humidity diagram

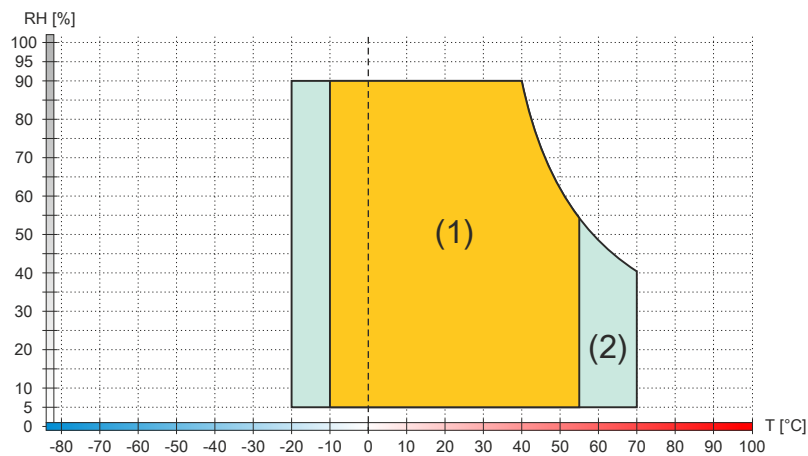

| Diagram legend |                       |        |   |
|----------------|-----------------------|--------|---|
| (1)            | Operation             | T [°C] | Temperature in °C   |
| (2)            | Storage and transport | RH [%] | Relative humidity (RH) in percent and <b>non-condensing</b> |

## 4.2.3.22 5AP1130.185C-000

### 4.2.3.22.1 General information

- Panel for AP1000, PPC900, PPC2100, PPC2200 or PPC3100
- 18.5" FHD color display
- Multi-touch (projected capacitive)
- Control cabinet installation

### 4.2.3.22.2 Order data

| Order number     | Short description   | Figure  |
|------------------|---|---|
| 5AP1130.185C-000 | <b>Panels</b><br>Automation Panel 18.5" Full HD TFT - 1920 x 1080 pixels (16:9)<br>- Multi-touch (projected capacitive) - Control cabinet installation -<br>Landscape format - For PPC900/PPC2100/PPC3100/PPC2200<br>- For link modules |  |

### 4.2.3.22.3 Technical data

#### Information:

The following specified characteristic data, features and limit values are only valid for these individual components and may differ from those of the complete system. The data specified for the complete system applies to the complete system in which an individual component is used.

| Order number                       | 5AP1130.185C-000  |
|------------------------------------|---|
| <b>General information</b>         |   |
| B&R ID code                        | 0xEC5E  |
| Certifications                     |   |
| CE                                 | Yes   |
| UKCA                               | Yes   |
| UL                                 | cULus E115267<br>Industrial control equipment   |
| HazLoc                             | cULus HazLoc E180196<br>Industrial control equipment<br>for hazardous locations<br>Class I, Division 2, Groups ABCD, T4                     |
| DNV                                | Temperature: <b>B</b> (0 to 55°C)<br>Humidity: <b>B</b> (up to 100%)<br>Vibration: <b>A</b> (0.7 g)<br>EMC: <b>B</b> (bridge and open deck) |
| LR                                 | ENV3  |
| ABS                                | Yes   |
| BV                                 | <b>EC31B</b><br>Temperature: 5 - 55°C<br>Vibration: 0.7 g<br>EMC: Bridge and open deck  |
| <b>Display</b>                     |   |
| Type                               | TFT color   |
| Diagonal                           | 18.5"   |
| Colors                             | 16.7 million  |
| Resolution                         | FHD, 1920 x 1080 pixels   |
| Contrast                           | 1500:1  |
| Viewing angles                     |   |
| Horizontal                         | Direction R = 85° / Direction L = 85°   |
| Vertical                           | Direction U = 85° / Direction D = 85°   |
| Backlight                          |   |
| Type                               | LED   |
| Brightness (dimnable)              | Typ. 40 to 400 cd/m <sup>2</sup>  |
| Half-brightness time <sup>1)</sup> | 50,000 h  |
| Touch screen <sup>2)</sup>         |   |
| Technology                         | Projected capacitive touch (PCT)  |
| Transmittance                      | See "Appendix A - Touch screen".  |
| <b>Operating conditions</b>        |   |
| Pollution degree per EN 61131-2    | Pollution degree 2  |
| Degree of protection per EN 60529  | Front: IP65<br>Back: IP20 (only with installed link module or installed system unit)  |

## Technical data

|                                |                                |
|--------------------------------|--------------------------------|
| <b>Order number</b>            | <b>5AP1130.185C-000</b>        |
| Degree of protection per UL 50 | Front: Type 4X indoor use only |
| <b>Mechanical properties</b>   |                                |
| Front <sup>3)</sup>            |                                |
| Frame                          | Aluminum, coated               |
| Design                         | Black                          |
| Gasket                         | 3 mm fixed gasket              |
| <b>Dimensions</b>              |                                |
| Width                          | 475 mm                         |
| Height                         | 295 mm                         |
| Weight                         | 4700 g                         |

- 1) At 25°C ambient temperature. Reducing the brightness by 50% can increase the half-brightness time by approximately 50%.
- 2) The specifications for the touch screen driver must be taken into account. See section "Multi-touch drivers" in chapter 4 "Software".
- 3) Visual deviations in color and surface quality are possible due to process or batch conditions.

### 4.2.3.22.4 Dimensions

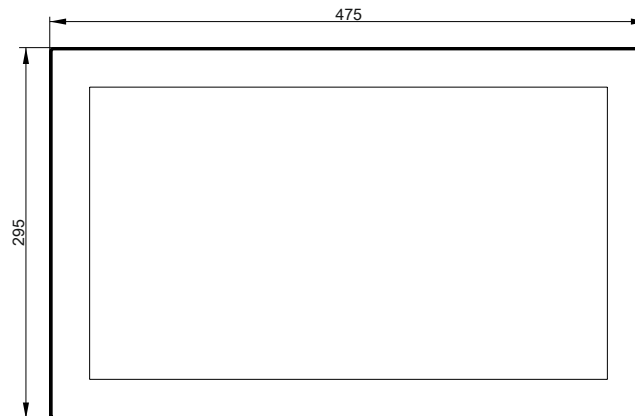

### 4.2.3.22.5 Temperature/Humidity diagram

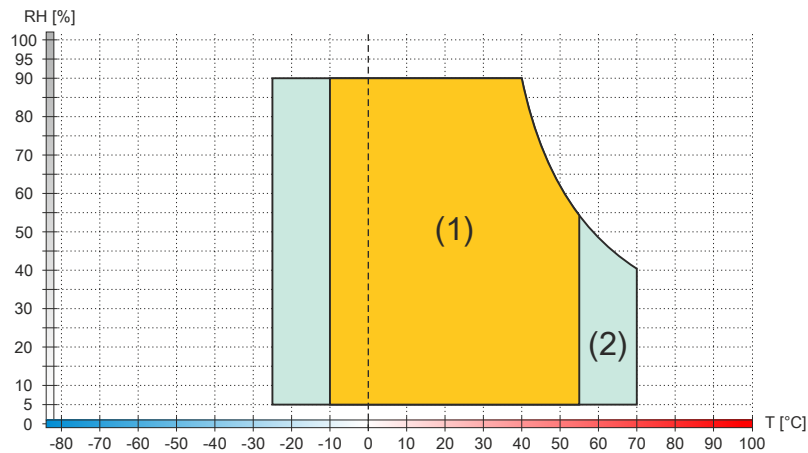

| Diagram legend |                       |        |   |
|----------------|-----------------------|--------|---|
| (1)            | Operation             | T [°C] | Temperature in °C   |
| (2)            | Storage and transport | RH [%] | Relative humidity (RH) in percent and <b>non-condensing</b> |

### 4.2.3.23 5AP1120.1906-000

#### 4.2.3.23.1 General information

- Panel for AP1000, PPC900, PPC2100, PPC2200 or PPC3100
- 19.0" TFT SXGA color display
- Single-touch (analog resistive)
- Front USB interface
- Control cabinet installation

#### 4.2.3.23.2 Order data

| Order number     | Short description  | Figure  |
|------------------|--|---|
| 5AP1120.1906-000 | <b>Panels</b><br>Automation Panel 19.0" SXGA TFT - 1280 x 1024 pixels (5:4) - Single-touch (analog resistive) - Control cabinet installation - Landscape format - Front USB - For PPC900/PPC2100/PPC3100/PPC2200 - For link modules - Compatible with 5AP920.1906-01, 5PC720.1906-00, 5PC820.1906-00 |  |

#### 4.2.3.23.3 Technical data

### Information:

The following specified characteristic data, features and limit values are only valid for these individual components and may differ from those of the complete system. The data specified for the complete system applies to the complete system in which an individual component is used.

| Order number                       | 5AP1120.1906-000  |
|------------------------------------|---|
| <b>General information</b>         |   |
| B&R ID code                        | 0xE7BE  |
| Certifications                     |   |
| CE                                 | Yes   |
| UKCA                               | Yes   |
| UL                                 | cULus E115267<br>Industrial control equipment   |
| HazLoc                             | cULus HazLoc E180196<br>Industrial control equipment<br>for hazardous locations<br>Class I, Division 2, Groups ABCD, T4                     |
| DNV                                | Temperature: <b>B</b> (0 to 55°C)<br>Humidity: <b>B</b> (up to 100%)<br>Vibration: <b>A</b> (0.7 g)<br>EMC: <b>B</b> (bridge and open deck) |
| LR                                 | ENV3  |
| KR                                 | Yes   |
| ABS                                | Yes   |
| BV                                 | <b>EC31B</b><br>Temperature: 5 - 55°C<br>Vibration: 0.7 g<br>EMC: Bridge and open deck  |
| <b>Display</b>                     |   |
| Type                               | TFT color   |
| Diagonal                           | 19.0"   |
| Colors                             | 16.2 million  |
| Resolution                         | SXGA, 1280 x 1024 pixels  |
| Contrast                           | 1500:1  |
| Viewing angles                     |   |
| Horizontal                         | Direction R = 85° / Direction L = 85°   |
| Vertical                           | Direction U = 85° / Direction D = 85°   |
| Backlight                          |   |
| Type                               | LED   |
| Brightness (dimnable)              | Typ. 35 to 350 cd/m <sup>2</sup>  |
| Half-brightness time <sup>1)</sup> | 70,000 h  |

## Technical data

|                                   |  |
|-----------------------------------|--|
| <b>Order number</b>               | <b>5AP1120.1906-000</b>  |
| Touch screen <sup>2)</sup>        |  |
| Technology                        | Analog, resistive  |
| Controller                        | B&R, serial, 12-bit  |
| Transmittance                     | 81% ±3%  |
| <b>Interfaces</b>                 |  |
| USB                               |  |
| Quantity                          | 1  |
| Type                              | USB 2.0  |
| Variant                           | Type A   |
| Transfer rate                     | Low speed (1.5 Mbit/s), full speed (12 Mbit/s) to high speed (480 Mbit/s)            |
| Current-carrying capacity         | Max. 500 mA  |
| <b>Operating conditions</b>       |  |
| Pollution degree per EN 61131-2   | Pollution degree 2   |
| Degree of protection per EN 60529 | Front: IP65<br>Back: IP20 (only with installed link module or installed system unit) |
| Degree of protection per UL 50    | Front: Type 4X indoor use only   |
| <b>Mechanical properties</b>      |  |
| Front <sup>3)</sup>               |  |
| Frame                             | Aluminum, naturally anodized   |
| Panel overlay                     |  |
| Material                          | Polyester  |
| Light background color            | RAL 9006   |
| Dark border color around display  | RAL 7024   |
| Gasket                            | 3 mm fixed gasket  |
| Dimensions                        |  |
| Width                             | 527 mm   |
| Height                            | 421 mm   |
| Weight                            | 7300 g   |

- 1) At 25°C ambient temperature. Reducing the brightness by 50% can increase the half-brightness time by approximately 50%.
- 2) Touch screen drivers for approved operating systems are available for download in the Downloads section of the B&R website ([www.br-automation.com](http://www.br-automation.com)).
- 3) Visual deviations in color and surface quality are possible due to process or batch conditions.

### 4.2.3.23.4 Dimensions

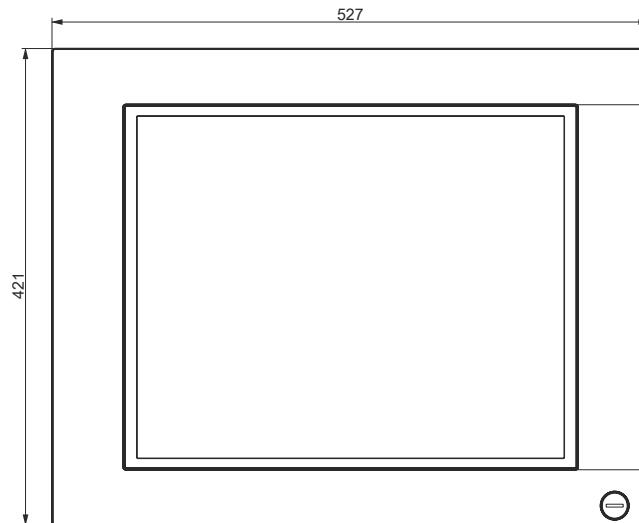

4.2.3.23.5 Temperature/Humidity diagram

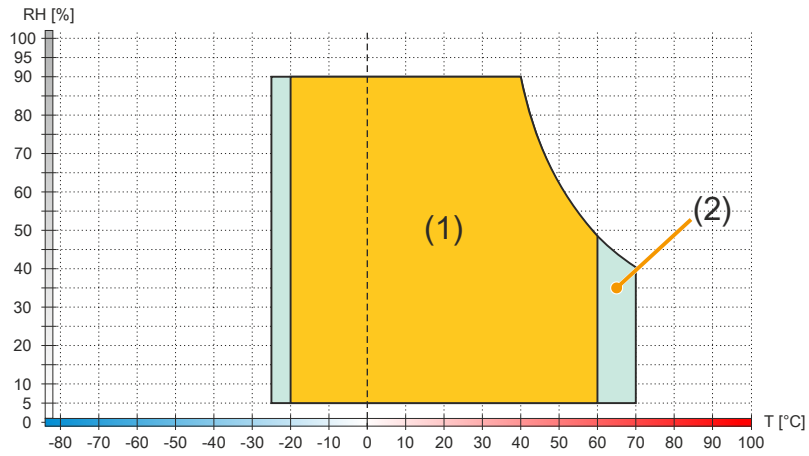

| Diagram legend |                       |        |   |
|----------------|-----------------------|--------|---|
| (1)            | Operation             | T [°C] | Temperature in °C   |
| (2)            | Storage and transport | RH [%] | Relative humidity (RH) in percent and <b>non-condensing</b> |

## 4.2.4 Interface options

### Information:

It is important to note that not every interface option can be connected to interface slot IF1 and IFx. For additional information, see section "IF option slot(IF1, IFx)" on page 53.

### Information:

Interface options can only be installed and replaced at the B&R factory.

### 4.2.4.1 5ACCIF01.FPCC-000

#### 4.2.4.1.1 General information

Interface option 5ACCIF01.FPCC-000 is equipped with a POWERLINK interface, 2 CAN bus master interfaces and an X2X Link master interface. In addition, 512 kB nvSRAM is installed.

- 1x POWERLINK interface managing or controlled node
- 2x CAN bus master interfaces
- 1x X2X Link master interface
- 512 kB nvSRAM
- Compatible with APC2100/PPC2100 and APC2200/PPC2200

This interface option can only be operated with Automation Runtime.

#### 4.2.4.1.2 Order data

| Order number      | Short description  | Figure  |
|-------------------|--|---|
|                   | <b>Interface options</b>   |  |
| 5ACCIF01.FPCC-000 | Interface card - 2x CAN interfaces - 1x X2X Link interface - 1x POWERLINK interface - 512 kB nvSRAM - For APC2100/PPC2100/APC2200/PPC2200 - Only available with a new device |   |
|                   | <b>Optional accessories</b>  |   |
|                   | <b>Terminal blocks</b>   |   |
| 0TB1210.3100      | Connector 300 VDC - 10-pin female - Cage clamp terminal block - Protected against vibration by the screw flange  |   |

#### 4.2.4.1.3 Technical data

### Information:

The following specified characteristic data, features and limit values are only valid for this accessory and may differ from those of the complete system. The data specified for the complete system applies to the complete system in which an accessory is used.

| Order number               | 5ACCIF01.FPCC-000   |
|----------------------------|---|
| <b>General information</b> |   |
| LEDs                       | L1, L2, L3  |
| B&R ID code                | 0xE9BD  |
| Certifications             |   |
| CE                         | Yes   |
| UKCA                       | Yes   |
| UL                         | cULus E115267<br>Industrial control equipment   |
| HazLoc                     | cULus HazLoc E180196<br>Industrial control equipment<br>for hazardous locations<br>Class I, Division 2, Groups ABCD, T4                     |
| DNV                        | Temperature: <b>B</b> (0 to 55°C)<br>Humidity: <b>B</b> (up to 100%)<br>Vibration: <b>A</b> (0.7 g)<br>EMC: <b>B</b> (bridge and open deck) |
| LR                         | ENV3  |
| KR                         | Yes   |
| ABS                        | Yes   |
| BV                         | <b>EC31B</b><br>Temperature: 5 - 55°C<br>Vibration: 0.7 g<br>EMC: Bridge and open deck  |

|  |  |
|--|--|
| <b>Order number</b>                      | <b>5ACCIF01.FPCC-000</b>                                   |
| <b>Controller</b>                        |  |
| nvSRAM                                   |  |
| Size                                     | 512 kB   |
| Data retention                           | 20 years   |
| Read/Write endurance                     | Min. 1,000,000   |
| Battery-backed                           | No   |
| Remanent variables in power failure mode | 256 kB (for e.g. Automation Runtime, see Automation Help)  |
| <b>Interfaces</b>                        |  |
| <b>POWERLINK</b>                         |  |
| Quantity                                 | 1  |
| Type                                     | Type 4 <sup>1)</sup>                                       |
| Variant                                  | RJ45, shielded   |
| Transfer rate                            | 100 Mbit/s   |
| Transfer                                 | 100BASE-TX   |
| Line length                              | Max. 100 m between two stations (segment length)           |
| <b>CAN</b>                               |  |
| Quantity                                 | 2  |
| Variant                                  | 10-pin, male <sup>2)</sup>                                 |
| Transfer rate                            | Max. 1 Mbit/s  |
| Terminating resistor                     |  |
| Type                                     | Can be switched on and off with slide switch <sup>3)</sup> |
| Default setting                          | Each off   |
| <b>X2X</b>                               |  |
| Type                                     | X2X Link master  |
| Quantity                                 | 1  |
| Variant                                  | 10-pin, male, galvanically isolated                        |
| <b>Electrical properties</b>             |  |
| Power consumption                        | 2 W  |
| <b>Operating conditions</b>              |  |
| Pollution degree per EN 61131-2          | Pollution degree 2   |
| <b>Ambient conditions</b>                |  |
| <b>Temperature</b>                       |  |
| Operation                                | -20 to 55°C  |
| Storage                                  | -20 to 60°C  |
| Transport                                | -20 to 60°C  |
| <b>Relative humidity</b>                 |  |
| Operation                                | 5 to 90%, non-condensing                                   |
| Storage                                  | 5 to 95%, non-condensing                                   |
| Transport                                | 5 to 95%, non-condensing                                   |
| <b>Mechanical properties</b>             |  |
| Weight                                   | 25 g   |

- 1) For additional information, see Automation Help (**Communication / POWERLINK / General information / Hardware - IF / LS**).
- 2) CAN1: Galvanically isolated.  
CAN2: Not galvanically isolated.
- 3) The terminating resistor can only be switched on/off for the CAN1 interface.

#### 4.2.4.1.3.1 POWERLINK interface - Pinout

The POWERLINK interface on the system unit is referred to as "IF1".

| POWERLINK - IF1 <sup>1)2)</sup> |   |                                   |
|---------------------------------|---|-----------------------------------|
| Variant                         | RJ45, female                                      |                                   |
| Wiring                          | S/STP (Cat 5e)                                    |                                   |
| Cable length                    | Max. 100 m (min. Cat 5e)                          |                                   |
| <b>LED status indicator (b)</b> | <b>On</b>   | <b>Off</b>                        |
| Green                           | see "LED "S/E" (status/error LED)" on page 287    |                                   |
| <b>LED "Link" (a)</b>           | <b>On</b>   | <b>Active</b>                     |
| Yellow                          | Link (a connection to a POWERLINK network exists) | Blinking (data being transferred) |

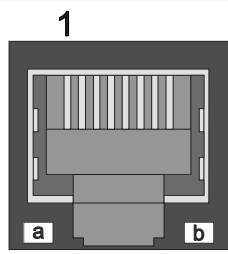

- 1) The interfaces, etc. available on the device or module have been numbered for the purpose of clear differentiation. This numbering may deviate from the numbering used by the respective operating system, however.
- 2) In Automation Studio / Automation Runtime, this interface is referred to as IF1.

### 4.2.4.1.3.2 CAN bus 1 interface - Pinout

The CAN bus 1 interface on the system unit is referred to as "IFx".

A terminating resistor can be switched on or off for the CAN bus 1 interface. LED status indicator "L1" indicates whether the terminating resistor is switched on or off.

| CAN bus 1 - IFx <sup>1)2)</sup> |               |
|---------------------------------|---------------|
| Variant                         | 10-pin, male  |
| Galvanic isolation              | Yes           |
| Transfer rate                   | Max. 1 Mbit/s |
| Bus length                      | Max. 1000 m   |
| Pin                             | Pinout        |
| 1                               | -             |
| 2                               | Shield        |
| 3                               | -             |
| 4                               | -             |
| 5                               | CAN H         |
| 6                               | CAN L         |
| 7                               | CAN GND       |
| 8                               | -             |
| 9                               | -             |
| 10                              | -             |

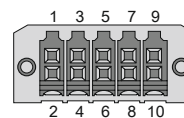

- 1) The interfaces, etc. available on the device or module have been numbered for the purpose of clear differentiation. This numbering may deviate from the numbering used by the respective operating system, however.
- 2) This interface can only be used in Automation Runtime and is displayed as IF3 in Automation Studio / Automation Runtime. It is not a "PC interface" and therefore not displayed in BIOS.

### CAN driver settings

The baud rate can be set either with "predefined values" or via the "bit timing register". For additional information, see Automation Help.

| Bit timing register 0 | Bit timing register 1 | Baud rate   |
|-----------------------|-----------------------|-------------|
| 00h                   | 14h                   | 1000 kbit/s |
| 80h or 00h            | 1Ch                   | 500 kbit/s  |
| 81h or 01h            | 1Ch                   | 250 kbit/s  |
| 83h or 03h            | 1Ch                   | 125 kbit/s  |
| 84h or 04h            | 1Ch                   | 100 kbit/s  |
| 89h or 09h            | 1Ch                   | 50 kbit/s   |

### Cable data

For more detailed information about the transfer rate, bus length or cable requirements for the respective interfaces/buses, see "Cable data" on page 285.

### Terminating resistor

A terminating resistor is integrated on the interface option. A switch is used to switch the terminating resistor for the CAN bus 1 interface on and off. The terminating resistor cannot be switched on and off for the CAN bus 2 interface. LED status indicator "L1" indicates whether the terminating resistor of the CAN bus 1 interface is switched on or off.

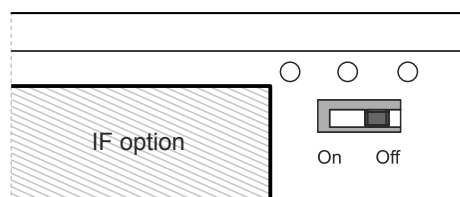

- ON: Switched on
- OFF (default): Switched off

### 4.2.4.1.3.3 CAN bus 2 interface - Pinout

The CAN bus 2 interface on the system unit is referred to as "IFx".

The terminating resistor cannot be switched on and off for the CAN bus 2 interface. A terminating resistor must therefore be taken into account during wiring.

| CAN bus 2 - IFx <sup>1)2)</sup> |               |
|---------------------------------|---------------|
| Variant                         | 10-pin, male  |
| Galvanic isolation              | No            |
| Transfer rate                   | Max. 1 Mbit/s |
| Bus length                      | Max. 1000 m   |
| Pin                             | Pinout        |
| 1                               | -             |
| 2                               | Shield        |
| 3                               | -             |
| 4                               | -             |
| 5                               | -             |
| 6                               | -             |
| 7                               | -             |
| 8                               | CAN GND       |
| 9                               | CAN L         |
| 10                              | CAN H         |

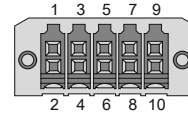

- 1) The interfaces, etc. available on the device or module have been numbered for the purpose of clear differentiation. This numbering may deviate from the numbering used by the respective operating system, however.
- 2) This interface can only be used in Automation Runtime and is displayed as IF4 in Automation Studio / Automation Runtime. It is not a "PC interface" and therefore not displayed in BIOS.

### CAN driver settings

The baud rate can be set either with "predefined values" or via the "bit timing register". For additional information, see Automation Help.

| Bit timing register 0 | Bit timing register 1 | Baud rate   |
|-----------------------|-----------------------|-------------|
| 00h                   | 14h                   | 1000 kbit/s |
| 80h or 00h            | 1Ch                   | 500 kbit/s  |
| 81h or 01h            | 1Ch                   | 250 kbit/s  |
| 83h or 03h            | 1Ch                   | 125 kbit/s  |
| 84h or 04h            | 1Ch                   | 100 kbit/s  |
| 89h or 09h            | 1Ch                   | 50 kbit/s   |

### Cable data

For more detailed information about the transfer rate, bus length or cable requirements for the respective interfaces/buses, see "Cable data" on page 285.

### 4.2.4.1.3.4 X2X Link master interface - Pinout

The X2X Link master interface on the system unit is referred to as "IFx".

| X2X Link master - IFx <sup>1)2)</sup> |                  |
|---------------------------------------|------------------|
| Variant                               | 10-pin, male     |
| Galvanic isolation                    | Yes              |
| Pin                                   | Pinout           |
| 1                                     | X2X              |
| 2                                     | Shield           |
| 3                                     | X2X <sub>I</sub> |
| 4                                     | X2X <sub>L</sub> |
| 5                                     | -                |
| 6                                     | -                |
| 7                                     | -                |
| 8                                     | -                |
| 9                                     | -                |
| 10                                    | -                |

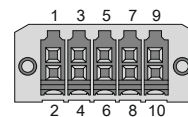

- 1) The interfaces, etc. available on the device or module have been numbered for the purpose of clear differentiation. This numbering may deviate from the numbering used by the respective operating system, however.
- 2) This interface can only be used in Automation Runtime and is displayed as IF2 in Automation Studio / Automation Runtime. It is not a "PC interface" and therefore not displayed in BIOS.

#### 4.2.4.1.3.5 LED status indicators L1, L2, L3

The LEDs of the interface option are located near the ETH1 interface.

| LED status indicators |           |          |   |
|-----------------------|-----------|----------|---|
| LED                   | Color     | Status   | Explanation   |
| L1                    | Yellow    | On       | The CAN bus 1 terminating resistor is switched on.                            |
|                       |           | Off      | The CAN bus 1 terminating resistor is switched off.                           |
| L2                    | Green     | On       | POWERLINK link LED<br>A connection to a POWERLINK network exists.             |
|                       |           | Blinking | POWERLINK link LED<br>Data is being transferred.                              |
| L3                    | Green-Red | On       | POWERLINK status/error LED<br>See "LED "S/E" (status/error LED)" on page 287. |
|                       |           | Off      | POWERLINK status/error LED<br>See "LED "S/E" (status/error LED)" on page 287. |

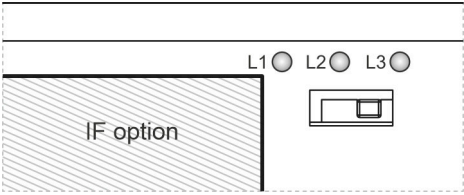

The diagram shows a rectangular panel with a hatched area on the left labeled 'IF option'. To the right of this area are three circular LEDs labeled L1, L2, and L3. Below the LEDs is a small rectangular component with a square cutout.

#### POWERLINK commissioning and operation

For a description of the operating modes, status and node numbers of the POWERLINK interface(s), see "LED "S/E" (status/error LED)" on page 287.

#### 4.2.4.1.4 Shielding

For the interfaces on the 10-pin female connector, the shield of the interfaces can be connected to pin *Shield* (pin 2) of the female connector.

In addition, there is a functional ground connection on the interface cover of the system unit and a screw point for cable shields that can also be used for the shielded cables.

#### 4.2.4.1.5 Driver support and firmware update

The driver is part of the Automation Runtime and the firmware is part of Automation Studio. The module is automatically brought up to this level.

To update the firmware contained in Automation Studio, a hardware upgrade must be performed (see **Project management / Workspace / Upgrades** in Automation Help).

### 4.2.4.2 5ACCIF01.FPCS-000

#### 4.2.4.2.1 General information

Interface option 5ACCIF01.FPCS-000 is equipped with a POWERLINK, RS485 and CAN bus master interface. In addition, 32 kB FRAM is installed.

- 1x POWERLINK interface managing or controlled node
- 1x CAN bus master interface
- 1x RS485 interface
- 32 kB FRAM
- Compatible with APC2100/PPC2100 and APC2200/PPC2200

This interface option can only be operated with Automation Runtime.

#### 4.2.4.2.2 Order data

| Order number      | Short description  | Figure  |
|-------------------|--|---|
| 5ACCIF01.FPCS-000 | <b>Interface options</b><br>Interface card - 1x RS485 interface - 1x CAN interface - 1x POWERLINK interface - 32 kB FRAM - For APC2100/PPC2100/ APC2200/PPC2200 - Only available with a new device |  |
|                   | <b>Optional accessories</b><br><b>Terminal blocks</b>  |   |
| 0TB1210.3100      | Connector 300 VDC - 10-pin female - Cage clamp terminal block - Protected against vibration by the screw flange  |   |

#### 4.2.4.2.3 Technical data

### Information:

The following specified characteristic data, features and limit values are only valid for this accessory and may differ from those of the complete system. The data specified for the complete system applies to the complete system in which an accessory is used.

| Order number                             | 5ACCIF01.FPCS-000   |
|--|---|
| <b>General information</b>               |   |
| LEDs                                     | L1, L2, L3  |
| B&R ID code                              | 0xED7C  |
| <b>Certifications</b>                    |   |
| CE                                       | Yes   |
| UKCA                                     | Yes   |
| UL                                       | cULus E115267<br>Industrial control equipment   |
| HazLoc                                   | cULus HazLoc E180196<br>Industrial control equipment for hazardous locations<br>Class I, Division 2, Groups ABCD, T4                        |
| DNV                                      | Temperature: <b>B</b> (0 to 55°C)<br>Humidity: <b>B</b> (up to 100%)<br>Vibration: <b>A</b> (0.7 g)<br>EMC: <b>B</b> (bridge and open deck) |
| LR                                       | ENV3  |
| ABS                                      | Yes   |
| BV                                       | <b>EC31B</b><br>Temperature: 5 - 55°C<br>Vibration: 0.7 g<br>EMC: Bridge and open deck  |
| <b>Controller</b>                        |   |
| <b>FRAM</b>                              |   |
| Size                                     | 32 kB   |
| Data retention                           | 10 years  |
| Read/Write endurance                     | Min. 10 <sup>12</sup> times/byte  |
| Remanent variables in power failure mode | 32 kB<br>(for e.g. Automation Runtime, see Automation Help)   |
| <b>Interfaces</b>                        |   |
| <b>COM</b>                               |   |
| Quantity                                 | 1   |
| Type                                     | RS485, not galvanically isolated  |
| Variant                                  | 10-pin, male  |
| UART                                     | 16550-compatible, 16-byte FIFO buffer   |
| Max. baud rate                           | 115 kbit/s  |

## Technical data

|                                 |  |
|---------------------------------|--|
| <b>Order number</b>             | <b>5ACCIF01.FPCS-000</b>                         |
| <b>POWERLINK</b>                |  |
| Quantity                        | 1  |
| Type                            | Type 4 <sup>1)</sup>                             |
| Variant                         | RJ45, shielded                                   |
| Transfer rate                   | 100 Mbit/s                                       |
| Transfer                        | 100BASE-TX                                       |
| Line length                     | Max. 100 m between two stations (segment length) |
| <b>CAN</b>                      |  |
| Quantity                        | 1  |
| Variant                         | 10-pin, male, not galvanically isolated          |
| Transfer rate                   | Max. 1 Mbit/s                                    |
| Terminating resistor            |  |
| Type                            | Can be switched on and off with slide switch     |
| Default setting                 | Off  |
| <b>Electrical properties</b>    |  |
| Power consumption               | 1.75 W   |
| <b>Operating conditions</b>     |  |
| Pollution degree per EN 61131-2 | Pollution degree 2                               |
| <b>Ambient conditions</b>       |  |
| Temperature                     |  |
| Operation                       | -20 to 55°C                                      |
| Storage                         | -20 to 60°C                                      |
| Transport                       | -20 to 60°C                                      |
| Relative humidity               |  |
| Operation                       | 5 to 90%, non-condensing                         |
| Storage                         | 5 to 95%, non-condensing                         |
| Transport                       | 5 to 95%, non-condensing                         |
| <b>Mechanical properties</b>    |  |
| Weight                          | 25 g   |

1) For additional information, see Automation Help (**Communication / POWERLINK / General information / Hardware - IF / LS**).

### 4.2.4.2.3.1 POWERLINK interface - Pinout

The POWERLINK interface on the system unit is referred to as "IF1".

| POWERLINK - IF1 <sup>1)2)</sup> |   |                                   |
|---------------------------------|---|-----------------------------------|
| Variant                         | RJ45, female                                      |                                   |
| Wiring                          | S/STP (Cat 5e)                                    |                                   |
| Cable length                    | Max. 100 m (min. Cat 5e)                          |                                   |
| <b>LED status indicator (b)</b> | <b>On</b>   | <b>Off</b>                        |
| Green                           | See status/error LED.                             |                                   |
| <b>LED "Link" (a)</b>           | <b>On</b>   | <b>Active</b>                     |
| Yellow                          | Link (a connection to a POWERLINK network exists) | Blinking (data being transferred) |

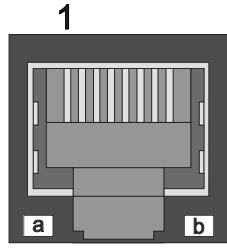

The diagram shows a female RJ45 connector labeled '1'. Below the connector, two LEDs are indicated: 'a' (yellow) and 'b' (green).

- 1) The interfaces, etc. available on the device or module have been numbered for the purpose of clear differentiation. This numbering may deviate from the numbering used by the respective operating system, however.
- 2) In Automation Studio / Automation Runtime, this interface is referred to as IF1.

#### 4.2.4.2.3.2 Serial interface COM - Pinout

Serial interface COM on the system unit is referred to as "IFx".

| Serial interface COM - IFx <sup>1)2)</sup> |  |
|--|--|
| Variant                                    | RS485                                    |
| Type                                       | 10-pin, male                             |
| Galvanic isolation                         | RS485                                    |
| UART                                       | No                                       |
| Transfer rate                              | 16550-compatible,<br>16-byte FIFO buffer |
| Bus length                                 | Max. 115 kbit/s                          |
|  | Max. 1200 m                              |
| Pin  | Pinout                                   |
| 1  | -  |
| 2  | Shield                                   |
| 3  | -  |
| 4  | -  |
| 5  | -  |
| 6  | -  |
| 7  | -  |
| 8  | COM GND                                  |
| 9  | DATA\                                    |
| 10   | DATA                                     |

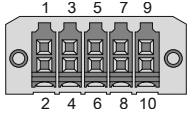

- 1) The interfaces, etc. available on the device or module have been numbered for the purpose of clear differentiation. This numbering may deviate from the numbering used by the respective operating system, however.
- 2) This interface can only be used in Automation Runtime and is displayed as IF7 in Automation Studio / Automation Runtime. It is not a "PC interface" and therefore not displayed in BIOS.

The RTS line must be switched by the driver for each transmission or reception; switching back does not take place automatically.

With long cable lengths, the voltage drop can result in greater potential differences between the bus devices, which can hinder communication. This can be improved by running the ground wire with the others.

#### Cable data

For more detailed information about the transfer rate, bus length or cable requirements for the respective interfaces/buses, see ["Cable data" on page 285](#).

#### 4.2.4.2.3.3 CAN bus interface - Pinout

The CAN bus interface on the system unit is referred to as "IFx".

| CAN bus - IFx <sup>1)2)</sup> |               |
|-------------------------------|---------------|
| Variant                       | 10-pin, male  |
| Galvanic isolation            | No            |
| Transfer rate                 | Max. 1 Mbit/s |
| Bus length                    | Max. 1000 m   |
| Pin                           | Pinout        |
| 1                             | -             |
| 2                             | Shield        |
| 3                             | -             |
| 4                             | -             |
| 5                             | CAN H         |
| 6                             | CAN L         |
| 7                             | CAN GND       |
| 8                             | -             |
| 9                             | -             |
| 10                            | -             |

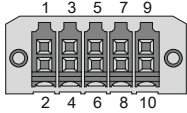

- 1) The interfaces, etc. available on the device or module have been numbered for the purpose of clear differentiation. This numbering may deviate from the numbering used by the respective operating system, however.
- 2) This interface can only be used in Automation Runtime and is displayed as IF3 in Automation Studio / Automation Runtime. It is not a "PC interface" and therefore not displayed in BIOS.

#### CAN driver settings

The baud rate can be set either with "predefined values" or via the "bit timing register".

For additional information, see Automation Help.

## Technical data

| Bit timing register 0 | Bit timing register 1 | Baud rate   |
|-----------------------|-----------------------|-------------|
| 00h                   | 14h                   | 1000 kbit/s |
| 80h or 00h            | 1Ch                   | 500 kbit/s  |
| 81h or 01h            | 1Ch                   | 250 kbit/s  |
| 83h or 03h            | 1Ch                   | 125 kbit/s  |
| 84h or 04h            | 1Ch                   | 100 kbit/s  |
| 89h or 09h            | 1Ch                   | 50 kbit/s   |

### Cable data

For more detailed information about the transfer rate, bus length or cable requirements for the respective interfaces/buses, see ["Cable data" on page 285](#).

### Terminating resistor

A terminating resistor is integrated on the interface option. It is switched on or off for the CAN bus interface with a switch. LED status indicator L1 indicates the current state:

- ON: Activated
- OFF (default): Switched off

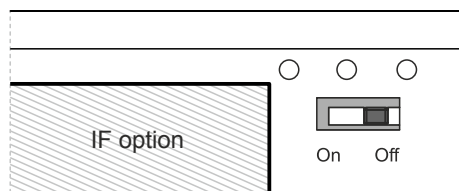

#### 4.2.4.2.3.4 LED status indicators

The LEDs of the interface option are located near the ETH1 interface.

| LED status indicators |           |          |  |
|-----------------------|-----------|----------|--|
| LED                   | Color     | Status   | Explanation  |
| L1                    | Yellow    | On       | The CAN bus terminating resistor is switched on.   |
|                       |           | Off      | The CAN bus terminating resistor is switched off.  |
| L2                    | Green     | On       | POWERLINK link LED<br>A connection to a POWERLINK network exists.                              |
|                       |           | Blinking | POWERLINK link LED<br>Data is being transferred.   |
| L3                    | Green-Red | On       | POWERLINK status/error LED<br>See <a href="#">"LED "S/E" (status/error LED)" on page 287</a> . |
|                       |           | Off      | POWERLINK status/error LED<br>See <a href="#">"LED "S/E" (status/error LED)" on page 287</a> . |

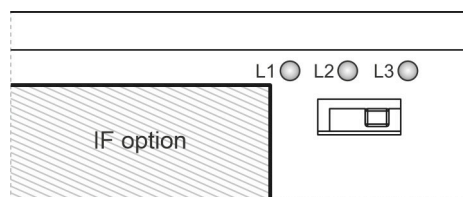

### POWERLINK commissioning and operation

For a description of the operating modes, status and node numbers of the POWERLINK interface(s), see ["LED "S/E" \(status/error LED\)" on page 287](#).

#### 4.2.4.2.4 Shielding

For the interfaces on the 10-pin female connector, the shield of the interfaces can be connected to pin *Shield* (pin 2) of the female connector.

In addition, there is a functional ground connection on the interface cover of the system unit and a screw point for cable shields that can also be used for the shielded cables.

#### 4.2.4.2.5 Driver support and firmware update

The driver is part of the Automation Runtime and the firmware is part of Automation Studio. The module is automatically brought up to this level.

To update the firmware contained in Automation Studio, a hardware upgrade must be performed (see [Project management / Workspace / Upgrades](#) in Automation Help).

### 4.2.4.3 5ACCIF01.FPLK-000

#### 4.2.4.3.1 General information

Interface option 5ACCIF01.FPLK-000 is equipped with 2 female RJ45 connectors; both connectors are connected to an integrated POWERLINK hub. In addition, 512 kB nvSRAM is installed.

With the integrated 2-port hub, a simple tree structure, daisy chain wiring or optional ring redundancy can be easily implemented without additional effort.

With poll-response chaining (PRC), the IF option offers a solution for the highest demands on response time and the shortest cycle times. Especially for central control tasks, poll-response chaining in combination with the B&R control system provides ideal performance.

- 1x POWERLINK interface for real-time communication
- 512 kB nvSRAM
- Integrated hub for economical wiring
- Configurable ring redundancy
- Poll-response chaining
- Compatible with APC2100/PPC2100 and APC2200/PPC2200

This interface option can only be operated with Automation Runtime.

#### Information:

**Ring redundancy in combination with poll-response chaining is not possible at the same time with this IF option.**

#### 4.2.4.3.2 Order data

| Order number      | Short description  | Figure  |
|-------------------|--|---|
|                   | <b>Interface options</b>   |   |
| 5ACCIF01.FPLK-000 | Interface card - 1x POWERLINK interface - Integrated 2-port hub - 512 kB nvSRAM - For APC2100/PPC2100/APC2200/PPC2200 - Only available with a new device |  |

#### 4.2.4.3.3 Technical data

#### Information:

The following specified characteristic data, features and limit values are only valid for this accessory and may differ from those of the complete system. The data specified for the complete system applies to the complete system in which an accessory is used.

| Order number                             | 5ACCIF01.FPLK-000   |
|--|---|
| <b>General information</b>               |   |
| LEDs                                     | L1, L2, L3  |
| B&R ID code                              | 0xE9BA  |
| <b>Certifications</b>                    |   |
| CE                                       | Yes   |
| UKCA                                     | Yes   |
| UL                                       | cULus E115267<br>Industrial control equipment   |
| HazLoc                                   | cULus HazLoc E180196<br>Industrial control equipment<br>for hazardous locations<br>Class I, Division 2, Groups ABCD, T4 |
| <b>Controller</b>                        |   |
| nvSRAM                                   |   |
| Size                                     | 512 kB  |
| Data retention                           | 20 years  |
| Read/Write endurance                     | Min. 1,000,000  |
| Battery-backed                           | No  |
| Remanent variables in power failure mode | 256 kB (for e.g. Automation Runtime, see Automation Help)   |

## Technical data

|                                 |  |
|---------------------------------|--|
| <b>Order number</b>             | <b>5ACCIF01.FPLK-000</b>                         |
| <b>Interfaces</b>               |  |
| POWERLINK                       |  |
| Quantity                        | 1 (integrated 2-port hub)                        |
| Type                            | Type 4, redundant <sup>1)</sup>                  |
| Variant                         | RJ45, shielded                                   |
| Transfer rate                   | 100 Mbit/s                                       |
| Transfer                        | 100BASE-TX                                       |
| Line length                     | Max. 100 m between two stations (segment length) |
| <b>Electrical properties</b>    |  |
| Power consumption               | 1.75 W   |
| <b>Operating conditions</b>     |  |
| Pollution degree per EN 61131-2 | Pollution degree 2                               |
| <b>Ambient conditions</b>       |  |
| Temperature                     |  |
| Operation                       | -20 to 55°C                                      |
| Storage                         | -20 to 60°C                                      |
| Transport                       | -20 to 60°C                                      |
| Relative humidity               |  |
| Operation                       | 5 to 90%, non-condensing                         |
| Storage                         | 5 to 95%, non-condensing                         |
| Transport                       | 5 to 95%, non-condensing                         |
| <b>Mechanical properties</b>    |  |
| Weight                          | 25 g   |

1) For additional information, see Automation Help (**Communication / POWERLINK / General information / Hardware - IF / LS**).

### 4.2.4.3.3.1 POWERLINK 1 interface - Pinout

The POWERLINK 1 interface on the system unit is referred to as "IF1".

| POWERLINK 1 - IF1 <sup>1)</sup> |   |                                   |
|---------------------------------|---|-----------------------------------|
| Variant                         | RJ45, female                                      |                                   |
| Wiring                          | S/STP (Cat 5e)                                    |                                   |
| Cable length                    | Max. 100 m (min. Cat 5e)                          |                                   |
| <b>LED status indicator (b)</b> | <b>On</b>   | <b>Off</b>                        |
| Green                           | See status/error LED.                             |                                   |
| <b>LED "Link" (a)</b>           | <b>On</b>   | <b>Active</b>                     |
| Yellow                          | Link (a connection to a POWERLINK network exists) | Blinking (data being transferred) |

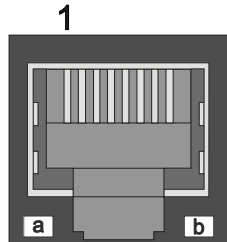

1) The interfaces, etc. available on the device or module have been numbered for the purpose of clear differentiation. This numbering may deviate from the numbering used by the respective operating system, however.

### 4.2.4.3.3.2 POWERLINK 2 interface - Pinout

The POWERLINK 2 interface on the system unit is referred to as "IFx".

| POWERLINK 2 - IFx <sup>1)</sup> |   |                                   |
|---------------------------------|---|-----------------------------------|
| Variant                         | RJ45, female                                      |                                   |
| Wiring                          | S/STP (Cat 5e)                                    |                                   |
| Cable length                    | Max. 100 m (min. Cat 5e)                          |                                   |
| <b>LED status indicator (b)</b> | <b>On</b>   | <b>Off</b>                        |
| Green                           | See status/error LED.                             |                                   |
| <b>LED "Link" (a)</b>           | <b>On</b>   | <b>Active</b>                     |
| Yellow                          | Link (a connection to a POWERLINK network exists) | Blinking (data being transferred) |

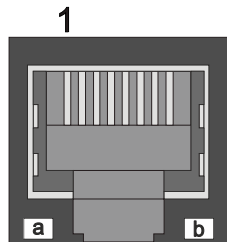

1) The interfaces, etc. available on the device or module have been numbered for the purpose of clear differentiation. This numbering may deviate from the numbering used by the respective operating system, however.

#### 4.2.4.3.3.3 LED status indicators L1, L2, L3

The LEDs of the interface option are located near the ETH1 interface.

| LED status indicators |           |          |   |
|-----------------------|-----------|----------|---|
| LED                   | Color     | Status   | Explanation   |
| L1                    | Green     | On       | POWERLINK 2 link LED<br>A connection to a POWERLINK network exists.           |
|                       |           | Blinking | POWERLINK 2 link LED<br>Data is being transferred.                            |
| L2                    | Green     | On       | POWERLINK 1 link LED<br>A connection to a POWERLINK network exists.           |
|                       |           | Blinking | POWERLINK 1 link LED<br>Data is being transferred.                            |
| L3                    | Green-Red | On       | POWERLINK status/error LED<br>See "LED "S/E" (status/error LED)" on page 287. |
|                       |           | Off      | POWERLINK status/error LED<br>See "LED "S/E" (status/error LED)" on page 287. |

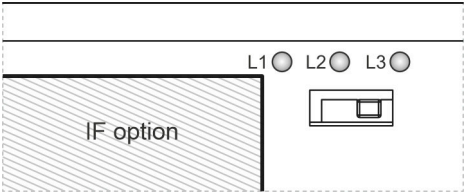

The diagram shows a rectangular panel with a hatched area labeled 'IF option'. To the right of this area are three circular LEDs labeled L1, L2, and L3. Below the LEDs is a small rectangular component, likely the interface option itself.

#### POWERLINK commissioning and operation

For a description of the operating modes, status and node numbers of the POWERLINK interface(s), see "LED "S/E" (status/error LED)" on page 287.

#### 4.2.4.3.4 Driver support and firmware update

The driver is part of the Automation Runtime and the firmware is part of Automation Studio. The module is automatically brought up to this level.

To update the firmware contained in Automation Studio, a hardware upgrade must be performed (see **Project management / Workspace / Upgrades** in Automation Help).

#### 4.2.4.4 5ACCIF01.FPLS-000

##### 4.2.4.4.1 General information

Interface option 5ACCIF01.FPLS-000 is equipped with a POWERLINK and RS232 interface. In addition, 32 kB FRAM is installed.

- 1x POWERLINK interface managing or controlled node
- 1x RS232 interface
- 32 kB FRAM
- Compatible with APC2100/PPC2100 and APC2200/PPC2200

##### 4.2.4.4.2 Order data

| Order number      | Short description  | Figure  |
|-------------------|--|---|
|                   | <b>Interface options</b>   |  |
| 5ACCIF01.FPLS-000 | Interface card - 1x RS232 interface - 1x POWERLINK interface - 32 kB FRAM - For APC2100/PPC2100/APC2200/PPC2200 - Only available with a new device |   |
|                   | <b>Optional accessories</b>  |   |
|                   | <b>Terminal blocks</b>   |   |
| 0TB1210.3100      | Connector 300 VDC - 10-pin female - Cage clamp terminal block - Protected against vibration by the screw flange                                    |   |

##### 4.2.4.4.3 Technical data

### Information:

The following specified characteristic data, features and limit values are only valid for this accessory and may differ from those of the complete system. The data specified for the complete system applies to the complete system in which an accessory is used.

| Order number                             | 5ACCIF01.FPLS-000   |
|--|---|
| <b>General information</b>               |   |
| LEDs                                     | L2, L3  |
| B&R ID code                              | 0xE540  |
| <b>Certifications</b>                    |   |
| CE                                       | Yes   |
| UKCA                                     | Yes   |
| UL                                       | cULus E115267<br>Industrial control equipment   |
| HazLoc                                   | cULus HazLoc E180196<br>Industrial control equipment<br>for hazardous locations<br>Class I, Division 2, Groups ABCD, T4                     |
| DNV                                      | Temperature: <b>B</b> (0 to 55°C)<br>Humidity: <b>B</b> (up to 100%)<br>Vibration: <b>A</b> (0.7 g)<br>EMC: <b>B</b> (bridge and open deck) |
| LR                                       | ENV3  |
| KR                                       | Yes   |
| ABS                                      | Yes   |
| BV                                       | <b>EC31B</b><br>Temperature: 5 - 55°C<br>Vibration: 0.7 g<br>EMC: Bridge and open deck  |
| <b>Controller</b>                        |   |
| FRAM                                     |   |
| Size                                     | 32 kB   |
| Data retention                           | 10 years  |
| Read/Write endurance                     | Min. 10 <sup>12</sup> times/byte  |
| Remanent variables in power failure mode | 32 kB (for e.g. Automation Runtime, see Automation Help)  |
| <b>Interfaces</b>                        |   |
| COM                                      |   |
| Quantity                                 | 1   |
| Type                                     | RS232, modem supported, not galvanically isolated   |
| Variant                                  | 10-pin, male  |
| UART                                     | 16550-compatible, 16-byte FIFO buffer   |
| Max. baud rate                           | 115 kbit/s  |

|                                 |  |
|---------------------------------|--|
| <b>Order number</b>             | <b>5ACCIF01.FPLS-000</b>                         |
| POWERLINK                       |  |
| Quantity                        | 1  |
| Type                            | Type 4 <sup>1)</sup>                             |
| Variant                         | RJ45, shielded                                   |
| Transfer rate                   | 100 Mbit/s                                       |
| Transfer                        | 100BASE-TX                                       |
| Line length                     | Max. 100 m between two stations (segment length) |
| <b>Electrical properties</b>    |  |
| Power consumption               | 1.5 W  |
| <b>Operating conditions</b>     |  |
| Pollution degree per EN 61131-2 | Pollution degree 2                               |
| <b>Ambient conditions</b>       |  |
| Temperature                     |  |
| Operation                       | -20 to 55°C                                      |
| Storage                         | -20 to 60°C                                      |
| Transport                       | -20 to 60°C                                      |
| Relative humidity               |  |
| Operation                       | 5 to 90%, non-condensing                         |
| Storage                         | 5 to 95%, non-condensing                         |
| Transport                       | 5 to 95%, non-condensing                         |
| <b>Mechanical properties</b>    |  |
| Weight                          | 25 g   |

1) For additional information, see Automation Help (**Communication / POWERLINK / General information / Hardware - IF / LS**).

#### 4.2.4.4.3.1 POWERLINK interface - Pinout

The POWERLINK interface on the system unit is referred to as "IF1".

| POWERLINK - IF1 <sup>1)2)</sup> |   |                                   |
|---------------------------------|---|-----------------------------------|
| Variant                         | RJ45, female                                      |                                   |
| Wiring                          | S/STP (Cat 5e)                                    |                                   |
| Cable length                    | Max. 100 m (min. Cat 5e)                          |                                   |
| <b>LED status indicator (b)</b> | <b>On</b>   | <b>Off</b>                        |
| Green                           | See status/error LED.                             |                                   |
| <b>LED "Link" (a)</b>           | <b>On</b>   | <b>Active</b>                     |
| Yellow                          | Link (a connection to a POWERLINK network exists) | Blinking (data being transferred) |

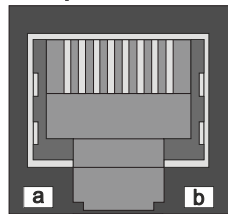

- 1) The interfaces, etc. available on the device or module have been numbered for the purpose of clear differentiation. This numbering may deviate from the numbering used by the respective operating system, however.
- 2) In Automation Studio / Automation Runtime, this interface is referred to as IF1.

#### 4.2.4.4.3.2 Serial interface COMA - Pinout

Serial interface COMA on the system unit is referred to as "IFx".

| Serial interface COMA - IFx <sup>1)2)3)</sup> |                                       |  |
|---|---------------------------------------|--|
| RS232   |                                       |  |
| Variant                                       | 10-pin, male                          |  |
| Type  | RS232, modem supported                |  |
| Galvanic isolation                            | No                                    |  |
| UART  | 16550-compatible, 16-byte FIFO buffer |  |
| Transfer rate                                 | Max. 115 kbit/s                       |  |
| Bus length                                    | Max. 15 m                             |  |
| <b>Pin</b>                                    | <b>Pinout</b>                         |  |
| 1   | DCD                                   |  |
| 2   | DSR                                   |  |
| 3   | RXD                                   |  |
| 4   | RTS                                   |  |
| 5   | TXD                                   |  |
| 6   | CTS                                   |  |
| 7   | DTR                                   |  |
| 8   | RI                                    |  |
| 9   | GND                                   |  |
| 10  | Shield                                |  |

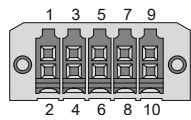

- 1) The interfaces, etc. available on the device or module have been numbered for the purpose of clear differentiation. This numbering may deviate from the numbering used by the respective operating system, however.
- 2) This interface (if available) is automatically enabled in BIOS as COMA with default addresses I/O:3F8h and IRQ:4.
- 3) In Automation Studio / Automation Runtime, this interface is referred to as IF5.

## Cable data

For more detailed information about the transfer rate, bus length or cable requirements for the respective interfaces/buses, see "Cable data" on page 285.

### 4.2.4.4.3 LED status indicators L2, L3

The LEDs of the interface option are located near the ETH1 interface.

| LED status indicators |           |          |   |
|-----------------------|-----------|----------|---|
| LED                   | Color     | Status   | Explanation   |
| L1                    |           |          | Not connected   |
| L2                    | Green     | On       | POWERLINK link LED<br>A connection to a POWERLINK network exists.             |
|                       |           | Blinking | POWERLINK link LED<br>Data is being transferred.                              |
| L3                    | Green-Red | On       | POWERLINK status/error LED<br>See "LED "S/E" (status/error LED)" on page 287. |
|                       |           | Off      | POWERLINK status/error LED<br>See "LED "S/E" (status/error LED)" on page 287. |

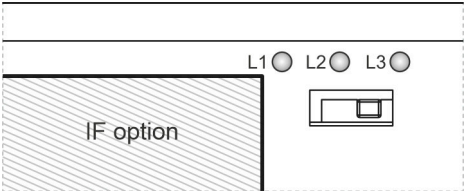

## POWERLINK commissioning and operation

For a description of the operating modes, status and node numbers of the POWERLINK interface(s), see "LED "S/E" (status/error LED)" on page 287.

### 4.2.4.4.4 Shielding

For the interfaces on the 10-pin female connector, the shield of the interfaces can be connected to pin *Shield* (pin 2) of the female connector.

In addition, there is a functional ground connection on the interface cover of the system unit and a screw point for cable shields that can also be used for the shielded cables.

### 4.2.4.4.5 Driver support and firmware update

Drivers for approved operating systems are available for download in the Downloads section of the B&R website ([www.br-automation.com](http://www.br-automation.com)) (if required and not already included in the operating system).

Approved operating systems:

- Automation Runtime
- Linux for B&R
- Windows 10
- Windows Embedded 8.1 Industry
- Windows 7
- Windows Embedded Standard 7

### Automation Runtime / B&R Hypervisor (RTOS)

The driver is part of the Automation Runtime and the firmware is part of Automation Studio. The module is automatically brought up to this level.

To update the firmware contained in Automation Studio, a hardware upgrade must be performed (see **Project management / Workspace / Upgrades** in Automation Help).

All interfaces of the interface option are supported in Automation Runtime / B&R Hypervisor.

### General purpose operating system (GPOS)

If this interface option is used with a GPOS, only operation of the serial port(s) is supported and the firmware update function cannot be used.

### 4.2.4.5 5ACCIF01.FPLS-001

#### 4.2.4.5.1 General information

Interface option 5ACCIF01.FPLS-001 is equipped with a POWERLINK and RS232 interface. In addition, 512 kB nvSRAM is installed.

- 1x POWERLINK interface managing or controlled node
- 1x RS232 interface
- 512 kB nvSRAM
- Compatible with APC2100/PPC2100 and APC2200/PPC2200

#### 4.2.4.5.2 Order data

| Order number      | Short description   | Figure  |
|-------------------|---|---|
|                   | <b>Interface options</b>  |  |
| 5ACCIF01.FPLS-001 | Interface card - 1x RS232 interface - 1x POWERLINK interface - 512 kB nvSRAM - For APC2100/PPC2100/APC2200/PPC2200 - Only available with a new device |   |
|                   | <b>Optional accessories</b>   |   |
|                   | <b>Terminal blocks</b>  |   |
| 0TB1210.3100      | Connector 300 VDC - 10-pin female - Cage clamp terminal block - Protected against vibration by the screw flange                                       |   |

#### 4.2.4.5.3 Technical data

### Information:

The following specified characteristic data, features and limit values are only valid for this accessory and may differ from those of the complete system. The data specified for the complete system applies to the complete system in which an accessory is used.

| Order number                             | 5ACCIF01.FPLS-001   |
|--|---|
| <b>General information</b>               |   |
| LEDs                                     | L2, L3  |
| B&R ID code                              | 0xE9B9  |
| <b>Certifications</b>                    |   |
| CE                                       | Yes   |
| UKCA                                     | Yes   |
| UL                                       | cULus E115267<br>Industrial control equipment   |
| HazLoc                                   | cULus HazLoc E180196<br>Industrial control equipment<br>for hazardous locations<br>Class I, Division 2, Groups ABCD, T4                     |
| DNV                                      | Temperature: <b>B</b> (0 to 55°C)<br>Humidity: <b>B</b> (up to 100%)<br>Vibration: <b>A</b> (0.7 g)<br>EMC: <b>B</b> (bridge and open deck) |
| LR                                       | ENV3  |
| ABS                                      | Yes   |
| BV                                       | <b>EC31B</b><br>Temperature: 5 - 55°C<br>Vibration: 0.7 g<br>EMC: Bridge and open deck  |
| <b>Controller</b>                        |   |
| nvSRAM                                   |   |
| Size                                     | 512 kB  |
| Data retention                           | 20 years  |
| Read/Write endurance                     | Min. 1,000,000  |
| Battery-backed                           | No  |
| Remanent variables in power failure mode | 256 kB (for e.g. Automation Runtime, see Automation Help)   |
| <b>Interfaces</b>                        |   |
| COM                                      |   |
| Quantity                                 | 1   |
| Type                                     | RS232, modem supported, not galvanically isolated   |
| Variant                                  | 10-pin, male  |
| UART                                     | 16550-compatible, 16-byte FIFO buffer   |
| Max. baud rate                           | 115 kbit/s  |

## Technical data

|                                 |  |
|---------------------------------|--|
| <b>Order number</b>             | <b>5ACCIF01.FPLS-001</b>                         |
| POWERLINK                       |  |
| Quantity                        | 1  |
| Type                            | Type 4 <sup>1)</sup>                             |
| Variant                         | RJ45, shielded                                   |
| Transfer rate                   | 100 Mbit/s                                       |
| Transfer                        | 100BASE-TX                                       |
| Line length                     | Max. 100 m between two stations (segment length) |
| <b>Electrical properties</b>    |  |
| Power consumption               | 1.5 W  |
| <b>Operating conditions</b>     |  |
| Pollution degree per EN 61131-2 | Pollution degree 2                               |
| <b>Ambient conditions</b>       |  |
| Temperature                     |  |
| Operation                       | -20 to 55°C                                      |
| Storage                         | -20 to 60°C                                      |
| Transport                       | -20 to 60°C                                      |
| Relative humidity               |  |
| Operation                       | 5 to 90%, non-condensing                         |
| Storage                         | 5 to 95%, non-condensing                         |
| Transport                       | 5 to 95%, non-condensing                         |
| <b>Mechanical properties</b>    |  |
| Weight                          | 25 g   |

1) For additional information, see Automation Help (**Communication / POWERLINK / General information / Hardware - IF / LS**).

### 4.2.4.5.3.1 POWERLINK interface - Pinout

The POWERLINK interface on the system unit is referred to as "IF1".

| POWERLINK - IF1 <sup>1)2)</sup> |   |                                   |
|---------------------------------|---|-----------------------------------|
| Variant                         | RJ45, female                                      |                                   |
| Wiring                          | S/STP (Cat 5e)                                    |                                   |
| Cable length                    | Max. 100 m (min. Cat 5e)                          |                                   |
| <b>LED status indicator (b)</b> | <b>On</b>   | <b>Off</b>                        |
| Green                           | See status/error LED.                             |                                   |
| <b>LED "Link" (a)</b>           | <b>On</b>   | <b>Off</b>                        |
| Yellow                          | Link (a connection to a POWERLINK network exists) | Blinking (data being transferred) |

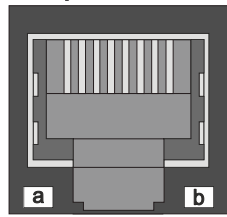

1) The interfaces, etc. available on the device or module have been numbered for the purpose of clear differentiation. This numbering may deviate from the numbering used by the respective operating system, however.

2) In Automation Studio / Automation Runtime, this interface is referred to as IF1.

### 4.2.4.5.3.2 Serial interface COMA - Pinout

Serial interface COMA on the system unit is referred to as "IFx".

| Serial interface COMA - IFx <sup>1)2)3)</sup> |                                       |               |
|---|---------------------------------------|---------------|
| <b>RS232</b>                                  |                                       |               |
| Variant                                       | 10-pin, male                          |               |
| Type  | RS232, modem supported                |               |
| Galvanic isolation                            | No                                    |               |
| UART  | 16550-compatible, 16-byte FIFO buffer |               |
| Transfer rate                                 | Max. 115 kbit/s                       |               |
| Bus length                                    | Max. 15 m                             |               |
|   | <b>Pin</b>                            | <b>Pinout</b> |
|   | 1                                     | DCD           |
|   | 2                                     | DSR           |
|   | 3                                     | RXD           |
|   | 4                                     | RTS           |
|   | 5                                     | TXD           |
|   | 6                                     | CTS           |
|   | 7                                     | DTR           |
|   | 8                                     | RI            |
|   | 9                                     | GND           |
|   | 10                                    | Shield        |

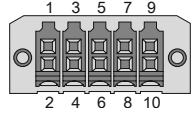

1) The interfaces, etc. available on the device or module have been numbered for the purpose of clear differentiation. This numbering may deviate from the numbering used by the respective operating system, however.

2) This interface (if available) is automatically enabled in BIOS as COMA with default addresses I/O:3F8h and IRQ:4.

3) In Automation Studio / Automation Runtime, this interface is referred to as IF5.

**Cable data**

For more detailed information about the transfer rate, bus length or cable requirements for the respective interfaces/buses, see "Cable data" on page 285.

**4.2.4.5.3 LED status indicators L2, L3**

The LEDs of the interface option are located near the ETH1 interface.

| LED status indicators |           |          |   |
|-----------------------|-----------|----------|---|
| LED                   | Color     | Status   | Explanation   |
| L1                    |           |          | Not connected   |
| L2                    | Green     | On       | POWERLINK link LED<br>A connection to a POWERLINK network exists.             |
|                       |           | Blinking | POWERLINK link LED<br>Data is being transferred.                              |
| L3                    | Green-Red | On       | POWERLINK status/error LED<br>See "LED "S/E" (status/error LED)" on page 287. |
|                       |           | Off      | POWERLINK status/error LED<br>See "LED "S/E" (status/error LED)" on page 287. |

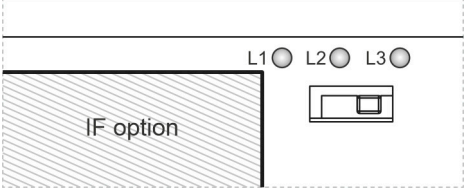

The diagram shows a rectangular area labeled 'IF option' with a hatched pattern. To its right, three LEDs are shown, labeled L1, L2, and L3 from left to right. L1 is a small circle, L2 is a larger circle, and L3 is a small circle. Below the LEDs is a small rectangular component, possibly a switch or connector.

**POWERLINK commissioning and operation**

For a description of the operating modes, status and node numbers of the POWERLINK interface(s), see "LED "S/E" (status/error LED)" on page 287.

**4.2.4.5.4 Shielding**

For the interfaces on the 10-pin female connector, the shield of the interfaces can be connected to pin *Shield* (pin 2) of the female connector.

In addition, there is a functional ground connection on the interface cover of the system unit and a screw point for cable shields that can also be used for the shielded cables.

**4.2.4.5.5 Driver support and firmware update**

Drivers for approved operating systems are available for download in the Downloads section of the B&R website ([www.br-automation.com](http://www.br-automation.com)) (if required and not already included in the operating system).

Approved operating systems:

- Automation Runtime
- Linux for B&R
- Windows 10
- Windows Embedded 8.1 Industry
- Windows 7
- Windows Embedded Standard 7

**Automation Runtime / B&R Hypervisor (RTOS)**

The driver is part of the Automation Runtime and the firmware is part of Automation Studio. The module is automatically brought up to this level.

To update the firmware contained in Automation Studio, a hardware upgrade must be performed (see **Project management / Workspace / Upgrades** in Automation Help).

All interfaces of the interface option are supported in Automation Runtime / B&R Hypervisor.

**General purpose operating system (GPOS)**

If this interface option is used with a GPOS, only operation of the serial port(s) is supported and the firmware update function cannot be used.

#### 4.2.4.6 5ACCIF01.FPSC-000

##### 4.2.4.6.1 General information

Interface option 5ACCIF01.FPSC-000 is equipped with a POWERLINK, RS232 and CAN bus master interface. In addition, 32 kB FRAM is installed.

- 1x POWERLINK interface managing or controlled node
- 1x CAN bus master interface
- 1x RS232 interface
- 32 kB FRAM
- Compatible with APC2100/PPC2100 and APC2200/PPC2200

This interface option can only be operated with Automation Runtime.

##### 4.2.4.6.2 Order data

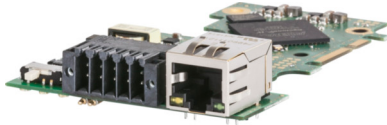
| Order number      | Short description  | Figure  |
|-------------------|--|---|
| 5ACCIF01.FPSC-000 | <b>Interface options</b><br>Interface card - 1x RS232 interface - 1x CAN interface - 1x POWERLINK interface - 32 kB FRAM - For APC2100/PPC2100/ APC2200/PPC2200 - Only available with a new device |  |
|                   | <b>Optional accessories</b>  |   |
|                   | <b>Terminal blocks</b>   |   |
| 0TB1210.3100      | Connector 300 VDC - 10-pin female - Cage clamp terminal block - Protected against vibration by the screw flange  |   |

##### 4.2.4.6.3 Technical data

### Information:

The following specified characteristic data, features and limit values are only valid for this accessory and may differ from those of the complete system. The data specified for the complete system applies to the complete system in which an accessory is used.

| Order number                             | 5ACCIF01.FPSC-000   |
|--|---|
| <b>General information</b>               |   |
| LEDs                                     | L1, L2, L3  |
| B&R ID code                              | 0xE53F  |
| <b>Certifications</b>                    |   |
| CE                                       | Yes   |
| UKCA                                     | Yes   |
| UL                                       | cULus E115267<br>Industrial control equipment   |
| HazLoc                                   | cULus HazLoc E180196<br>Industrial control equipment<br>for hazardous locations<br>Class I, Division 2, Groups ABCD, T4                     |
| DNV                                      | Temperature: <b>B</b> (0 to 55°C)<br>Humidity: <b>B</b> (up to 100%)<br>Vibration: <b>A</b> (0.7 g)<br>EMC: <b>B</b> (bridge and open deck) |
| LR                                       | ENV3  |
| KR                                       | Yes   |
| ABS                                      | Yes   |
| BV                                       | <b>EC31B</b><br>Temperature: 5 - 55°C<br>Vibration: 0.7 g<br>EMC: Bridge and open deck  |
| <b>Controller</b>                        |   |
| <b>FRAM</b>                              |   |
| Size                                     | 32 kB   |
| Data retention                           | 10 years  |
| Read/Write endurance                     | Min. 10 <sup>12</sup> times/byte  |
| Remanent variables in power failure mode | 32 kB<br>(for e.g. Automation Runtime, see Automation Help)   |
| <b>Interfaces</b>                        |   |
| <b>COM</b>                               |   |
| Quantity                                 | 1   |
| Type                                     | RS232, modem not supported, not galvanically isolated   |
| Variant                                  | 10-pin, male  |
| UART                                     | 16550-compatible, 16-byte FIFO buffer   |
| Max. baud rate                           | 115 kbit/s  |

|                                 |  |
|---------------------------------|--|
| <b>Order number</b>             | <b>5ACCIF01.FPSC-000</b>                         |
| <b>POWERLINK</b>                |  |
| Quantity                        | 1  |
| Type                            | Type 4 <sup>1)</sup>                             |
| Variant                         | RJ45, shielded                                   |
| Transfer rate                   | 100 Mbit/s                                       |
| Transfer                        | 100BASE-TX                                       |
| Line length                     | Max. 100 m between two stations (segment length) |
| <b>CAN</b>                      |  |
| Quantity                        | 1  |
| Variant                         | 10-pin, male, not galvanically isolated          |
| Transfer rate                   | Max. 1 Mbit/s                                    |
| Terminating resistor            |  |
| Type                            | Can be switched on and off with slide switch     |
| Default setting                 | Off  |
| <b>Electrical properties</b>    |  |
| Power consumption               | 1.75 W   |
| <b>Operating conditions</b>     |  |
| Pollution degree per EN 61131-2 | Pollution degree 2                               |
| <b>Ambient conditions</b>       |  |
| Temperature                     |  |
| Operation                       | -20 to 55°C                                      |
| Storage                         | -20 to 60°C                                      |
| Transport                       | -20 to 60°C                                      |
| Relative humidity               |  |
| Operation                       | 5 to 90%, non-condensing                         |
| Storage                         | 5 to 95%, non-condensing                         |
| Transport                       | 5 to 95%, non-condensing                         |
| <b>Mechanical properties</b>    |  |
| Weight                          | 25 g   |

1) For additional information, see Automation Help (**Communication / POWERLINK / General information / Hardware - IF / LS**).

#### 4.2.4.6.3.1 POWERLINK interface - Pinout

The POWERLINK interface on the system unit is referred to as "IF1".

| POWERLINK - IF1 <sup>1)2)</sup> |   |                                   |
|---------------------------------|---|-----------------------------------|
| Variant                         | RJ45, female                                      |                                   |
| Wiring                          | S/STP (Cat 5e)                                    |                                   |
| Cable length                    | Max. 100 m (min. Cat 5e)                          |                                   |
| <b>LED status indicator (b)</b> | <b>On</b>   | <b>Off</b>                        |
| Green                           | See status/error LED.                             |                                   |
| <b>LED "Link" (a)</b>           | <b>On</b>   | <b>Active</b>                     |
| Yellow                          | Link (a connection to a POWERLINK network exists) | Blinking (data being transferred) |

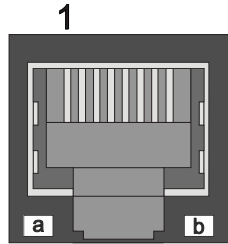

- 1) The interfaces, etc. available on the device or module have been numbered for the purpose of clear differentiation. This numbering may deviate from the numbering used by the respective operating system, however.
- 2) In Automation Studio / Automation Runtime, this interface is referred to as IF1.

#### 4.2.4.6.3.2 Serial interface COM - Pinout

Serial interface COM on the system unit is referred to as "IFx".

| Serial interface COM - IFx <sup>(1,2)</sup> |  |
|---|--|
| RS232                                       |  |
| Variant                                     | 10-pin, male                             |
| Type  | RS232, not modem supported               |
| Galvanic isolation                          | No                                       |
| UART  | 16550-compatible,<br>16-byte FIFO buffer |
| Transfer rate                               | Max. 115 kbit/s                          |
| Bus length                                  | Max. 15 m                                |
| Pin   | Pinout                                   |
| 1   | -  |
| 2   | Shield                                   |
| 3   | -  |
| 4   | -  |
| 5   | -  |
| 6   | -  |
| 7   | -  |
| 8   | COM GND                                  |
| 9   | RXD                                      |
| 10  | TXD                                      |

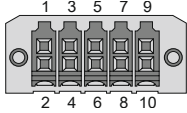

- 1) The interfaces, etc. available on the device or module have been numbered for the purpose of clear differentiation. This numbering may deviate from the numbering used by the respective operating system, however.
- 2) This interface can only be used in Automation Runtime and is displayed as IF5 in Automation Studio / Automation Runtime. It is not a "PC interface" and therefore not displayed in BIOS.

#### Cable data

For more detailed information about the transfer rate, bus length or cable requirements for the respective interfaces/buses, see ["Cable data" on page 285](#).

#### 4.2.4.6.3.3 CAN bus interface - Pinout

The CAN bus interface on the system unit is referred to as "IFx".

| CAN bus - IFx <sup>(1,2)</sup> |               |
|--------------------------------|---------------|
| Variant                        | 10-pin, male  |
| Galvanic isolation             | No            |
| Transfer rate                  | Max. 1 Mbit/s |
| Bus length                     | Max. 1000 m   |
| Pin                            | Pinout        |
| 1                              | -             |
| 2                              | Shield        |
| 3                              | -             |
| 4                              | -             |
| 5                              | CAN H         |
| 6                              | CAN L         |
| 7                              | CAN GND       |
| 8                              | -             |
| 9                              | -             |
| 10                             | -             |

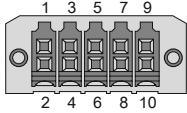

- 1) The interfaces, etc. available on the device or module have been numbered for the purpose of clear differentiation. This numbering may deviate from the numbering used by the respective operating system, however.
- 2) This interface can only be used in Automation Runtime and is displayed as IF3 in Automation Studio / Automation Runtime. It is not a "PC interface" and therefore not displayed in BIOS.

#### CAN driver settings

The baud rate can be set either with "predefined values" or via the "bit timing register".

For additional information, see Automation Help.

| Bit timing register 0 | Bit timing register 1 | Baud rate   |
|-----------------------|-----------------------|-------------|
| 00h                   | 14h                   | 1000 kbit/s |
| 80h or 00h            | 1Ch                   | 500 kbit/s  |
| 81h or 01h            | 1Ch                   | 250 kbit/s  |
| 83h or 03h            | 1Ch                   | 125 kbit/s  |
| 84h or 04h            | 1Ch                   | 100 kbit/s  |
| 89h or 09h            | 1Ch                   | 50 kbit/s   |

**Cable data**

For more detailed information about the transfer rate, bus length or cable requirements for the respective interfaces/buses, see "Cable data" on page 285.

**Terminating resistor**

A terminating resistor is integrated on the interface option. It is switched on or off for the CAN bus interface with a switch. LED status indicator L1 indicates the current state:

- ON: Activated
- OFF (default): Switched off

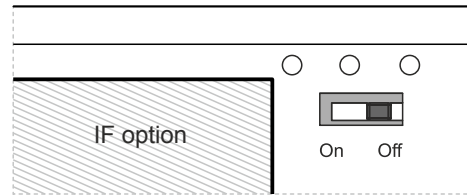

**4.2.4.6.3.4 LED status indicators L1, L2, L3**

The LEDs of the interface option are located near the ETH1 interface.

| LED status indicators |           |          |   |
|-----------------------|-----------|----------|---|
| LED                   | Color     | Status   | Explanation   |
| L1                    | Yellow    | On       | The CAN bus terminating resistor is switched on.                              |
|                       |           | Off      | The CAN bus terminating resistor is switched off.                             |
| L2                    | Green     | On       | POWERLINK link LED<br>A connection to a POWERLINK network exists.             |
|                       |           | Blinking | POWERLINK link LED<br>Data is being transferred.                              |
| L3                    | Green-Red | On       | POWERLINK status/error LED<br>See "LED "S/E" (status/error LED)" on page 287. |
|                       |           | Off      | POWERLINK status/error LED<br>See "LED "S/E" (status/error LED)" on page 287. |

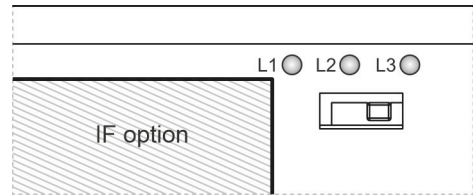

**POWERLINK commissioning and operation**

For a description of the operating modes, status and node numbers of the POWERLINK interface(s), see "LED "S/E" (status/error LED)" on page 287.

**4.2.4.6.4 Shielding**

For the interfaces on the 10-pin female connector, the shield of the interfaces can be connected to pin *Shield* (pin 2) of the female connector.

In addition, there is a functional ground connection on the interface cover of the system unit and a screw point for cable shields that can also be used for the shielded cables.

**4.2.4.6.5 Driver support and firmware update**

The driver is part of the Automation Runtime and the firmware is part of Automation Studio. The module is automatically brought up to this level.

To update the firmware contained in Automation Studio, a hardware upgrade must be performed (see **Project management / Workspace / Upgrades** in Automation Help).

### 4.2.4.7 5ACCIF01.FPSC-001

#### 4.2.4.7.1 General information

Interface option 5ACCIF01.FPSC-001 is equipped with a POWERLINK, RS232, CAN bus master and X2X Link master interface. In addition, 512 kB nvSRAM is installed.

- 1x POWERLINK interface managing or controlled node
- 1x CAN bus master interface
- 1x X2X Link master interface
- 1x RS232 interface
- 512 kB nvSRAM
- Compatible with APC2100/PC2100 and APC2200/PPC2200

This interface option can only be operated with Automation Runtime.

#### 4.2.4.7.2 Order data

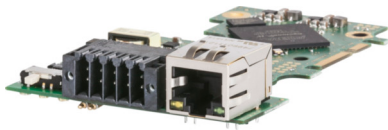
| Order number      | Short description  | Figure  |
|-------------------|--|---|
|                   | <b>Interface options</b>   |  |
| 5ACCIF01.FPSC-001 | Interface card - 1x RS232 interface - 1x CAN interface - 1x X2X Link Interface - 1x POWERLINK interface - 512 kB nvSRAM - For APC2100/PPC2100/APC2200/PPC2200 - Only available with a new device |   |
|                   | <b>Optional accessories</b>  |   |
|                   | <b>Terminal blocks</b>   |   |
| 0TB1210.3100      | Connector 300 VDC - 10-pin female - Cage clamp terminal block - Protected against vibration by the screw flange  |   |

#### 4.2.4.7.3 Technical data

### Information:

The following specified characteristic data, features and limit values are only valid for this accessory and may differ from those of the complete system. The data specified for the complete system applies to the complete system in which an accessory is used.

| Order number                             | 5ACCIF01.FPSC-001   |
|--|---|
| <b>General information</b>               |   |
| LEDs                                     | L1, L2, L3  |
| B&R ID code                              | 0xE9BC  |
| Certifications                           |   |
| CE                                       | Yes   |
| UKCA                                     | Yes   |
| UL                                       | cULus E115267<br>Industrial control equipment   |
| HazLoc                                   | cULus HazLoc E180196<br>Industrial control equipment<br>for hazardous locations<br>Class I, Division 2, Groups ABCD, T4                     |
| DNV                                      | Temperature: <b>B</b> (0 to 55°C)<br>Humidity: <b>B</b> (up to 100%)<br>Vibration: <b>A</b> (0.7 g)<br>EMC: <b>B</b> (bridge and open deck) |
| LR                                       | ENV3  |
| ABS                                      | Yes   |
| BV                                       | <b>EC31B</b><br>Temperature: 5 - 55°C<br>Vibration: 0.7 g<br>EMC: Bridge and open deck  |
| <b>Controller</b>                        |   |
| nvSRAM                                   |   |
| Size                                     | 512 kB  |
| Data retention                           | 20 years  |
| Read/Write endurance                     | Min. 1,000,000  |
| Battery-backed                           | No  |
| Remanent variables in power failure mode | 256 kB (for e.g. Automation Runtime, see Automation Help)   |
| <b>Interfaces</b>                        |   |
| COM                                      |   |
| Quantity                                 | 1   |
| Type                                     | RS232, modem not supported, not galvanically isolated   |
| Variant                                  | 10-pin, male  |
| UART                                     | 16550-compatible, 16-byte FIFO buffer   |
| Max. baud rate                           | 115 kbit/s  |

|                                 |  |
|---------------------------------|--|
| <b>Order number</b>             | <b>5ACCIF01.FPSC-001</b>                         |
| POWERLINK                       |  |
| Quantity                        | 1  |
| Type                            | Type 4 <sup>1)</sup>                             |
| Variant                         | RJ45, shielded                                   |
| Transfer rate                   | 100 Mbit/s                                       |
| Transfer                        | 100BASE-TX                                       |
| Line length                     | Max. 100 m between two stations (segment length) |
| CAN                             |  |
| Quantity                        | 1  |
| Variant                         | 10-pin, male, galvanically isolated              |
| Transfer rate                   | Max. 1 Mbit/s                                    |
| Terminating resistor            |  |
| Type                            | Can be switched on and off with slide switch     |
| Default setting                 | Off  |
| X2X                             |  |
| Type                            | X2X Link master                                  |
| Quantity                        | 1  |
| Variant                         | 10-pin, male, galvanically isolated              |
| <b>Electrical properties</b>    |  |
| Power consumption               | 2 W  |
| <b>Operating conditions</b>     |  |
| Pollution degree per EN 61131-2 | Pollution degree 2                               |
| <b>Ambient conditions</b>       |  |
| Temperature                     |  |
| Operation                       | -20 to 55°C                                      |
| Storage                         | -20 to 60°C                                      |
| Transport                       | -20 to 60°C                                      |
| Relative humidity               |  |
| Operation                       | 5 to 90%, non-condensing                         |
| Storage                         | 5 to 95%, non-condensing                         |
| Transport                       | 5 to 95%, non-condensing                         |
| <b>Mechanical properties</b>    |  |
| Weight                          | 25 g   |

1) For additional information, see Automation Help (**Communication / POWERLINK / General information / Hardware - IF / LS**).

#### 4.2.4.7.3.1 POWERLINK interface - Pinout

The POWERLINK interface on the system unit is referred to as "IF1".

| POWERLINK - IF1 <sup>1)2)</sup> |   |                                   |
|---------------------------------|---|-----------------------------------|
| Variant                         | RJ45, female                                      |                                   |
| Wiring                          | S/STP (Cat 5e)                                    |                                   |
| Cable length                    | Max. 100 m (min. Cat 5e)                          |                                   |
| <b>LED status indicator (b)</b> | <b>On</b>   | <b>Off</b>                        |
| Green                           | See status/error LED.                             |                                   |
| <b>LED "Link" (a)</b>           | <b>On</b>   | <b>Active</b>                     |
| Yellow                          | Link (a connection to a POWERLINK network exists) | Blinking (data being transferred) |

- 1) The interfaces, etc. available on the device or module have been numbered for the purpose of clear differentiation. This numbering may deviate from the numbering used by the respective operating system, however.
- 2) In Automation Studio / Automation Runtime, this interface is referred to as IF1.

#### 4.2.4.7.3.2 Serial interface COM - Pinout

Serial interface COM on the system unit is referred to as "IFx".

| Serial interface COM - IFx <sup>(1)(2)</sup> |  |
|--|--|
|  | <b>RS232</b>                             |
| Variant                                      | 10-pin, male                             |
| Type   | RS232, not modem supported               |
| Galvanic isolation                           | No                                       |
| UART   | 16550-compatible,<br>16-byte FIFO buffer |
| Transfer rate                                | Max. 115 kbit/s                          |
| Bus length                                   | Max. 15 m                                |
| Pin  | Pinout                                   |
| 1  | -  |
| 2  | Shield                                   |
| 3  | -  |
| 4  | -  |
| 5  | -  |
| 6  | -  |
| 7  | -  |
| 8  | COM GND                                  |
| 9  | RXD                                      |
| 10   | TXD                                      |

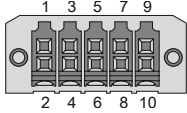

- 1) The interfaces, etc. available on the device or module have been numbered for the purpose of clear differentiation. This numbering may deviate from the numbering used by the respective operating system, however.
- 2) This interface can only be used in Automation Runtime and is displayed as IF5 in Automation Studio / Automation Runtime. It is not a "PC interface" and therefore not displayed in BIOS.

#### Cable data

For more detailed information about the transfer rate, bus length or cable requirements for the respective interfaces/buses, see ["Cable data" on page 285](#).

#### 4.2.4.7.3.3 CAN bus interface - Pinout

The CAN bus interface on the system unit is referred to as "IFx".

| CAN bus - IFx <sup>(1)(2)</sup> |               |
|---------------------------------|---------------|
| Variant                         | 10-pin, male  |
| Galvanic isolation              | Yes           |
| Transfer rate                   | Max. 1 Mbit/s |
| Bus length                      | Max. 1000 m   |
| Pin                             | Pinout        |
| 1                               | -             |
| 2                               | Shield        |
| 3                               | -             |
| 4                               | -             |
| 5                               | CAN H         |
| 6                               | CAN L         |
| 7                               | CAN GND       |
| 8                               | -             |
| 9                               | -             |
| 10                              | -             |

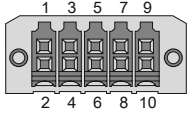

- 1) The interfaces, etc. available on the device or module have been numbered for the purpose of clear differentiation. This numbering may deviate from the numbering used by the respective operating system, however.
- 2) This interface can only be used in Automation Runtime and is displayed as IF3 in Automation Studio / Automation Runtime. It is not a "PC interface" and therefore not displayed in BIOS.

#### CAN driver settings

The baud rate can be set either with "predefined values" or via the "bit timing register".

For additional information, see Automation Help.

| Bit timing register 0 | Bit timing register 1 | Baud rate   |
|-----------------------|-----------------------|-------------|
| 00h                   | 14h                   | 1000 kbit/s |
| 80h or 00h            | 1Ch                   | 500 kbit/s  |
| 81h or 01h            | 1Ch                   | 250 kbit/s  |
| 83h or 03h            | 1Ch                   | 125 kbit/s  |
| 84h or 04h            | 1Ch                   | 100 kbit/s  |
| 89h or 09h            | 1Ch                   | 50 kbit/s   |

**Cable data**

For more detailed information about the transfer rate, bus length or cable requirements for the respective interfaces/buses, see "Cable data" on page 285.

**Terminating resistor**

A terminating resistor is integrated on the interface option. It is switched on or off for the CAN bus interface with a switch. LED status indicator L1 indicates the current state:

- ON: Activated
- OFF (default): Switched off

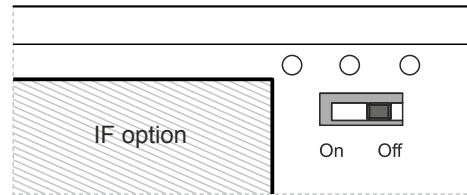

**4.2.4.7.3.4 X2X Link master interface - Pinout**

The X2X Link master interface on the system unit is referred to as "IFx".

| X2X Link master - IFx <sup>1)2)</sup> |                  |
|---------------------------------------|------------------|
| Variant                               | 10-pin, male     |
| Galvanic isolation                    | Yes              |
| Pin                                   | Pinout           |
| 1                                     | X2X              |
| 2                                     | Shield           |
| 3                                     | X2X <sub>I</sub> |
| 4                                     | X2X <sub>L</sub> |
| 5                                     | -                |
| 6                                     | -                |
| 7                                     | -                |
| 8                                     | -                |
| 9                                     | -                |
| 10                                    | -                |

The pinout diagram shows a 10-pin male connector. Pins 1, 3, 5, 7, and 9 are grouped together on the top side, and pins 2, 4, 6, 8, and 10 are grouped together on the bottom side. Pin 2 is the shield.

- 1) The interfaces, etc. available on the device or module have been numbered for the purpose of clear differentiation. This numbering may deviate from the numbering used by the respective operating system, however.
- 2) This interface can only be used in Automation Runtime and is displayed as IF2 in Automation Studio / Automation Runtime. It is not a "PC interface" and therefore not displayed in BIOS.

**4.2.4.7.3.5 LED status indicators L1, L2, L3**

The LEDs of the interface option are located near the ETH1 interface.

| LED status indicators |           |          |   |
|-----------------------|-----------|----------|---|
| LED                   | Color     | Status   | Explanation   |
| L1                    | Yellow    | On       | The CAN bus terminating resistor is switched on.                              |
|                       |           | Off      | The CAN bus terminating resistor is switched off.                             |
| L2                    | Green     | On       | POWERLINK link LED<br>A connection to a POWERLINK network exists.             |
|                       |           | Blinking | POWERLINK link LED<br>Data is being transferred.                              |
| L3                    | Green-Red | On       | POWERLINK status/error LED<br>See "LED "S/E" (status/error LED)" on page 287. |
|                       |           | Off      | POWERLINK status/error LED<br>See "LED "S/E" (status/error LED)" on page 287. |

The diagram shows a rectangular panel labeled 'IF option' on the left. To its right are three circular LEDs labeled L1, L2, and L3. Below the LEDs is a rectangular switch.

**POWERLINK commissioning and operation**

For a description of the operating modes, status and node numbers of the POWERLINK interface(s), see "LED "S/E" (status/error LED)" on page 287.

**4.2.4.7.4 Shielding**

For the interfaces on the 10-pin female connector, the shield of the interfaces can be connected to pin *Shield* (pin 2) of the female connector.

In addition, there is a functional ground connection on the interface cover of the system unit and a screw point for cable shields that can also be used for the shielded cables.

#### 4.2.4.7.5 Driver support and firmware update

The driver is part of the Automation Runtime and the firmware is part of Automation Studio. The module is automatically brought up to this level.

To update the firmware contained in Automation Studio, a hardware upgrade must be performed (see **Project management / Workspace / Upgrades** in Automation Help).

#### 4.2.4.8 5ACCIF01.FSS0-000

##### 4.2.4.8.1 General information

Interface option 5ACCIF01.FSS0-000 is equipped with 2 RS422/RS485 interfaces.

- 2x RS422/RS485 interfaces
- Compatible with APC2100/PPC2100 and APC2200/PPC2200

##### 4.2.4.8.2 Order data

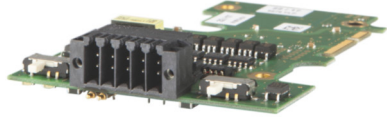
| Order number      | Short description  | Figure  |
|-------------------|--|---|
| 5ACCIF01.FSS0-000 | Interface card - 2x RS422/RS485 interface - For APC2100/PPC2100/APC2200/PPC2200 - Only available with a new device |  |
|                   | <b>Optional accessories</b>  |   |
|                   | <b>Terminal blocks</b>   |   |
| 0TB1210.3100      | Connector 300 VDC - 10-pin female - Cage clamp terminal block - Protected against vibration by the screw flange    |   |

##### 4.2.4.8.3 Technical data

### Information:

The following specified characteristic data, features and limit values are only valid for this accessory and may differ from those of the complete system. The data specified for the complete system applies to the complete system in which an accessory is used.

| Order number                    | 5ACCIF01.FSS0-000   |
|---------------------------------|---|
| <b>General information</b>      |   |
| LEDs                            | L2, L3  |
| B&R ID code                     | 0xED7B  |
| Certifications                  |   |
| CE                              | Yes   |
| UKCA                            | Yes   |
| UL                              | cULus E115267<br>Industrial control equipment   |
| HazLoc                          | cULus HazLoc E180196<br>Industrial control equipment<br>for hazardous locations<br>Class I, Division 2, Groups ABCD, T4                     |
| DNV                             | Temperature: <b>B</b> (0 to 55°C)<br>Humidity: <b>B</b> (up to 100%)<br>Vibration: <b>A</b> (0.7 g)<br>EMC: <b>B</b> (bridge and open deck) |
| LR                              | ENV3  |
| ABS                             | Yes   |
| BV                              | <b>EC31B</b><br>Temperature: 5 - 55°C<br>Vibration: 0.7 g<br>EMC: Bridge and open deck  |
| <b>Interfaces</b>               |   |
| COM                             |   |
| Quantity                        | 2   |
| Type                            | RS422/RS485, galvanically isolated  |
| Variant                         | 10-pin, male  |
| UART                            | 16550-compatible, 16-byte FIFO buffer   |
| Max. baud rate                  | 115 kbit/s  |
| Terminating resistor            |   |
| Type                            | Can be switched on and off with slide switch  |
| Default setting                 | Off   |
| <b>Electrical properties</b>    |   |
| Power consumption               | 1 W   |
| <b>Operating conditions</b>     |   |
| Pollution degree per EN 61131-2 | Pollution degree 2  |
| <b>Ambient conditions</b>       |   |
| Temperature                     |   |
| Operation                       | -20 to 60°C <sup>1)</sup>   |
| Storage                         | -20 to 60°C   |
| Transport                       | -20 to 60°C   |

## Technical data

|                              |                          |
|------------------------------|--------------------------|
| <b>Order number</b>          | <b>5ACCIF01.FSS0-000</b> |
| Relative humidity            |                          |
| Operation                    | 5 to 90%, non-condensing |
| Storage                      | 5 to 95%, non-condensing |
| Transport                    | 5 to 95%, non-condensing |
| <b>Mechanical properties</b> |                          |
| Weight                       | 25 g                     |

1) For detailed information, see the temperature tables in the user's manual.

### 4.2.4.8.3.1 Serial interface COM A - Pinout

Serial interface COM A on the system unit is referred to as "IFx".

| Serial interface COM A - IFx <sup>1)2)3)</sup> |  |
|--|--|
| RS422/RS485                                    |  |
| Variant  | 10-pin, male                             |
| Type   | RS422/RS485                              |
| Galvanic isolation                             | Yes                                      |
| UART   | 16550-compatible,<br>16-byte FIFO buffer |
| Transfer rate                                  | Max. 115 kbit/s                          |
| Bus length                                     | Max. 1200 m                              |
| Pin  | Pinout                                   |
| 1  | -  |
| 2  | -  |
| 3  | -  |
| 4  | -  |
| 5  | -  |
| 6  | COM GND                                  |
| 7  | TXD                                      |
| 8  | TXD\                                     |
| 9  | RXD                                      |
| 10   | RXD\                                     |

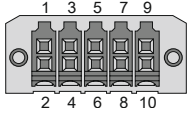

- 1) The interfaces, etc. available on the device or module have been numbered for the purpose of clear differentiation. This numbering may deviate from the numbering used by the respective operating system, however.
- 2) This interface (if available) is automatically enabled in BIOS as COM A with default addresses I/O:3F8h and IRQ:4.
- 3) This interface is displayed as IF7 in Automation Studio / Automation Runtime.

### Cable data

For more detailed information about the transfer rate, bus length or cable requirements for the respective interfaces/buses, see ["Cable data" on page 285](#).

### Operation as RS485 interface

The pins of the RS422 default interface (7, 8, 9 and 10) must be used for operation. To do this, connect the pins as shown.

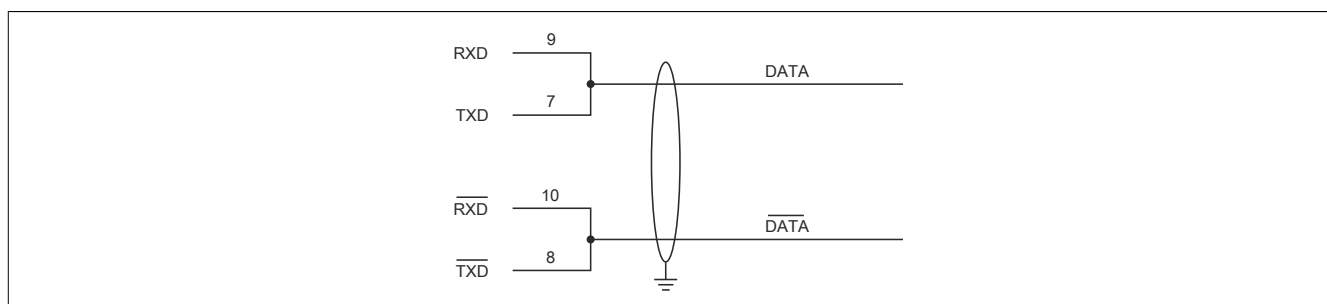

The RTS line must be switched by the driver for each transmission or reception; switching back does not take place automatically. This cannot be configured in Windows.

With long cable lengths, the voltage drop can result in greater potential differences between the bus devices, which can hinder communication. This can be improved by running the ground wire with the others.

The cable ends of an RS485 bus should be terminated (at least for longer cable lengths or higher transfer rates). Passive termination can normally be used by connecting the signal lines via a 120 Ω resistor at each of the two bus ends; see "Terminating resistor" for the IF card.

### 4.2.4.8.3.2 Serial interface COM D - Pinout

Serial interface COM D on the system unit is referred to as "IFx".

| Serial interface COMD - IFx <sup>1)2)3)</sup> |                                       |
|---|---------------------------------------|
| RS422/RS485                                   |                                       |
| Variant                                       | 10-pin, male                          |
| Type  | RS422/RS485                           |
| Galvanic isolation                            | Yes                                   |
| UART  | 16550-compatible, 16-byte FIFO buffer |
| Transfer rate                                 | Max. 115 kbit/s                       |
| Bus length                                    | Max. 1200 m                           |
| Pin   | Pinout                                |
| 1   | RXD                                   |
| 2   | RXD\                                  |
| 3   | TXD                                   |
| 4   | TXD\                                  |
| 5   | COM GND                               |
| 6   | -                                     |
| 7   | -                                     |
| 8   | -                                     |
| 9   | -                                     |
| 10  | -                                     |

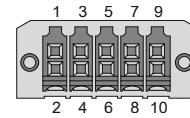

- 1) The interfaces, etc. available on the device or module have been numbered for the purpose of clear differentiation. This numbering may deviate from the numbering used by the respective operating system, however.
- 2) This interface (if available) is automatically enabled in BIOS as COM D with default addresses I/O:2E8h and IRQ:10.
- 3) This interface is displayed as IF8 in Automation Studio / Automation Runtime.

### Operating COM D as an RS485 interface

The pins of the RS422 default interface (1, 2, 3 and 4) must be used for operation. To do this, connect the pins as shown.

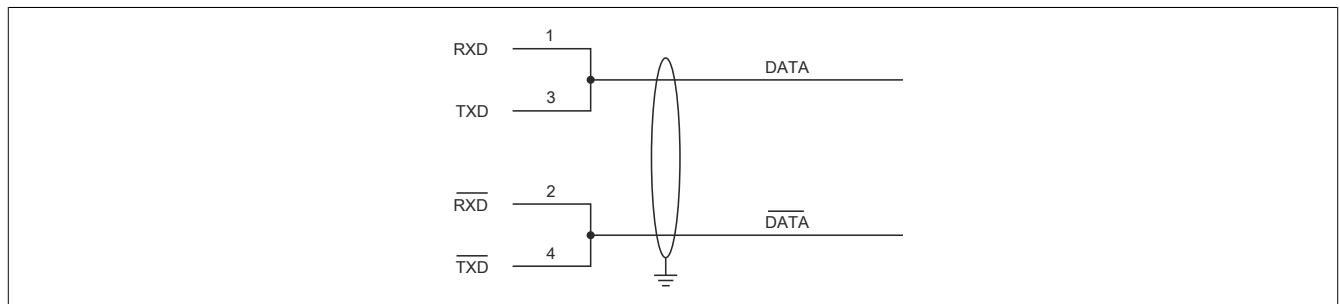

The RTS line must be switched by the driver for each transmission or reception; switching back does not take place automatically. This cannot be configured in Windows.

With long cable lengths, the voltage drop can result in greater potential differences between the bus devices, which can hinder communication. This can be improved by running the ground wire with the others.

The cable ends of an RS485 bus should be terminated (at least for longer cable lengths or higher transfer rates). Passive termination can normally be used by connecting the signal lines via a 120 Ω resistor at each of the two bus ends; see "Terminating resistor" for the IF card.

### 4.2.4.8.3.3 LED status indicators L2, L3

The LEDs of the interface option are located near the ETH1 interface.

| LED status indicators |        |        |   |
|-----------------------|--------|--------|---|
| LED                   | Color  | Status | Explanation                                     |
| L1                    |        |        | Not connected                                   |
| L2                    | Yellow | On     | The COM D terminating resistor is switched on.  |
|                       |        | Off    | The COM D terminating resistor is switched off. |
| L3                    | Yellow | On     | The COM A terminating resistor is switched on.  |
|                       |        | Off    | The COM A terminating resistor is switched off. |

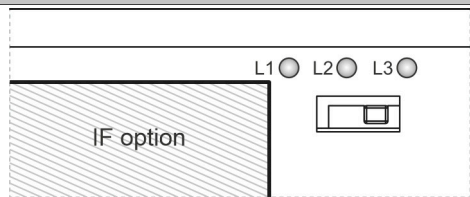

#### 4.2.4.8.3.4 Terminating resistor

One terminating resistor per COM is integrated on the interface option; they are located to the left and right of the RS422/RS485 interface. Both can be switched on or off with a switch. LED status indicators L2 and L3 (see "LED status indicators L2, L3" on page 161) indicate the state of the assigned terminating resistor:

- ON: Switched on
- OFF (default): Switched off

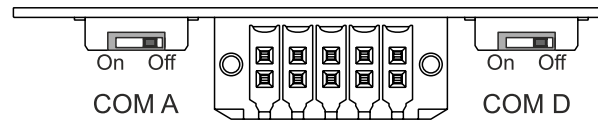

#### 4.2.4.8.3.5 Firmware

In order to ensure the functionality of the interface option, at least the following firmware version (MTCX) must be installed on the PC:

- Automation PC 2100: V1.10
- Panel PC 2100: V1.10

The firmware can be downloaded from the B&R website ([www.br-automation.com](http://www.br-automation.com)).

For information about upgrading the firmware, see section "Upgrading the firmware on the Panel PC 2100" on page 222.

#### 4.2.4.8.3.6 Hardware

In order to ensure the functionality of the interface option, the PC must have at least the following hardware revision:

- 5PPC2100.BY01-000 - Rev. I0 or later
- 5PPC2100.BY11-000 - Rev. H0 or later
- 5PPC2100.BY22-000 - Rev. I0 or later
- 5PPC2100.BY34-000 - Rev. I0 or later
- 5PPC2100.BY44-000 - Rev. J0 or later
- 5PPC2100.BY48-000 - Rev. D0 or later

#### 4.2.4.8.4 Shielding

For the interfaces on the 10-pin female connector, the shield of the interfaces can be connected to pin *Shield* (pin 2) of the female connector.

In addition, there is a functional ground connection on the interface cover of the system unit and a screw point for cable shields that can also be used for the shielded cables.

#### 4.2.4.8.5 Driver support

Drivers for approved operating systems are available for download in the Downloads section of the B&R website ([www.br-automation.com](http://www.br-automation.com)) (if required and not already included in the operating system).

Approved operating systems:

- Automation Runtime
- Linux for B&R
- Windows 10
- Windows Embedded 8.1 Industry
- Windows 7
- Windows Embedded Standard 7

## 4.2.4.9 5ACCIF01.ICAN-000

### 4.2.4.9.1 General information

Interface option 5ACCIF01.ICAN-000 is equipped with a CAN bus master interface.

- 1x CAN bus master interface
- Compatible with APC2100/PPC2100 and APC2200/PPC2200

### 4.2.4.9.2 Order data

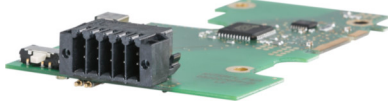
| Order number      | Short description  | Figure  |
|-------------------|--|---|
| 5ACCIF01.ICAN-000 | <b>Interface options</b><br>Interface card - 1x CAN interface - For APC2100/PPC2100/<br>APC2200/PPC2200 - Only available with a new device |  |
|                   | <b>Optional accessories</b>  |   |
|                   | <b>Terminal blocks</b>   |   |
| 0TB1210.3100      | Connector 300 VDC - 10-pin female - Cage clamp terminal block<br>- Protected against vibration by the screw flange                         |   |

### 4.2.4.9.3 Technical data

#### Information:

The following specified characteristic data, features and limit values are only valid for this accessory and may differ from those of the complete system. The data specified for the complete system applies to the complete system in which an accessory is used.

| Order number                    | 5ACCIF01.ICAN-000   |
|---------------------------------|---|
| <b>General information</b>      |   |
| LEDs                            | L1  |
| B&R ID code                     | 0xE9BB  |
| <b>Certifications</b>           |   |
| CE                              | Yes   |
| UKCA                            | Yes   |
| UL                              | cULus E115267<br>Industrial control equipment   |
| HazLoc                          | cULus HazLoc E180196<br>Industrial control equipment<br>for hazardous locations<br>Class I, Division 2, Groups ABCD, T4 |
| <b>Interfaces</b>               |   |
| CAN                             |   |
| Quantity                        | 1   |
| Controller                      | Bosch CC770 (compatible with Intel 82527 CAN controller)  |
| Variant                         | 10-pin, male, galvanically isolated   |
| Transfer rate                   | Max. 1 Mbit/s   |
| Terminating resistor            |   |
| Type                            | Can be switched on and off with slide switch  |
| Default setting                 | Off   |
| <b>Electrical properties</b>    |   |
| Power consumption               | 0.5 W   |
| <b>Operating conditions</b>     |   |
| Pollution degree per EN 61131-2 | Pollution degree 2  |
| <b>Ambient conditions</b>       |   |
| Temperature                     |   |
| Operation                       | -20 to 60°C <sup>1)</sup>   |
| Storage                         | -20 to 60°C   |
| Transport                       | -20 to 60°C   |
| Relative humidity               |   |
| Operation                       | 5 to 90%, non-condensing  |
| Storage                         | 5 to 95%, non-condensing  |
| Transport                       | 5 to 95%, non-condensing  |
| <b>Mechanical properties</b>    |   |
| Weight                          | 25 g  |

1) For detailed information, see the temperature tables in the user's manual.

### 4.2.4.9.3.1 CAN bus interface - Pinout

The CAN bus interface on the system unit is referred to as "IFx".

| CAN bus - IFx <sup>1)2)</sup> |               |
|-------------------------------|---------------|
| Variant                       | 10-pin, male  |
| Galvanic isolation            | Yes           |
| Transfer rate                 | Max. 1 Mbit/s |
| Bus length                    | Max. 1000 m   |
| Pin                           | Pinout        |
| 1                             | -             |
| 2                             | CAN shield    |
| 3                             | -             |
| 4                             | -             |
| 5                             | CAN H         |
| 6                             | CAN L         |
| 7                             | CAN GND       |
| 8                             | -             |
| 9                             | -             |
| 10                            | -             |

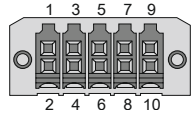

- 1) The interfaces, etc. available on the device or module have been numbered for the purpose of clear differentiation. This numbering may deviate from the numbering used by the respective operating system, however.
- 2) This interface (if available) is automatically enabled in BIOS as CAN with default addresses I/O:384h/385h and IRQ:10.

### I/O address and IRQ

| Resource    | Default setting         | Function  |
|-------------|-------------------------|---|
| I/O address | 384h (address register) | Defines the register number to be accessed.             |
|             | 385h (data register)    | Access to the register defined in the address register. |
| IRQ         | IRQ:10                  | Interrupt   |

### CAN driver settings

The baud rate can be set either with "predefined values" or via the "bit timing register".  
 For additional information about operation with Automation Runtime, see Automation Help.  
 For additional information about operation with approved GPOS, see the user's manual for the B&R CAN driver at [www.br-automation.com](http://www.br-automation.com).

| Bit timing register 0 | Bit timing register 1 | Baud rate   |
|-----------------------|-----------------------|-------------|
| 00h                   | 14h                   | 1000 kbit/s |
| 80h or 00h            | 1Ch                   | 500 kbit/s  |
| 81h or 01h            | 1Ch                   | 250 kbit/s  |
| 83h or 03h            | 1Ch                   | 125 kbit/s  |
| 84h or 04h            | 1Ch                   | 100 kbit/s  |
| 89h or 09h            | 1Ch                   | 50 kbit/s   |

### Terminating resistor

A terminating resistor is integrated on the interface option. It is switched on or off for the CAN bus interface with a switch. LED status indicator L1 indicates the current state:

- ON: Activated
- OFF (default): Switched off

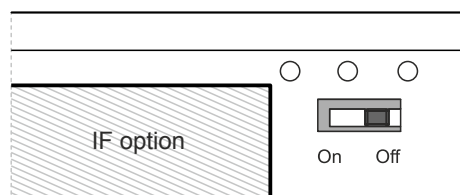

### 4.2.4.9.3.2 LED status indicator L1

The LEDs of the interface option are located near the ETH1 interface.

| LED status indicator |        |               |   |
|----------------------|--------|---------------|---|
| LED                  | Color  | Status        | Explanation                                       |
| L1                   | Yellow | On            | The CAN bus terminating resistor is switched on.  |
|                      |        | Off           | The CAN bus terminating resistor is switched off. |
| L2                   |        | Not connected |   |
| L3                   |        | Not connected |   |
|                      |        | -             |   |

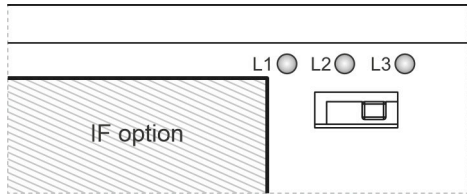

#### 4.2.4.9.3.3 Firmware

In order to ensure the functionality of the interface option, at least the following firmware version (MTCX) must be installed on the PC:

- Automation PC 2100: V1.06
- Panel PC 2100: V1.06

The firmware can be downloaded from the B&R website ([www.br-automation.com](http://www.br-automation.com)).

For information about upgrading the firmware, see section "Upgrading the firmware on the Panel PC 2100" on page 222.

#### 4.2.4.9.4 Shielding

For the interfaces on the 10-pin female connector, the shield of the interfaces can be connected to pin *Shield* (pin 2) of the female connector.

In addition, there is a functional ground connection on the interface cover of the system unit and a screw point for cable shields that can also be used for the shielded cables.

#### 4.2.4.9.5 Driver support

Drivers for approved operating systems are available for download in the Downloads section of the B&R website ([www.br-automation.com](http://www.br-automation.com)) (if required and not already included in the operating system).

Approved operating systems:

- Automation Runtime
- Linux for B&R
- Windows 10
- Windows Embedded 8.1 Industry
- Windows 7
- Windows Embedded Standard 7

#### 4.2.4.10 5ACCIF01.IS00-000

##### 4.2.4.10.1 General information

Interface option 5ACCIF01.IS00-000 is equipped with an RS232 interface.

- 1x RS232 interface
- Compatible with APC2100/PPC2100 and APC2200/PPC2200

##### 4.2.4.10.2 Order data

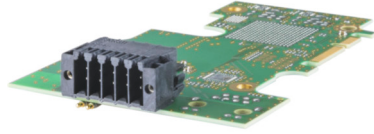
| Order number      | Short description   | Figure  |
|-------------------|---|---|
|                   | <b>Interface options</b>  |  |
| 5ACCIF01.IS00-000 | Interface card - 1x RS232 interface - For APC2100/PPC2100/ APC2200/PPC2200 - Only available with a new device   |   |
|                   | <b>Optional accessories</b>   |   |
|                   | <b>Terminal blocks</b>  |   |
| 0TB1210.3100      | Connector 300 VDC - 10-pin female - Cage clamp terminal block - Protected against vibration by the screw flange |   |

##### 4.2.4.10.3 Technical data

### Information:

The following specified characteristic data, features and limit values are only valid for these individual components and may differ from those of the complete system. The data specified for the complete system applies to the complete system in which an individual component is used.

| Order number                    | 5ACCIF01.IS00-000                                 |
|---------------------------------|---|
| <b>General information</b>      |   |
| LEDs                            | No  |
| B&R ID code                     | 0x2C43  |
| <b>Certifications</b>           |   |
| CE                              | Yes   |
| UKCA                            | Yes   |
| UL                              | cULus E115267<br>Industrial control equipment     |
| <b>Interfaces</b>               |   |
| <b>COM</b>                      |   |
| Quantity                        | 1   |
| Type                            | RS232, modem supported, not galvanically isolated |
| Variant                         | 10-pin, male                                      |
| UART                            | 16550-compatible, 16-byte FIFO buffer             |
| Max. baud rate                  | 115 kbit/s  |
| <b>Electrical properties</b>    |   |
| Power consumption               | Max. 0.5 W  |
| <b>Operating conditions</b>     |   |
| Pollution degree per EN 61131-2 | Pollution degree 2                                |
| <b>Ambient conditions</b>       |   |
| <b>Temperature</b>              |   |
| Operation                       | -20 to 55°C                                       |
| Storage                         | -20 to 60°C                                       |
| Transport                       | -20 to 60°C                                       |
| <b>Relative humidity</b>        |   |
| Operation                       | 5 to 90%, non-condensing                          |
| Storage                         | 5 to 95%, non-condensing                          |
| Transport                       | 5 to 95%, non-condensing                          |
| <b>Mechanical properties</b>    |   |
| Weight                          | Approx. 25 g                                      |

#### 4.2.4.10.3.1 Serial interface COMA - Pinout

Serial interface COMA on the system unit is referred to as "IFx".

| Serial interface COMA - IFx <sup>1)2)</sup> |  |
|---|--|
| RS232                                       |  |
| Variant                                     | 10-pin, male                             |
| Type  | RS232, modem supported                   |
| Galvanic isolation                          | No                                       |
| UART  | 16550-compatible,<br>16-byte FIFO buffer |
| Transfer rate                               | Max. 115 kbit/s                          |
| Bus length                                  | Max. 15 m                                |
| Pin   | Pinout                                   |
| 1   | DCD                                      |
| 2   | DSR                                      |
| 3   | RXD                                      |
| 4   | RTS                                      |
| 5   | TXD                                      |
| 6   | CTS                                      |
| 7   | DTR                                      |
| 8   | RI                                       |
| 9   | GND                                      |
| 10  | Shield                                   |

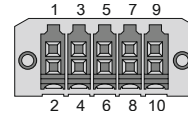

- 1) The interfaces, etc. available on the device or module have been numbered for the purpose of clear differentiation. This numbering may deviate from the numbering used by the respective operating system, however.
- 2) This interface (if available) is automatically enabled in BIOS as COMA with default addresses I/O:3F8h and IRQ:4.

#### Cable data

For more detailed information about the transfer rate, bus length or cable requirements for the respective interfaces/buses, see "Cable data" on page 285.

#### 4.2.4.10.4 Shielding

For the interfaces on the 10-pin female connector, the shield of the interfaces can be connected to pin *Shield* (pin 2) of the female connector.

In addition, there is a functional ground connection on the interface cover of the system unit and a screw point for cable shields that can also be used for the shielded cables.

#### 4.2.4.10.5 Driver support

Drivers for approved operating systems are available for download in the Downloads section of the B&R website ([www.br-automation.com](http://www.br-automation.com)) (if required and not already included in the operating system).

Approved operating systems:

- Linux for B&R
- Windows 10
- Windows Embedded 8.1 Industry
- Windows 7
- Windows Embedded Standard 7

#### 4.2.5 CFast cards

Detailed information about compatible CFast cards is available on the B&R website ([CFast cards](#)).

# 5 Installation and wiring

---

## 5.1 Basic information

**A damaged device has unpredictable properties and states. The unintentional installation or startup of a damaged device must be prevented. The damaged device must be marked as such and made inaccessible, or it must be returned for repairs immediately.**

### Unpacking

The following activities must be performed before unpacking the device:

- Check the packaging for visible transport damage.
- If transport damage is noticeable, document this immediately and submit a complaint. If possible, have the damage confirmed by the carrier/delivery service.
- Check the contents of the shipment for completeness and damage.
- If the contents of the packaging are incomplete, damaged or do not correspond to the order, the responsible sales office or B&R Headquarters must be informed immediately.
- The information in section "[Protection against electrostatic discharge](#)" on page 14 must be observed for unpacked devices and components.
- Keep the original packaging for further transport.

### Power supply

The following information is generally applicable and should be observed before performing any work on the device:

- The entire power supply must be disconnected before removing any covers or components from the device and installing or removing any accessories, hardware or cables.
- Remove the power cable from the device and from the power supply.
- All covers and components, accessories, hardware and cables must be installed or secured before the device is connected to the power supply and switched on.

### Caution!

**Energy regeneration is not permitted and can cause damage or the device to become defective. Built-in or connected peripheral devices (e.g. USB hubs) are not permitted to introduce any voltage into the device.**

### Installation

#### Information:

**Optional sets are available that contain all necessary tools for installation. For additional information about tool sets, see section "[Installation accessories](#)" on page 266.**

#### Before installation

The following activities and limitations must be observed before installing the device.

- Allow sufficient space for installation, operation and maintenance of the device.
- The device must be installed on a flat, clean and burr-free surface.
- The wall or control cabinet panel must be able to support four times the total weight of the device. If necessary, bracing must be attached to reinforce the mounting surface.

### Caution!

**If the load-bearing capacity of the mounting surface is insufficient, or if the fastening material is inadequate or incorrect, the device may fall and become damaged.**

- To avoid overheating, the device is not permitted to be placed near other heat sources.

### Information about the device's environment

- Observe the notes and regulations regarding the power supply and functional ground.
- Observe the specified bend radius when connecting cables.
- Ventilation openings are not permitted to be covered or blocked.
- The device is only permitted to be operated in closed rooms and not permitted to be exposed to direct sunlight.
- The climatic ambient conditions and environmental conditions must be taken into account – see ["Environmental properties"](#) on page 34.

### General installation instructions

- Inclined installation reduces the air convection through the device and thus the maximum permissible ambient temperature for operation. If there is sufficient external ventilation in an inclined mounting orientation, the maximum permissible ambient temperature must be checked in each individual case. Failure to do so may result in damage to the equipment and void the certifications and warranty for the device.
- When installing the device, the permissible mounting orientations must be observed - .
- The device must be installed in such a way that it can be optimally viewed by the user.
- The device must be installed in such a way that reflections on the screen are avoided as far as possible.
- When connecting installed or connected peripherals, follow the instructions in the peripheral device's documentation.

### Information about leak tightness

#### Warning!

**Failure to follow instructions can result in damage to property.**

- The gasket must be inspected before installation or reinstallation and at regular intervals according to the requirements of the operating environment.
- Replace the entire device if inspection reveals visible scratches, cracks, dirt deposits or excessive wear.
- Do not stretch the gasket unnecessarily.
- It is important to ensure that the gasket is correctly seated all around.
- The housing components must be secured using the specified tightening torque.

### Transport and storage

#### Information:

**Condensation may form under certain environmental conditions or rapid climatic changes. For improved acclimatization and to avoid damage, the device must be slowly adapted to the room temperature.**

When transporting at low temperatures or in the event of large temperature fluctuations, the collection of moisture in or on the device is not permitted. Moisture can cause short circuits in electrical circuits and damage the device.

If a device is transported or stored without packaging, all environmental influences such as shocks, vibrations, pressure and moisture have an unprotected effect on the device. Damaged packaging indicates that the device has been severely affected by environmental influences and may have been damaged.

This can result in malfunctions of the device, machine or system.

### Use of third-party products

If third-party devices or components are used, the relevant manufacturer's documentation must be observed. If limitations or interactions by or with third-party products are possible, this must be taken into account in the application.

### 5.1.1 Installing a Panel PC with an AP9x3 panel

The Panel PC 2100 with AP9x3 panel is installed in the installation cutout using retaining clips. The number of retaining clips depends on the panel.

The device must be installed on a flat, clean and burr-free surface since tightening screws on an uneven area can result in damage to the display or the ingress of dust and water.

#### Required tools:

- 2.5 mm hex screwdriver

The following AP9x3 panels are installed with retaining clips:

- 5AP923.1215-00
- 5AP923.1505-00
- 5AP923.1906-00
- 5AP933.156B-00
- 5AP933.185B-00
- 5AP933.215C-00
- 5AP933.240C-00

### Notice!

**All the included retaining clips and clamping blocks must be used during installation. Failure to do so can result in damage to property due to loss of leak tightness between the device and housing (pollution) or mechanical stress.**

#### Procedure

1. Check whether the supplied mounting screws (1) are screwed into the retaining clips (2). If this is not the case, then the mounting screws must be screwed into the retaining clips with a 2.5 mm hex screwdriver (A). The mounting screws are only permitted to be screwed in to the point where they do not project beyond the retaining clip (B).

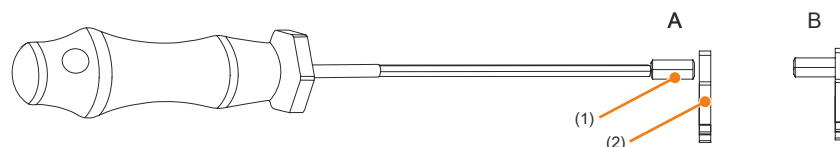

2. Insert the device into the prepared installation cutout (see "[Mounting orientations](#)" on page 28).
3. Install the retaining clips on the device. To do this, insert all retaining clips into the recesses (marked with orange circles) on the device.

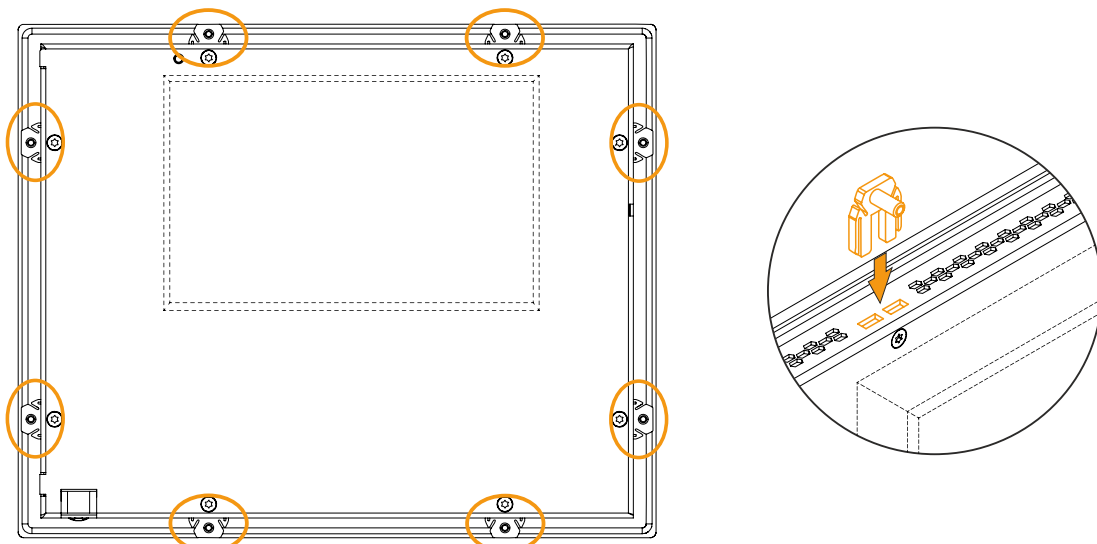

- Secure the retaining clips by alternately tightening the mounting screws with a 2.5 mm hex screwdriver (max. tightening torque 1 Nm).

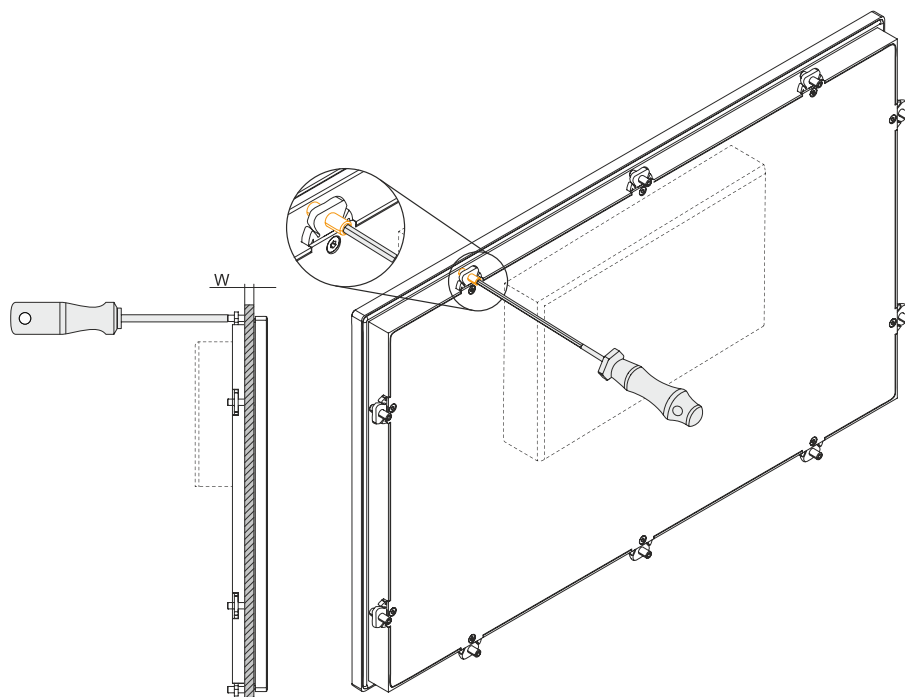

| Thickness of the wall or control cabinet | Minimum                                | Maximum |
|--|--|---------|
| W  | See "Mounting orientations" on page 28 |         |

## 5.1.2 Installing the Automation Panel 1000 with retaining clips

The Panel PC 2100 with AP1000 panel is installed in the installation cutout using retaining clips. The number of retaining clips depends on the panel.

The device must be installed on a flat, clean and burr-free surface since tightening screws on an uneven area can result in damage to the display or the ingress of dust and water.

### Required tools:

- 2.5 mm hex screwdriver

The following AP1000 panels are installed with retaining clips:

- 5AP11xx.0573-000
- 5AP11x0.0702-000
- 5AP11x0.101x-000
- 5AP1120.1043-000
- 5AP11x0.121E-0x0
- 5AP11x0.156x-00x
- 5AP1130.185C-000
- 5AP1180.1043-000

## Notice!

**All the included retaining clips and clamping blocks must be used during installation. Failure to do so can result in damage to property due to loss of leak tightness between the device and housing (pollution) or mechanical stress.**

### Procedure

1. Check whether the supplied mounting screws (1) are screwed into the retaining clips (2). If this is not the case, then the mounting screws must be screwed into the retaining clips with a 2.5 mm hex screwdriver (A). The mounting screws are only permitted to be screwed in to the point where they do not project beyond the retaining clip (B).

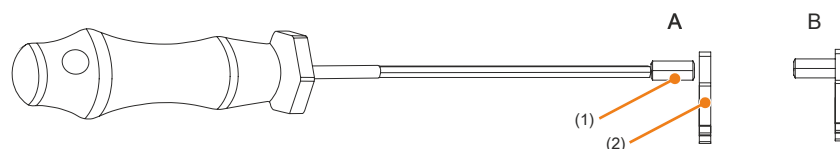

2. Insert the device into the prepared installation cutout (see "[Mounting orientations](#)" on page 28).
3. Install the retaining clips on the device. To do this, insert all retaining clips into the recesses (marked with orange circles) on the device.

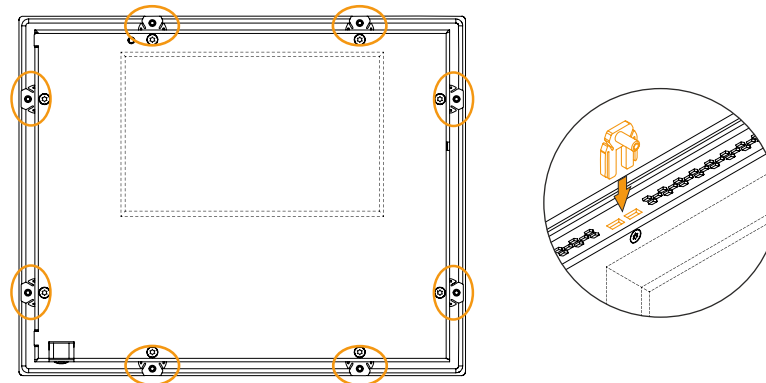

- Secure the retaining clips by alternately tightening the mounting screws with a 2.5 mm hex screwdriver (max. tightening torque 1 Nm).

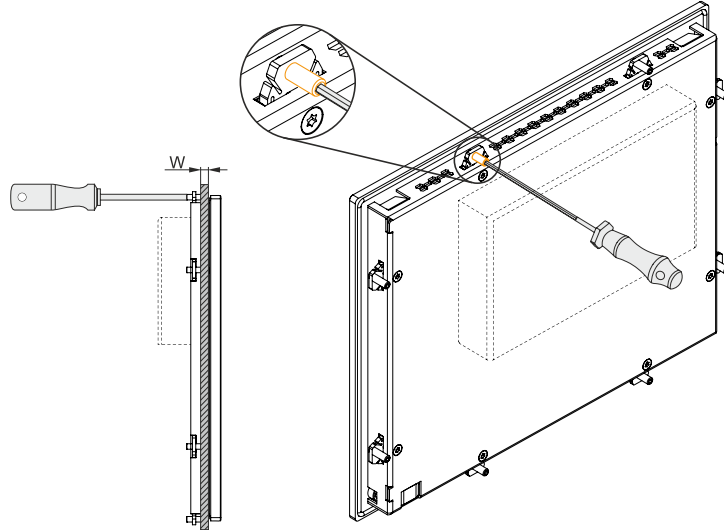

| Thickness of the wall or control cabinet | Minimum                                | Maximum |
|--|--|---------|
| W  | See "Mounting orientations" on page 28 |         |

### 5.1.3 Installing the Automation Panel 1000 with clamping blocks

The Panel PC 2100 with AP1000 panel is installed in the installation cutout using clamping blocks. The number of clamping blocks depends on the panel.

The device must be installed on a flat, clean and burr-free surface since tightening screws on an uneven area can result in damage to the display or the ingress of dust and water.

**Required tools:**

- 3.0 mm hex screwdriver

The following AP1000 panels are installed with clamping blocks:

- 5AP118x.1043-000
- 5AP1120.1214-000
- 5AP1120.1505-000
- 5AP118x.1505-000
- 5AP1120.1906-000

## Notice!

All the included retaining clips and clamping blocks must be used during installation. Failure to do so can result in damage to property due to loss of leak tightness between the device and housing (pollution) or mechanical stress.

**Procedure**

1. Insert the device into the prepared installation cutout (see ["Mounting orientations" on page 28](#)).

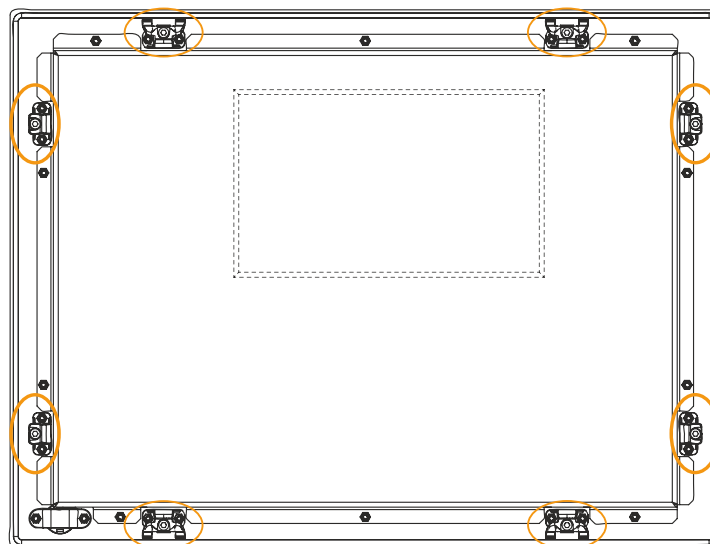

- Secure the clamping blocks by alternately tightening the mounting screws with a 3 mm hex screwdriver (max. tightening torque 0.5 Nm). The mounting screws push the clamping lever downwards, which in turn secures the device to the wall or control cabinet panel.

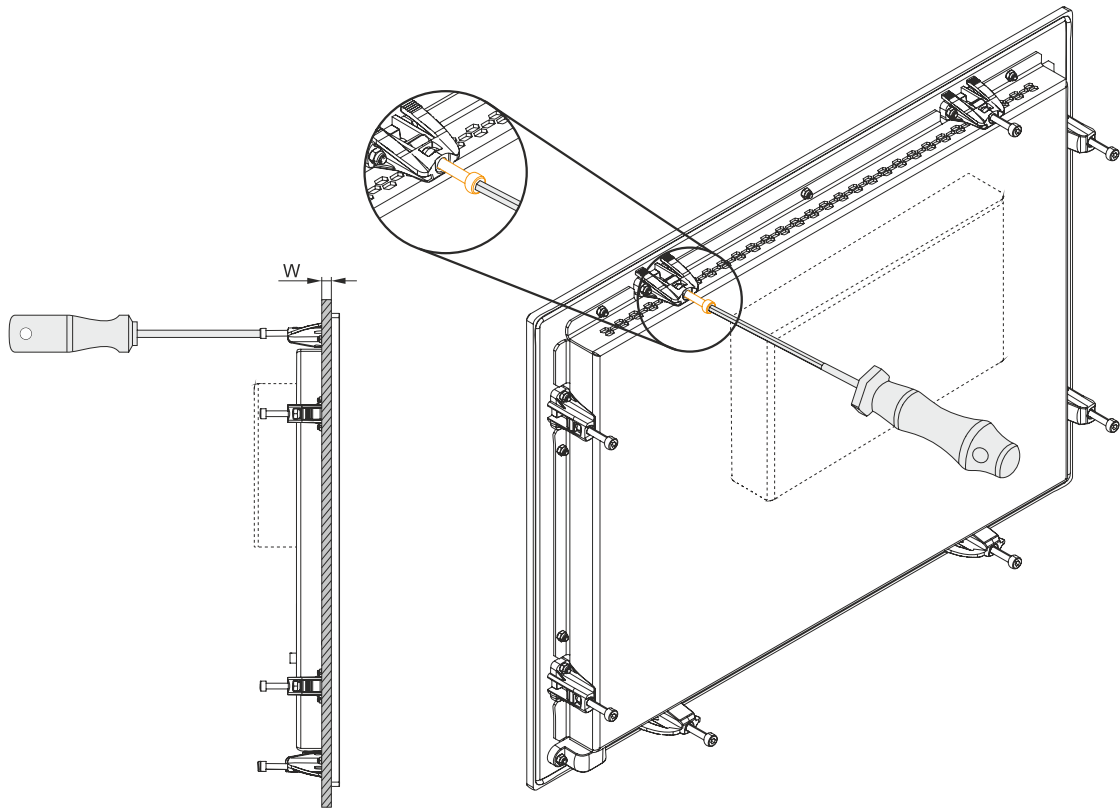

| Thickness of the wall or control cabinet | Minimum                                | Maximum |
|--|--|---------|
| W  | See "Mounting orientations" on page 28 |         |

## 5.1.4 Installation information for individual components

### Information:

If the Panel PC 2100 is not delivered as a complete system but as individual components (or individual components are installed afterward), then these components must be enabled in BIOS. This is done by launching BIOS when booting the system, loading the default BIOS values and then saving the settings. For additional information, see ["Exit" on page 217](#). This is required for the following individual components:

- System unit
- Interface option

### 5.1.5 Replacing the system unit

1. Disconnect the power supply to the Panel PC (disconnect the power cable). Isolate the system from all potential sources of electrical power!
2. Discharge any electrostatic charge on the ground connection.
3. Remove the Panel PC from the control cabinet by following the installation steps in reverse order.
4. Place the Panel PC on a clean, flat surface.
5. Remove the Torx screws (T10) indicated in the following image.

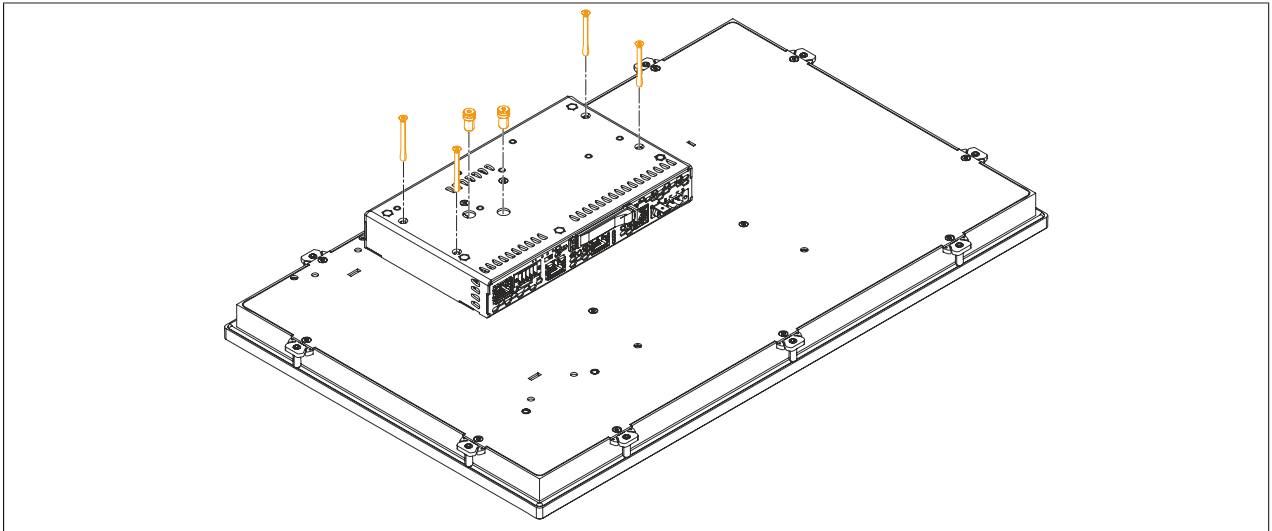

6. The system unit can now be removed by pulling it straight up.

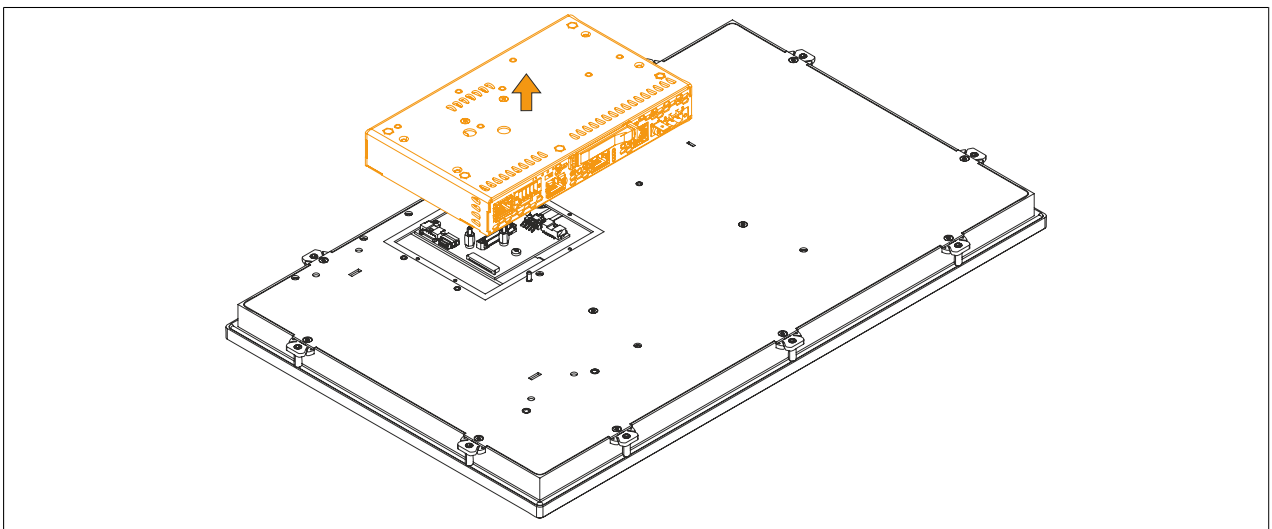

7. The system unit can now be replaced by following these steps in reverse order. The maximum tightening torque of the Torx screws (T10) is 0.5 Nm.  
Only the mounting materials included in delivery are permitted to be used to install the system unit.

### 5.1.6 Installing the USB hub

- USB hub 5ACCUSB4.0000-000 can be used starting with a display diagonal of the panel of at least 10.1".
- The USB hub can be installed starting with the following revisions of the system units:

| System unit       | Minimum revision | System unit       | Minimum revision |
|-------------------|------------------|-------------------|------------------|
| 5PPC2100.BY01-000 | F0               | 5PPC2100.BY11-000 | F0               |
| 5PPC2100.BY22-000 | F0               | 5PPC2100.BY34-000 | F0               |
| 5PPC2100.BY44-000 | G0               | 5PPC2100.BY48-000 | A0               |

1. Install the 4-port USB hub on the side of the system unit using the Torx screws (T10) supplied, tightening torque 0.55 Nm. The mounting direction of the USB hub must be taken into account in order to be able to connect the USB cable to the PPC2100 later.

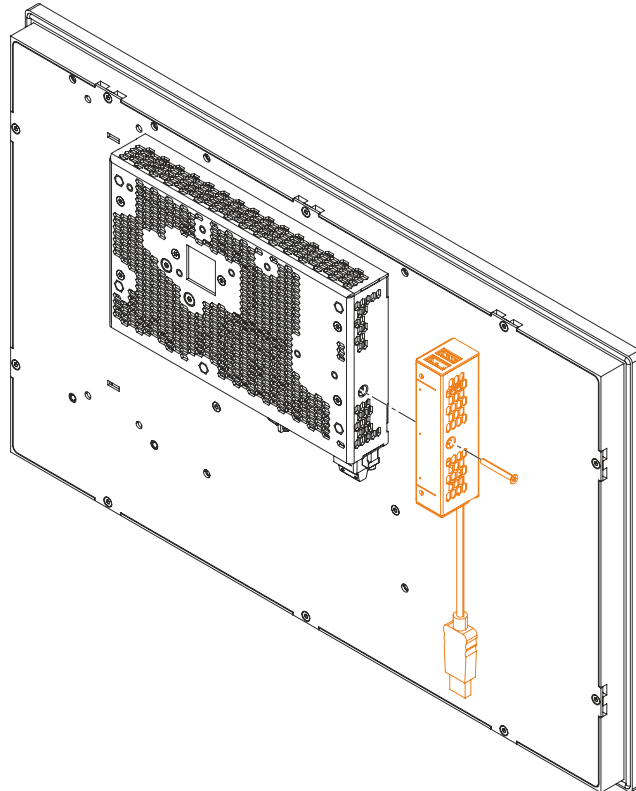

2. Connect the USB cable attached to the USB hub to the USB2 interface of the system unit.

## 5.2 Connecting to the power grid

### Danger!

- The entire power supply must be disconnected and electrostatic discharge must take place on the housing or ground connection before removing any covers or components from the device and installing or removing any accessories, hardware or cables.
- Remove the power cable from the device and from the power supply.
- All covers and components, accessories, hardware and cables must be installed or secured before the device is connected to the power supply and switched on.

### 5.2.1 Installing the DC power cable

### Danger!

The entire power supply to the B&R industrial PC or B&R Automation Panel must be interrupted. Before connecting the DC power cable, it must be checked whether it has been disconnected from the voltage source (e.g. power supply unit).

### 5.2.1.1 Wiring

#### Caution!

The pinout of the power supply interface must be observed!

The DC power cable must be implemented with a wire cross section of 0.75 mm<sup>2</sup> to 1.5 mm<sup>2</sup> and wire end sleeves.

| Conductors of the power cable | Terminal connection symbol  |
|-------------------------------|---|
| +24 VDC                       | +   |
| GND                           |  |
| 0 VDC                         | -   |

#### Installing screw clamp terminal block 0TB103.9

Secure the conductors with wire end sleeves ① in the terminal contacts ③ as shown in the figure below and tighten the screw clamp terminals ④ with a screwdriver (max. tightening torque 0.4 Nm). It is important to pay attention to the label on the screw clamp terminal ②.

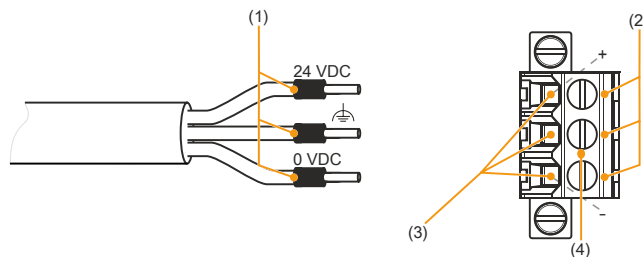

#### Installing cage clamp terminal block 0TB103.91

Insert a screwdriver into the cage clamp terminals ② and secure the conductors with wire end sleeves ① in the terminal contacts ③ as shown in the figure below. Close the terminal contact by removing the screwdriver. It is important to pay attention to the label on the cage clamp terminal ④.

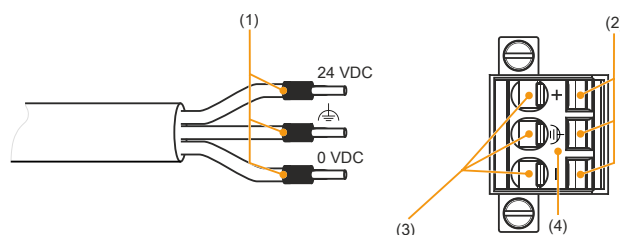

### 5.2.1.2 Connecting the power supply to a B&R device

#### Danger!

The entire power supply to the B&R device must be interrupted. Before connecting the power cable, it must be checked whether it has been disconnected from the voltage source (e.g. power supply unit).

1. Carry out electrostatic discharge on the housing or at the ground connection.
2. Connect the power supply connector to the B&R device and tighten the mounting screws (max. tightening torque 0.5 Nm).

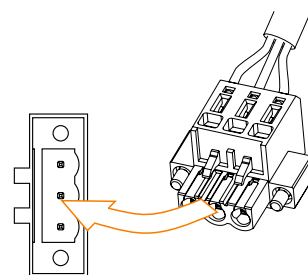

### 5.2.2 Grounding concept - Functional ground

Functional ground is a low impedance current path between circuits and ground. It is used for equipotential bonding and thus for improving immunity to interference.

#### Notice!

Functional grounding does not meet the requirements of protective ground! Suitable measures for electrical safety in the event of operation and faults must be provided separately.

The device is equipped with the following functional ground connections:

- Functional ground connection of the power supply
- Ground connection

The functional ground on the B&R device is marked with the following symbol:



The following points must be observed to ensure that electrical interference is safely diverted:

- Connect the device to the central grounding point (e.g. the control cabinet or the system) using the shortest possible low-resistance path.
- Cable design with at least 2.5 mm<sup>2</sup> per connection. If a cable with wire end sleeve is used with terminal block 0TB103.9 or 0TB103.91, a cable with a maximum of 1.5 mm<sup>2</sup> per connection is possible.
- Observe the shielding concept of the conductors. All data cables connected to the device must be implemented using shielded lines.

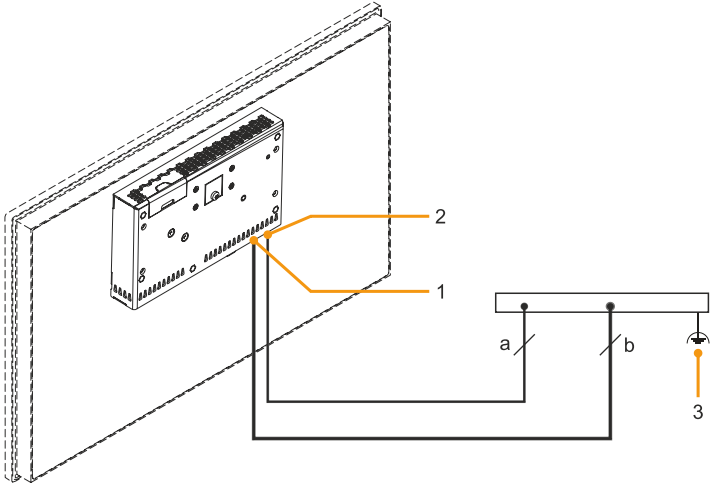

| Legend |   |   |                                       |
|--------|---|---|---------------------------------------|
| 1      | Ground connection  | 2 | Power supply connection +24 VDC pin 2 |
| a      | At least 1.5 mm <sup>2</sup>  | b | At least 2.5 mm <sup>2</sup>          |
|        |   | 3 | Central grounding point               |

| Legend |   |   |                         |
|--------|---|---|-------------------------|
| 1      | Ground connection  | 2 | Central grounding point |
| a      | At least 2.5 mm <sup>2</sup>  |   | -                       |

### 5.3 Connecting cables

When connecting or installing cables, the bend radius specification must be observed. For this specification, see the technical data of the respective cable.

The maximum tightening torque of the locating screws is 0.5 Nm.

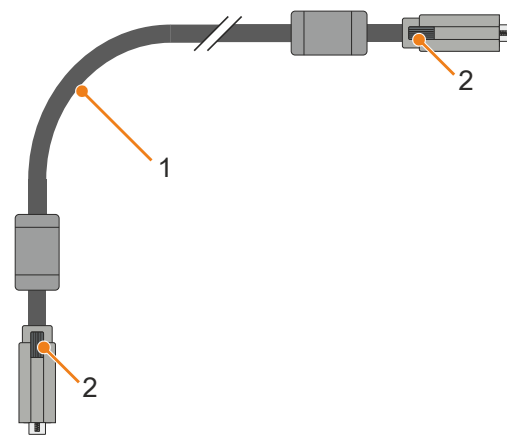

- 1) Bend radius
- 2) Locating screws

# 6 Commissioning

---

## 6.1 Basic information

### Information:

Condensation may form under certain environmental conditions or rapid climatic changes. For improved acclimatization and to avoid damage, the device must be slowly adapted to the room temperature.

## 6.2 Switching on the device for the first time

### 6.2.1 General information before switching on the device

#### Checklist

Before the device is started up for the first time, the following points must be checked:

- Have the installation instructions been observed as described in "[Installation and wiring](#)" on page 169?
- Have the permissible ambient conditions and environmental conditions for the device been taken into account?
- Is the power supply connected correctly and have the values been checked?
- Is the ground cable correctly connected to the ground connection?
- Before installing additional hardware, the device must have been started up.

### Caution!

**Before the device is started up, it must be gradually adapted to room temperature! Exposure to direct heat radiation is not permitted.**

**When transporting at low temperatures or in the event of large temperature fluctuations, the collection of moisture in or on the device is not permitted.**

**Moisture can cause short circuits in electrical circuits and damage the device.**

#### Requirements

The following criteria must be met before switching on the device for the first time:

- The functional ground connections are as short as possible and connected to the central grounding point using the largest possible wire cross section.
- All connection cables are connected correctly.
- A USB keyboard and USB mouse are connected (optional).

### 6.2.2 Switching on the device

#### Procedure

1. Connect the power supply and switch it on (e.g. power supply unit).
2. The device is operating and boots; LED *Power* lights up.



## Information:

To create a separate application, downloads such as the ADI .NET SDK available from the B&R website ([www.br-automation.com](http://www.br-automation.com)).

### 6.3.2.2 Evaluating with the BurnInTest tool from PassMark

If a separate application is not created or used for temperature evaluation, B&R recommends using the BurnInTest software tool from PassMark.

The BurnInTest software tool is available in standard and professional versions. In addition to the software package, various loopback adapters (serial, parallel, USB, etc.) and test CDs or DVDs are also available. Depending on the expansion level of the software and available loopback adapters, a correspondingly high system and peripheral load can be generated.

## Information:

Loopback adapters are also available from PassMark. For additional information, see [www.pass-mark.com](http://www.pass-mark.com).

The following screenshots refer to PassMark BurnInTest Pro V7.1 using a PPC2100 without IF options.

Overview of settings:

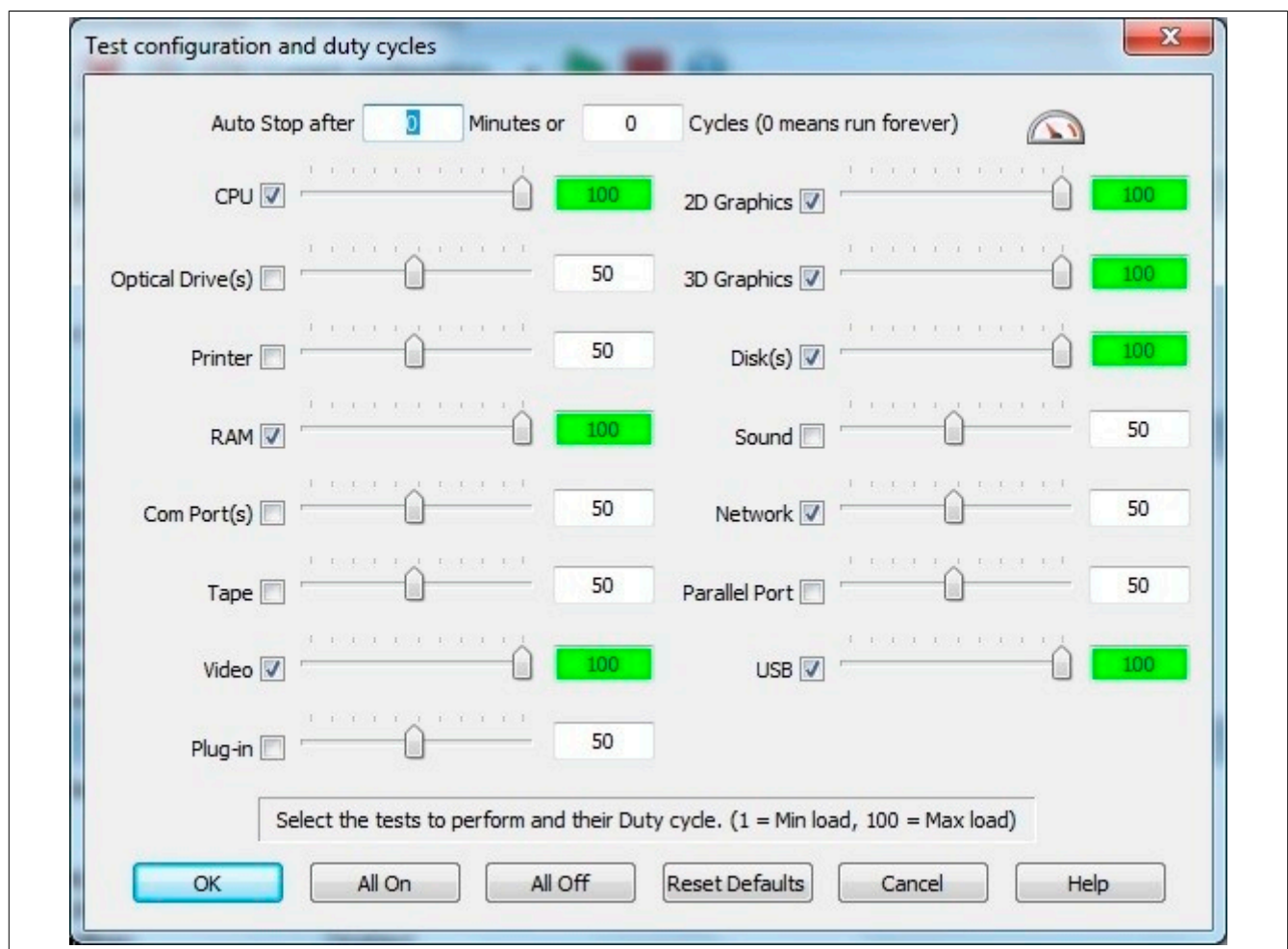

Test overview:

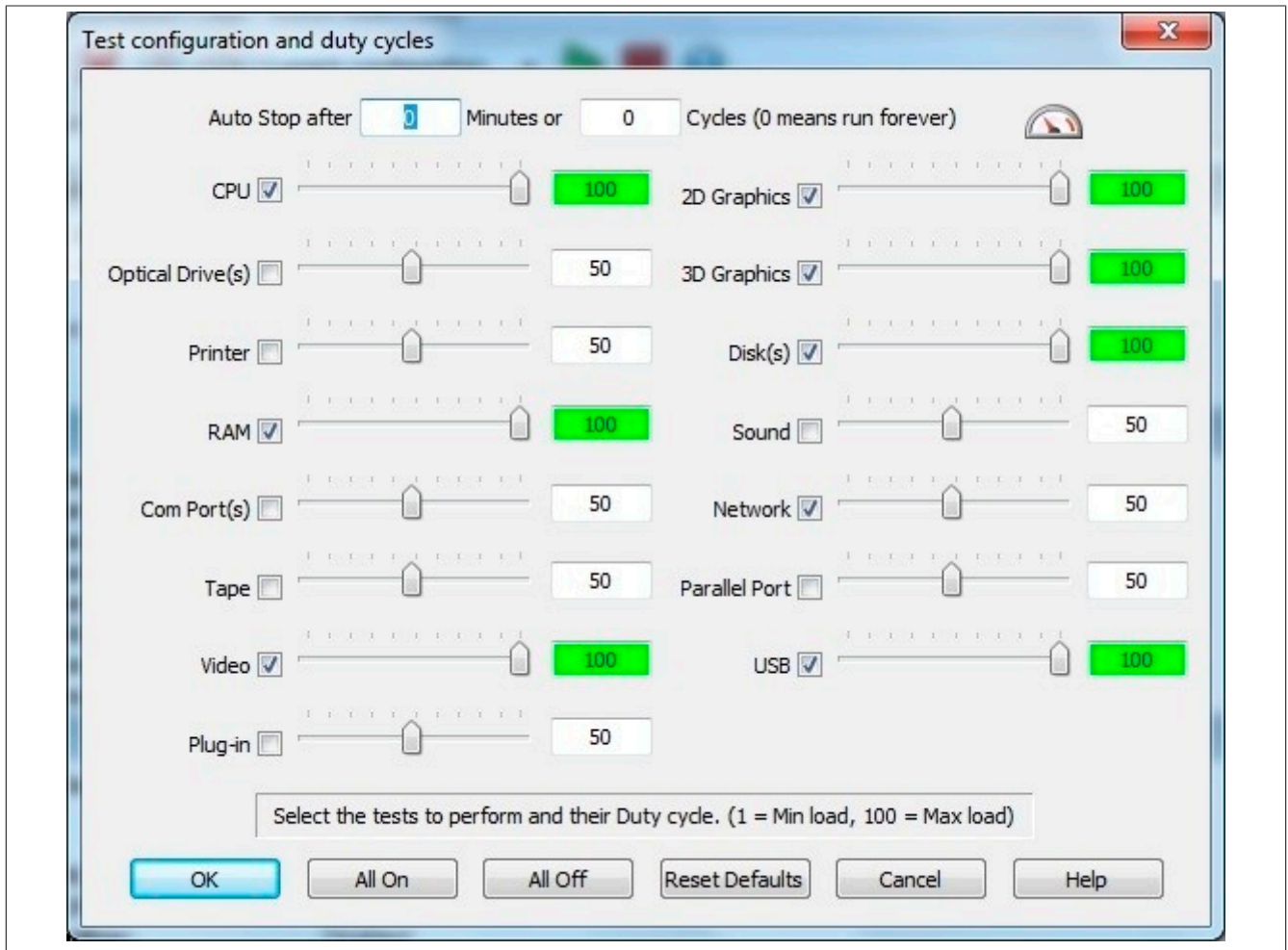

Depending on the availability of the loopback adapters and DVDs, appropriate fine tuning must be carried out in the respective test properties.

If no USB loopback adapters are available, USB flash drives can also be used. These must be available in Windows as formatted drives. Option **USB** must be deselected under **Test selection and duty cycles**, and **Test this device** must then be selected in the **Disk** settings (**Configuration / Test Preferences / Disk**).



Serial loopback adapters can be easily created by connecting some pins as shown.

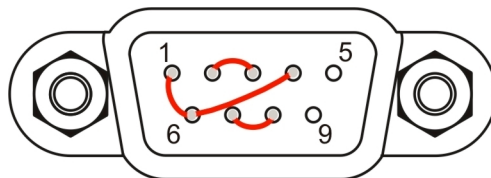

### 6.3.3 Evaluating temperatures in other operating systems

Implementation instructions and sample program are available for evaluating in other operating systems. These can be used to create customized functionality.

Sample programs and implementation instructions can be downloaded at no cost directly from the Downloads section of the B&R website ([www.br-automation.com](http://www.br-automation.com)).

### 6.3.4 Evaluating the measurement results

The recorded maximum temperature value of each individual sensor is not permitted to exceed the temperature limit specified in the user's manuals.

If the temperature tests cannot be carried out in a climate chamber, they can be carried out in an office environment, for example. It is necessary to record the ambient temperature, however. Based on experience gained at B&R, the measured temperature values can be extrapolated linearly to the ambient temperature for passive systems (systems without a fan kit). In order to also be able to extrapolate the temperature values for systems with a fan kit, the fans must be running. The speed, etc. must also be taken into account.

If the temperature tests are carried out in a controlled climate chamber with a fan, the devices to be tested are cooled by this fan and thus the measurement results are distorted. With passive devices, the measurement results are therefore unusable. In order to be able to carry out temperature tests in climate chambers with fans without distorting the measurement results, however, the fan of the climate chamber must be switched off and a correspondingly long lead time (several hours) must be observed.

## 6.4 Touch screen calibration

B&R panels are hardware-calibrated at the factory. This means that recalibration is not usually necessary.

### 6.4.1 Single-touch (analog resistive)

Recalibration is generally not necessary, but B&R recommends recalibration in order to achieve the best results and to adapt the touch screen to the user's needs.

#### 6.4.1.1 Windows 10 IoT Enterprise 2016 LTSB

After starting Windows 10 IoT Enterprise 2016 LTSB on a Panel PC for the first time, the appropriate touch screen driver is installed automatically.

On all other devices, the touch screen driver must be subsequently installed to operate the touch screen. The appropriate driver is available for download in the Downloads section of the B&R website ([www.br-automation.com](http://www.br-automation.com)).

#### 6.4.1.2 Windows 10 IoT Enterprise 2015 LTSB

After starting Windows 10 IoT Enterprise 2015 LTSB on a Panel PC for the first time, the appropriate touch screen driver is installed automatically.

On all other devices, the touch screen driver must be subsequently installed to operate the touch screen. The appropriate driver is available for download in the Downloads section of the B&R website ([www.br-automation.com](http://www.br-automation.com)).

#### 6.4.1.3 Windows Embedded 8.1 Industry Pro

After starting Windows Embedded 8.1 Industry Pro on the Panel PC for the first time, the corresponding touch screen driver is installed automatically.

On all other devices, the touch screen driver must be subsequently installed to operate the touch screen. The appropriate driver is available for download in the Downloads section of the B&R website ([www.br-automation.com](http://www.br-automation.com)).

#### 6.4.1.4 Windows 7 Professional / Ultimate

After installing Windows 7 on the device, the touch screen driver must be installed in order to operate the touch screen. The appropriate driver is available for download in the Downloads section of the B&R website ([www.br-automation.com](http://www.br-automation.com)).

#### 6.4.1.5 Windows Embedded Standard 7 Embedded / Premium

A touch screen driver will be installed automatically if a touch controller is detected during the Windows Embedded Standard 7 installation.

The touch screen driver must be installed manually if a touch screen controller was not detected when installing Windows Embedded Standard 7 or if an Automation Panel has been connected after installation. The appropriate driver is available for download in the Downloads section of the B&R website ([www.br-automation.com](http://www.br-automation.com)).

## 6.4.2 Multi-touch (projected capacitive - PCT)

### 6.4.2.1 Windows 10 IoT Enterprise 2016 LTSB

Microsoft multi-touch drivers are installed on the device during installation of Windows 10 IoT Enterprise 2016 LTSB. After successful installation, the device is immediately ready for operation.

### 6.4.2.2 Windows 10 IoT Enterprise 2015 LTSB

Microsoft multi-touch drivers are installed on the device during installation of Windows 10 IoT Enterprise 2015 LTSB. After successful installation, the device is immediately ready for operation.

### 6.4.2.3 Windows Embedded 8.1 Industry Pro

Microsoft multi-touch drivers are installed on the device during installation of Windows Embedded 8.1 Industry Pro. After successful installation, the device is immediately ready for operation.

### 6.4.2.4 Windows 7 Professional / Ultimate

Microsoft multi-touch drivers are installed on the device during installation of Windows 7. After successful installation, the device is immediately ready for operation.

### 6.4.2.5 Windows Embedded Standard 7 Premium

Microsoft multi-touch drivers are installed on the device during installation of Windows Embedded Standard 7 Premium. After successful installation, the device is immediately ready for operation.

## 6.5 Display brightness control

1. Open the ADI Control Center in the Control Panel.
2. Select tab "Display".
3. Select a panel from the list. Only the local display (PP Link) and connected panels are displayed in the list.
4. Set the desired brightness using the slider (the figure is symbolic).

### Information:

The changed settings are displayed online but only applied by the system (and used after the next restart) if the ADI Control Center is exited with **OK**.

The configured brightness is independent of the value configured in BIOS Setup, i.e. the value set in BIOS is used until Windows boots. The value set in BIOS is only applied the first time the ADI Control Center is launched.

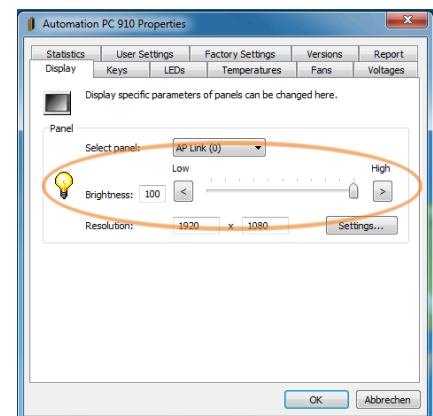

## 6.6 Known problems / Characteristics

- CAN IF option 5ACCIF01.ICAN-000 is supported in Windows 7 and later by PVI V4.2.5 or Windows CAN driver V3.0.
- If problems occur with the ETH1 or ETH2 interface (connection abort, slow data transfer, etc.), the Energy-Efficient Ethernet feature can be disabled in the driver as a possible solution.
- If USB 3.0 should be used, XHCI mode must be set in the "USB configuration" for the following operating systems:
  - Windows 10 or Windows 8.1 to "Enabled"
  - Windows 7 to "Smart auto"

If XHCI mode is set to "Smart auto" in Windows 8.1 or Windows 10, then only USB 2.0 is supported. The default value for setting "XHCI mode" is "Smart auto".

- If problems occur during shutdown or rebooting in Linux for B&R, the USB 3.0 function can be disabled as a possible workaround. To do this, the XHCI controller must be set to "Disabled" in the BIOS USB configuration.
- To slightly improve the real-time behavior (jitter) of the Automation Runtime Windows (ARwin) or Automation Runtime Embedded (AREmb) with a graphics-intensive application, the BIOS setting *Advanced - Graphics (IGD) Configuration - IGD Turbo* can be set to *Disabled*. If the BIOS setting *Advanced - Graphics (IGD) Configuration - IGD Turbo* is set to *Disabled*, the graphics performance of the system is noticeably reduced.
- MTCX version 1.25 or higher must be used starting with the following revisions. New devices are delivered with the corresponding MTCX version.

| Order number      | Rev. | Order number      | Rev. | Order number      | Rev. |
|-------------------|------|-------------------|------|-------------------|------|
| 5PPC2100.BY01-000 | N0   | 5PPC2100.BY22-000 | N0   | 5PPC2100.BY44-000 | N0   |
| 5PPC2100.BY11-000 | M0   | 5PPC2100.BY34-000 | N0   | 5PPC2100.BY48-000 | J0   |

If an MTCX version less than 1.25 is used on a device with the previously mentioned revisions, the system unit does not provide correct temperature values from [system unit sensors 1 and 2](#).

Projects in Automation Studio must be updated with the following HWX upgrades or higher:

| Order number      | HWX      | Order number      | HWX      | Order number      | HWX      |
|-------------------|----------|-------------------|----------|-------------------|----------|
| 5PPC2100.BY01-000 | V1.4.2.0 | 5PPC2100.BY22-000 | V2.1.2.0 | 5PPC2100.BY44-000 | V2.1.2.0 |
| 5PPC2100.BY11-000 | V1.4.2.0 | 5PPC2100.BY34-000 | V2.1.2.0 | 5PPC2100.BY48-000 | V2.1.2.0 |

## 7 Software

### 7.1 BIOS options

#### Information:

The following figures, BIOS menu options and descriptions refer to BIOS version 1.44. It is therefore possible that these diagrams and BIOS descriptions will not correspond with the BIOS version actually installed. In addition, the BIOS menu options provided depend on the system configuration.

#### 7.1.1 General information

BIOS is the abbreviation for "Basic Input and Output System". It is the basic standardized connection between user and system (hardware). This B&R industrial PC uses BIOS from Phoenix.

The BIOS Setup Utility allows you to modify basic system configuration settings. These settings are stored in the CMOS and EEPROM (as backup).

CMOS data is nonvolatile and remains stored on the B&R industrial PC for a certain amount of time even when the power is switched off (no 24 VDC power supply). For more information, see the technical data of the system unit.

#### Information:

The following BIOS settings are system-optimized. Changes should only be made by experts who have knowledge of their effects.

#### 7.1.2 BIOS Setup and start procedure

BIOS is enabled immediately after switching on the power supply of the B&R industrial PC or pressing the power button. A check takes place as to whether the setup data from the EEPROM is "OK". If "OK", the data is transferred to the CMOS. If "not OK", the CMOS data is checked for validity. If the CMOS data is also invalid, an error message is output and the boot procedure can be resumed without problems by pressing the <F1> key. To prevent an error message from appearing on each restart, launch the BIOS Setup utility by pressing <F2> and resave the settings.

BIOS reads the system configuration information, checks the system and configures it through the power-on self-test (POST).

When these "preparations" are completed, BIOS searches the system for an operating system in the available data storage devices (hard disk drive, floppy disk drive, etc.). BIOS starts the operating system and transfers to it control over system operations.

To enter BIOS Setup, the "F2" key must be pressed after the USB controller has been initialized as soon as the following message appears on the monitor (during POST): "F2 = Setup"

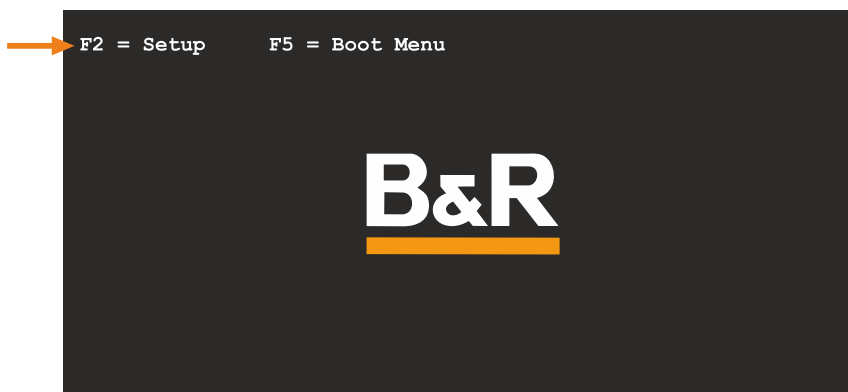

#### 7.1.3 BIOS default settings

Setting options marked in bold represent the default value.

If function "Load setup defaults" is selected in the BIOS Setup main menu, or if "Exit" is selected (or F9 is pressed) in the individual setup screens, the default values are the optimized values that will be used.

### 7.1.4 BIOS Setup buttons

The following keys are enabled during POST:

#### Information:

The key signals of the USB keyboard are only accepted after initializing the USB controller.

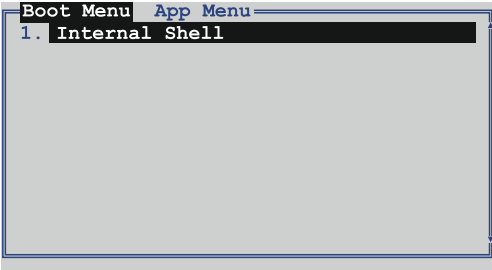
| Keys    | Function   |
|---------|--|
| F2      | Access to the BIOS Setup menu.   |
| F5      | Opens the boot menu. This lists all bootable devices that are connected to the system. Selecting a device with cursor ↑, cursor ↓ and then pressing <ENTER> will boot from that device.<br> |
| <Pause> | The POST can be stopped with the <Pause> button. After pressing any other key, the POST continues to run.  |

The following keys can be used after entering BIOS Setup:

| Key      | Function  |
|----------|---|
| F1       | General help.   |
| Cursor ↑ | Go to previous object.                                    |
| Cursor ↓ | Go to next object.  |
| Cursor ← | Go to previous object.                                    |
| Cursor → | Go to next object.  |
| + -      | Changes the setting of the selected function.             |
| Enter    | Switches to the selected menu.                            |
| Page ↑   | Jumps to the first BIOS menu option or object.            |
| Page ↓   | Jumps to the last BIOS menu option or object.             |
| Home     | Jumps to the first BIOS menu option or object.            |
| End      | Jumps to the last BIOS menu option or object.             |
| F7       | Resets the changes.                                       |
| F9       | Loads and sets CMOS default values for all BIOS settings. |
| F10      | Saves and closes.   |
| Esc      | Exits the submenu.  |

## 7.1.5 Main

The BIOS Setup main menu appears immediately after the F2 button is pressed during system startup.

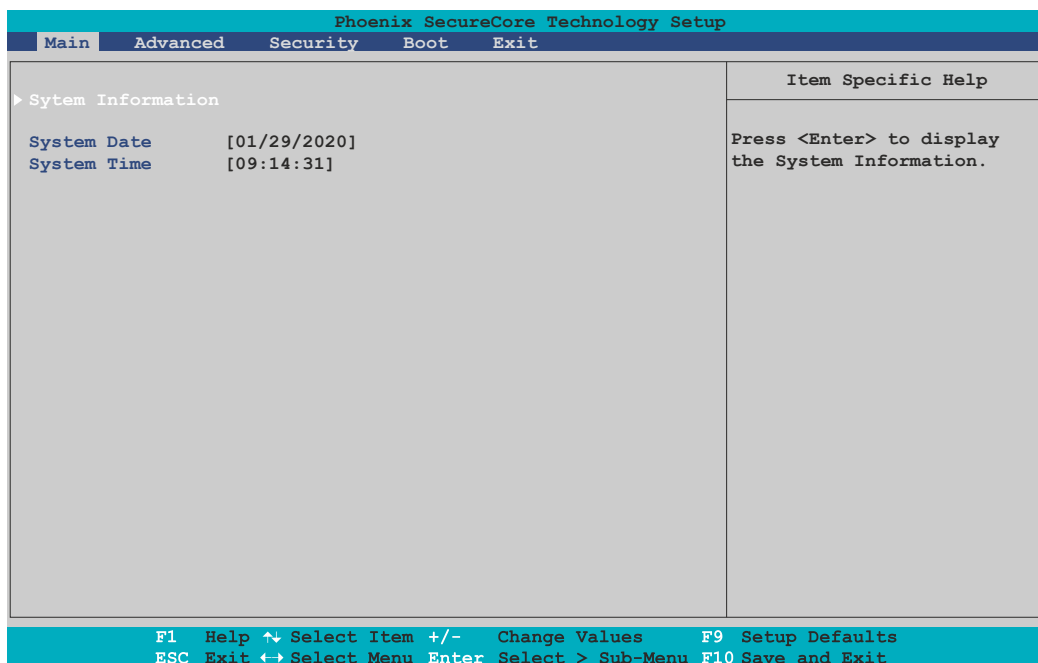

| BIOS setting       | Explanation  | Configuration options  | Effect  |
|--------------------|--|------------------------|---|
| System information | Displays information about the chipset, CPU board and main memory.   | Enter                  | Opens this submenu<br>See " <a href="#">System information</a> " on page 192. |
| System date        | The currently configured system date. Buffered after the system is switched off. For details, see technical data of the system unit.         | Change the system date | Sets the system date in the format Month:Day:Year (mm:dd:yyyy).               |
| System time        | The currently configured system time setting. Buffered after the system is switched off. For details, see technical data of the system unit. | Change the system time | Sets the system time in the format Hour:Minute:Second (hh:mm:ss).             |

### 7.1.5.1 System information

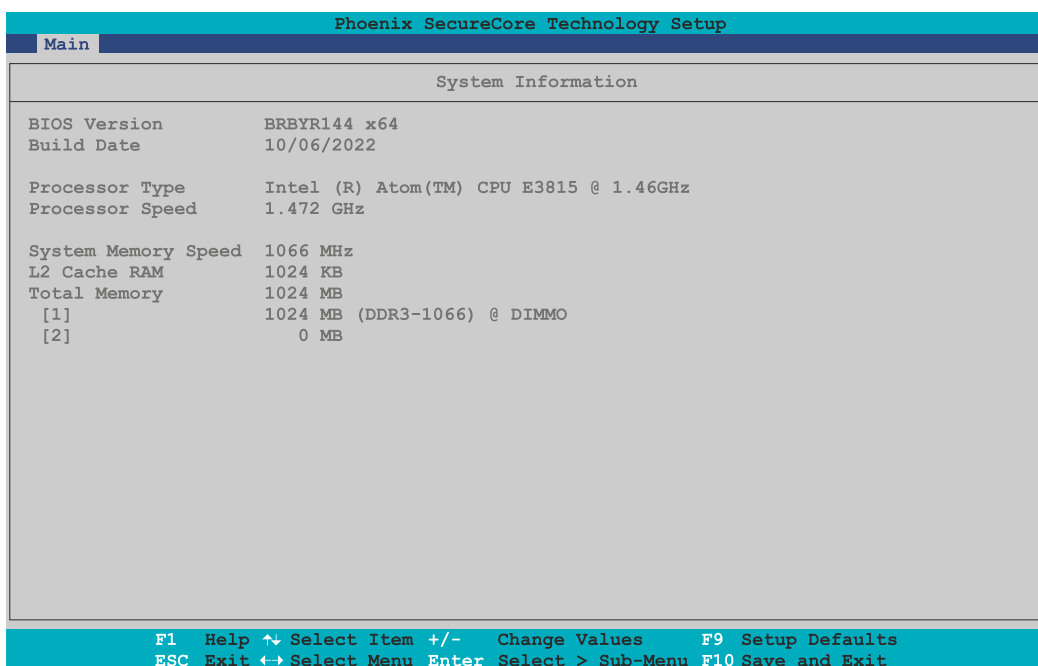

| BIOS setting        | Explanation                             | Configuration options | Effect |
|---------------------|---|-----------------------|--------|
| BIOS version        | Displays the BIOS version.              | None                  | -      |
| Build time          | Displays the date the BIOS was created. | None                  | -      |
| Processor type      | Displays the processor type.            | None                  | -      |
| Processor speed     | Displays the processor frequency.       | None                  | -      |
| System memory speed | Displays the main memory frequency.     | None                  | -      |

| BIOS setting | Explanation                              | Configuration options | Effect |
|--------------|--|-----------------------|--------|
| L2 cache RAM | Displays the L2 cache size.              | None                  | -      |
| Total memory | Displays the total main memory size.     | None                  | -      |
| [1]          | Displays the main memory size in slot 1. | None                  | -      |
| [2]          | Displays the main memory size in slot 2. | None                  | -      |

## 7.1.6 Advanced

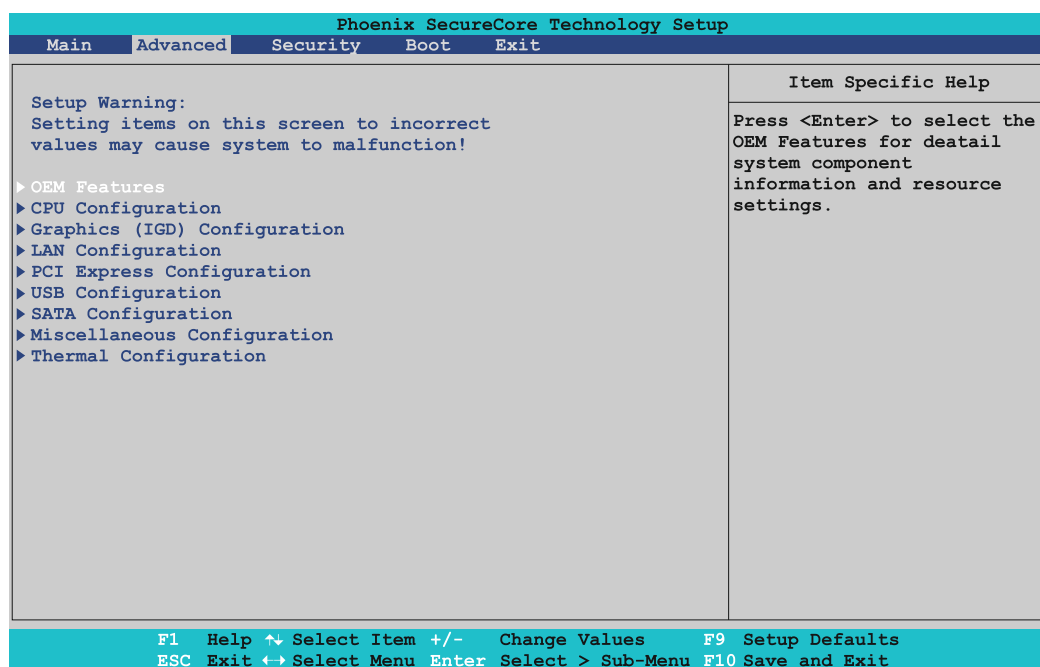

| BIOS setting                        | Explanation                          | Configuration options | Effect  |
|-------------------------------------|--------------------------------------|-----------------------|---|
| <b>OEM features</b>                 | Configures OEM features.             | Enter                 | Opens this submenu<br>See "OEM features" on page 195.                 |
| <b>CPU configuration</b>            | Configures CPU settings.             | Enter                 | Opens this submenu<br>See "CPU configuration" on page 202.            |
| <b>Graphics (IGD) configuration</b> | Configures the graphic settings.     | Enter                 | Opens this submenu<br>See "Graphics (IGD) configuration" on page 204. |
| <b>LAN configuration</b>            | Configures LAN settings.             | Enter                 | Opens this submenu<br>See "LAN" on page 206.                          |
| <b>PCI Express configuration</b>    | Configures PCI Express settings.     | Enter                 | Opens this submenu<br>See "PCI express configuration" on page 207.    |
| <b>USB configuration</b>            | Configures USB settings.             | Enter                 | Opens this submenu<br>See "USB configuration" on page 209.            |
| <b>SATA configuration</b>           | Configures SATA settings.            | Enter                 | Opens this submenu<br>See "SATA configuration" on page 210.           |
| <b>Miscellaneous configuration</b>  | Configures various settings.         | Enter                 | Opens this submenu<br>See "Miscellaneous configuration" on page 210.  |
| <b>Thermal configuration</b>        | Configures the temperature settings. | Enter                 | Opens this submenu<br>See "Thermal configuration" on page 211.        |

## 7.1.6.1 OEM features

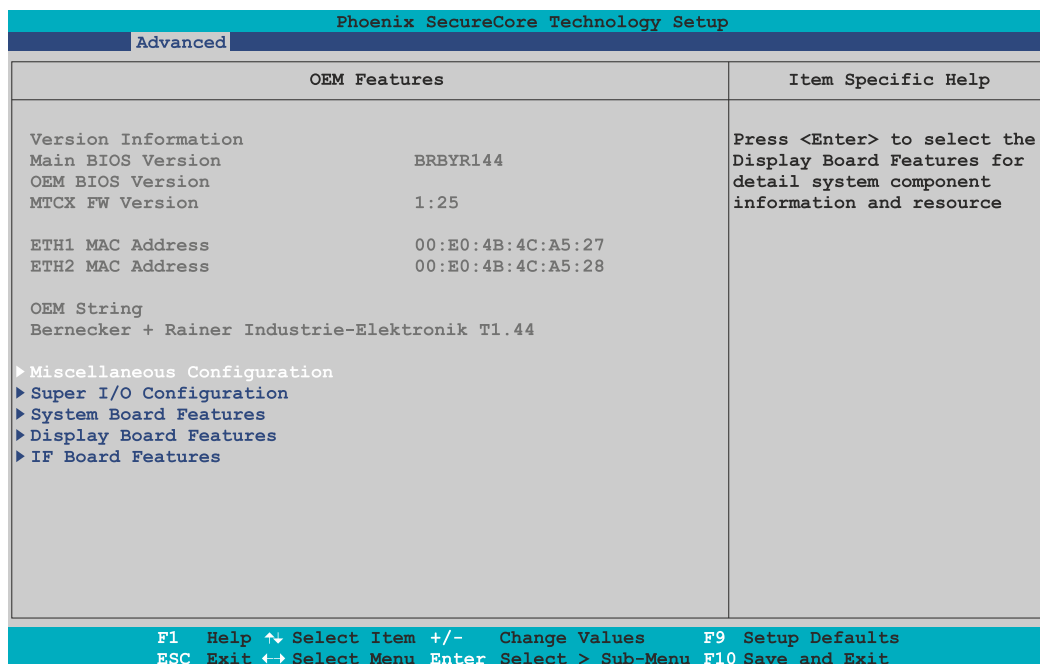

| BIOS setting                       | Explanation   | Configuration options | Effect   |
|------------------------------------|---|-----------------------|--|
| Version information                |   | None                  | -  |
| Main BIOS version                  | Displays the installed B&R BIOS version.                  | None                  | -  |
| OEM BIOS version                   |   | None                  | -  |
| MTCX firmware version              | Displays the installed MTCX version.                      | None                  | -  |
| ETH1 MAC address                   | Displays the assigned MAC address for the ETH1 interface. | None                  | -  |
| ETH2 MAC address                   | Displays the assigned MAC address for the ETH2 interface. | None                  | -  |
| OEM string                         | Displays the OEM string.                                  | None                  | -  |
| <b>Miscellaneous configuration</b> | Configures various settings.                              | Enter                 | Opens this submenu<br>See "Miscellaneous configuration" on page 196. |
| <b>Super I/O configuration</b>     | Configures special settings for the interfaces.           | Enter                 | Opens this submenu<br>See "Super I/O configuration" on page 196.     |
| <b>System board features</b>       | Displays device-specific information for the system unit. | Enter                 | Opens this submenu<br>See "System board features" on page 197.       |
| <b>Display board features</b>      | Displays device-specific information for the display.     | Enter                 | Opens this submenu<br>See "Display board features" on page 199.      |
| <b>IF board features</b>           | Displays device-specific information for the IF option.   | Enter                 | Opens this submenu<br>See "IF board features" on page 201.           |

### 7.1.6.1.1 Miscellaneous configuration

**Phoenix SecureCore Technology Setup**

Advanced

| Miscellaneous Configuration  | Item Specific Help   |
|--|--|
| After Power loss <b>[Power On]</b><br>Test Interface <b>[Disabled]</b> | Affects the following settings:<br><br>DTS disabled<br>P-States/C-States disabled<br>Turbo Boost disabled<br>RP 1 ASPM disabled.<br><br>The respective setup items will be ignored |

F1 Help    ↕ Select Item    +/- Change Values    F9 Setup Defaults  
 ESC Exit    ↔ Select Menu    Enter Select > Sub-Menu    F10 Save and Exit

| BIOS setting     | Explanation   | Configuration options | Effect   |
|------------------|---|-----------------------|--|
| After power loss | Option for setting the behavior after a power loss. | Stay off              | The PC remains switched off during a power on. |
|                  |   | <b>Power on</b>       | The PC is restarted during a power on.         |
| Test interface   |   | None                  | -  |

### 7.1.6.1.2 Super I/O configuration

**Phoenix SecureCore Technology Setup**

Advanced

| Super I/O Configuration  | Item Specific Help  |
|--|---|
| Serial Port A <b>[Default]</b><br>Base Address    [ 3F8]<br>IRQ                [4] | Enable/Disable Serial Port.<br>Disabled: Disable Port.<br>Manual: Set Port values manual<br>Default: Use system default values. |
| Serial Port B    [Default]<br>Base Address    [ 2F8]<br>IRQ                [3]     |   |
| CAN                [Default]<br>Base Address    [ 384]<br>IRQ                [10]  |   |

F1 Help    ↕ Select Item    +/- Change Values    F9 Setup Defaults  
 ESC Exit    ↔ Select Menu    Enter Select > Sub-Menu    F10 Save and Exit

| BIOS setting  | Explanation                                     | Configuration options             | Effect   |
|---------------|---|-----------------------------------|--|
| Serial port A | Setting for the COM interface of the IF option. | Disabled                          | Disables the interface.                                    |
|               |   | Manual                            | Manual settings for "Base address" and "IRQ" are possible. |
|               |   | <b>Default</b>                    | Default settings are used.                                 |
| Base address  | Sets or displays the I/O address.               | <b>3F8h</b>                       | Default setting  |
|               |   | Any                               | Any I/O address can be entered.                            |
| IRQ           | Sets or displays the IRQ.                       | 3, 4, 5, 6, 7, 10, 11, 12, 14, 15 | Manual assignment.   |
| Serial port B | Setting for the onboard touch screen.           | Disabled                          | Disables the interface.                                    |
|               |   | Manual                            | Manual settings for "Base address" and "IRQ" are possible. |
|               |   | <b>Default</b>                    | Default settings are used.                                 |
| Base address  | Sets or displays the I/O address.               | <b>2F8h</b>                       | Default setting  |
|               |   | Any                               | Any I/O address can be entered.                            |

| BIOS setting | Explanation                                     | Configuration options             | Effect  |
|--------------|---|-----------------------------------|---|
| IRQ          | Sets or displays the IRQ.                       | 3, 4, 5, 6, 7, 10, 11, 12, 14, 15 | Manual assignment.  |
| CAN          | Setting for the CAN interface of the IF option. | Default                           | Default settings are used. Further settings are not possible. |
| Base address | Displays the I/O address.                       | 384h/385h                         | Fixed assignment. This setting cannot be changed.             |
| IRQ          | Displays IRQ.                                   | 10                                | Fixed assignment. This setting cannot be changed.             |

### 7.1.6.1.3 System board features

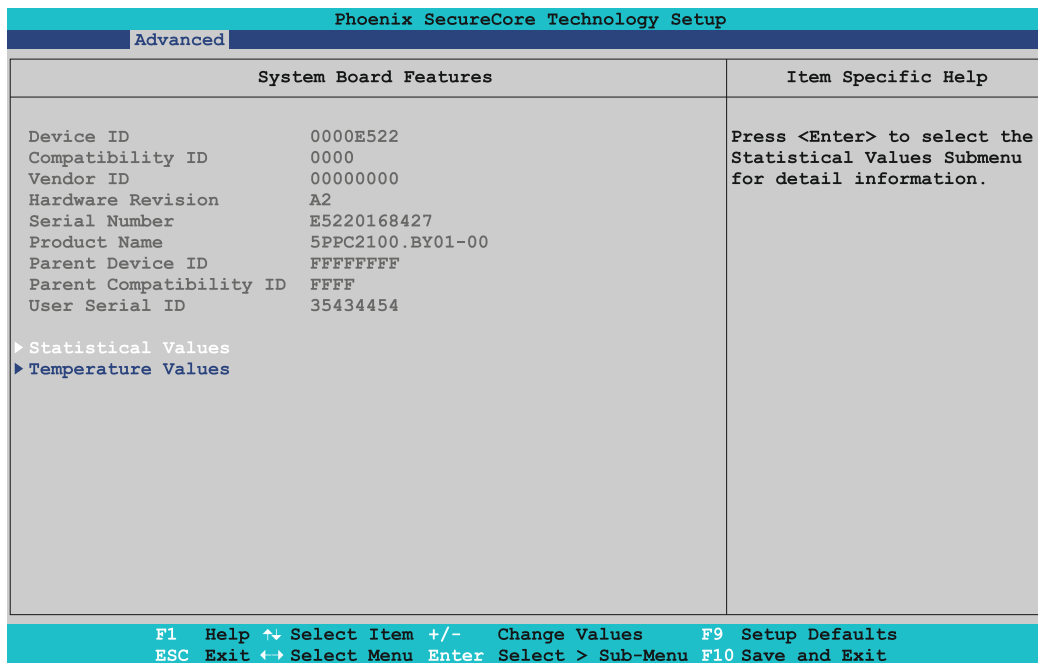

| BIOS setting            | Explanation  | Configuration options | Effect  |
|-------------------------|--|-----------------------|---|
| Device ID               | Displays the device ID of the system unit.   | None                  | -   |
| Compatibility ID        | Displays the version of the device within the same B&R device ID. This ID is required for Automation Runtime.  | None                  | -   |
| Vendor ID               | Displays the manufacturer ID.  | None                  | -   |
| Hardware revision       | Displays the hardware revision of the system unit.   | None                  | -   |
| Serial number           | Displays the B&R serial number.  | None                  | -   |
| Product name            | Displays the B&R model number.   | None                  | -   |
| Parent device ID        | Displays the manufacturer number.  | None                  | -   |
| Parent Compatibility ID | Displays the manufacturer ID.  | None                  | -   |
| User serial ID          | Displays the user serial ID. This 8-digit hex value is freely available to the user (e.g. to allow the device to be uniquely identified) and can only be changed with the B&R Control Center provided by B&R via the ADI driver. | None                  | -   |
| Statistical values      | Displays the statistical values.   | Enter                 | Opens this submenu<br>See "Statistical values" on page 198. |
| Temperature Values      | Displays current temperature values.   | Enter                 | Opens this submenu<br>See "Temperature values" on page 198. |

## 7.1.6.1.3.1 Statistical values

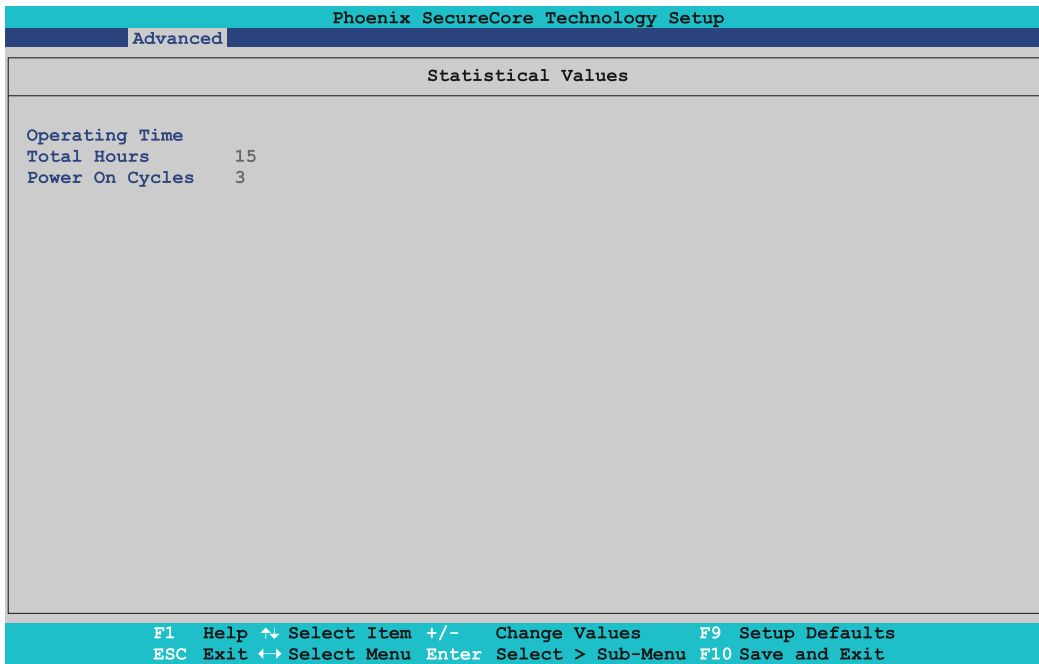

| BIOS setting    | Explanation   | Configuration options | Effect |
|-----------------|---|-----------------------|--------|
| Total hours     | Displays the runtime in hours.  | None                  | -      |
| Power on cycles | Displays the power on cycles - Each restart increases the counter by one. | None                  | -      |

## 7.1.6.1.3.2 Temperature values

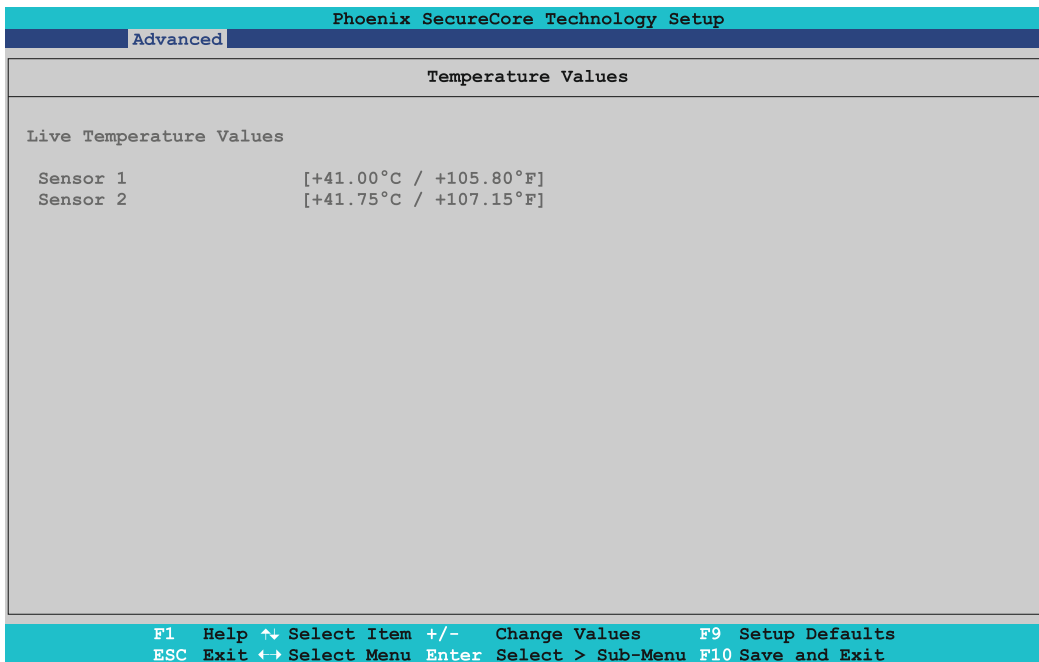

| BIOS setting | Explanation   | Configuration options | Effect |
|--------------|---|-----------------------|--------|
| Sensor 1     | Displays the current temperature of sensor 1 (system unit sensor 2) in °C and °F (sensor close to the RAM). | None                  | -      |
| Sensor 2     | Displays the current temperature of sensor 2 (system unit sensor 1) in °C and °F (sensor near the CPU).     | None                  | -      |

### 7.1.6.1.4 Display board features

**Phoenix SecureCore Technology Setup**

Advanced

| Display Board Features   | Item Specific Help   |
|--|--|
| Device ID                    0000E1B0<br>Compatibility ID            0000<br>Vendor ID                    00000000<br>Hardware Revision         A0<br>Serial Number                E1B00168649<br>Product Name                5AP923.1215-00<br>Parent Device ID            FFFFFFFF<br>Parent Compatibility ID    FFFF<br><br>▶ Statistical Values<br>▶ Temperature Values<br><br>▶ Panel #15 | Press <Enter> to select the Statistical Values Submenu for detail information. |

F1 Help ↕ Select Item +/- Change Values      F9 Setup Defaults  
 ESC Exit ↔ Select Menu Enter Select > Sub-Menu F10 Save and Exit

| BIOS setting              | Explanation   | Configuration options | Effect  |
|---------------------------|---|-----------------------|---|
| Device ID                 | Displays the device ID of the panel.  | None                  | -   |
| Compatibility ID          | Displays the version of the device within the same B&R device ID. This ID is required for Automation Runtime. | None                  | -   |
| Vendor ID                 | Displays the manufacturer ID.   | None                  | -   |
| Hardware revision         | Displays the hardware revision of the panel.  | None                  | -   |
| Serial number             | Displays the B&R serial number.   | None                  | -   |
| Product name              | Displays the B&R model number.  | None                  | -   |
| Parent device ID          | Displays the manufacturer number.   | None                  | -   |
| Parent Compatibility ID   | Displays the manufacturer ID.   | None                  | -   |
| <b>Statistical values</b> | Displays the statistical values.  | Enter                 | Opens this submenu<br>See "Statistical values" on page 199. |
| <b>Temperature Values</b> | Displays current temperature values.  | Enter                 | Opens this submenu<br>See "Temperature values" on page 200. |
| <b>Panel #15</b>          | Displays the panel properties of the panel.   | Enter                 | Opens this submenu<br>See "Panel #15" on page 200.          |

#### 7.1.6.1.4.1 Statistical values

**Phoenix SecureCore Technology Setup**

Advanced

| Statistical Values  |
|---|
| Operating Time<br>Total Hours                15<br>Power On Cycles            3 |

F1 Help ↕ Select Item +/- Change Values      F9 Setup Defaults  
 ESC Exit ↔ Select Menu Enter Select > Sub-Menu F10 Save and Exit

| BIOS setting    | Explanation   | Configuration options | Effect |
|-----------------|---|-----------------------|--------|
| Total hours     | Displays the runtime in hours.  | None                  | -      |
| Power on cycles | Displays the power on cycles - Each restart increases the counter by one. | None                  | -      |

### 7.1.6.1.4.2 Temperature values

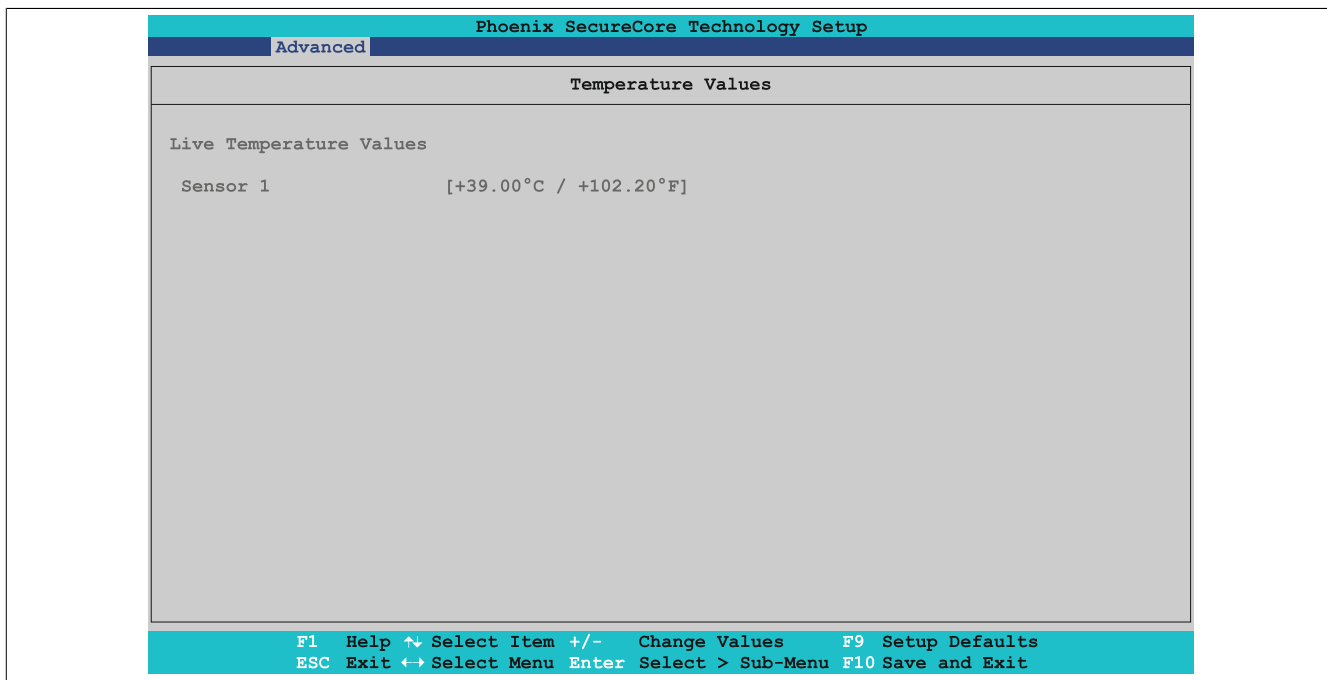

| BIOS setting | Explanation   | Configuration options | Effect |
|--------------|---|-----------------------|--------|
| Sensor 1     | Displays the current temperature of sensor 1 (display or panel) in °C and °F. | None                  | -      |

Table 83: Advanced - OEM features - Display board features - Temperature values

### 7.1.6.1.4.3 Panel #15

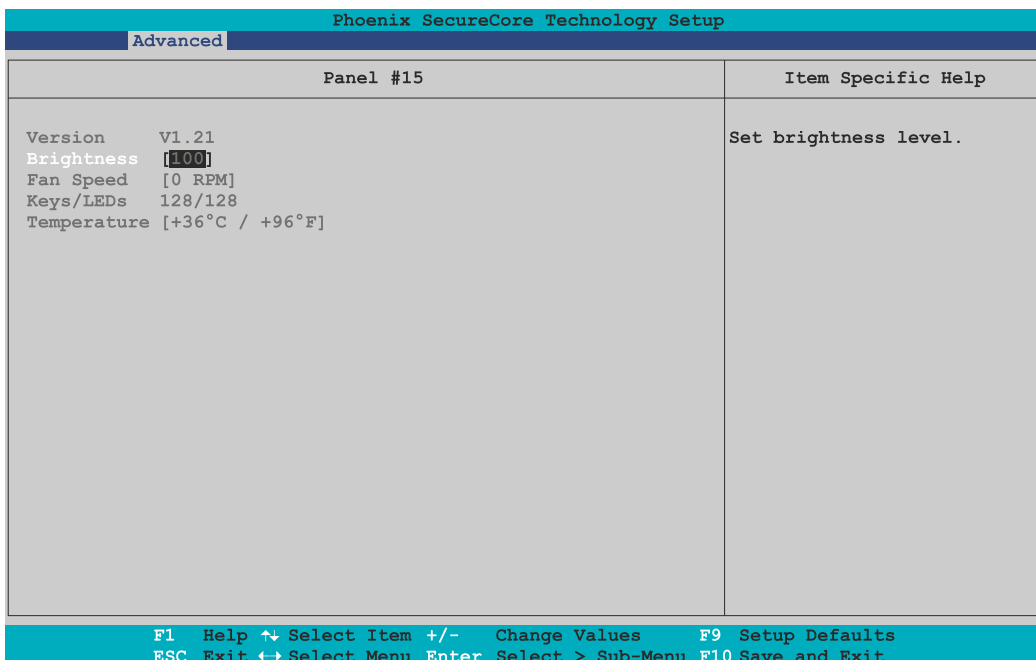

| BIOS setting | Explanation   | Configuration options | Effect  |
|--------------|---|-----------------------|---|
| Version      | Displays the panel firmware version.                | None                  | -   |
| Brightness   | Sets the display brightness.                        | 0 to 100              | Sets the brightness of the selected panel in %. Settings take effect immediately. |
| Fan speed    | Displays the fan speed of the panel.                | None                  | -   |
| Keys/LEDs    | Displays the available keys and LEDs for the panel. | None                  | -   |
| Temperature  | Displays the temperature of the panel in °C and °F. | None                  | -   |

## 7.1.6.1.5 IF board features

| Phoenix SecureCore Technology Setup   |  |  |
|---|--|--|
| Advanced  |  |  |
| IF Board Features   | Item Specific Help   |  |
| Device ID                    0000E53F<br>Compatibility ID            0000<br>Vendor ID                    00000000<br>Hardware Revision          A0<br>Serial Number                E53F0168528<br>Product Name                5ACCIF01.FPSC-000<br>Parent Device ID            FFFFFFFF<br>Parent Compatibility ID    FFFF<br><br>▶ Statistical Values | Press <Enter> to select the Statistical Values Submenu for detail information. |  |
| F1 Help   ↕ Select Item +/-    Change Values            F9 Setup Defaults<br>ESC Exit   ↔ Select Menu    Enter Select > Sub-Menu   F10 Save and Exit  |  |  |

| BIOS setting              | Explanation   | Configuration options | Effect  |
|---------------------------|---|-----------------------|---|
| Device ID                 | Displays the device ID of IF option.  | None                  | -   |
| Compatibility ID          | Displays the version of the device within the same B&R device ID. This ID is required for Automation Runtime. | None                  | -   |
| Vendor ID                 | Displays the manufacturer ID.   | None                  | -   |
| Hardware revision         | Displays the hardware revision of the IF option.  | None                  | -   |
| Serial number             | Displays the B&R serial number.   | None                  | -   |
| Product name              | Displays the B&R model number.  | None                  | -   |
| Parent device ID          | Displays the manufacturer number.   | None                  | -   |
| Parent Compatibility ID   | Displays the manufacturer ID.   | None                  | -   |
| <b>Statistical values</b> | Displays the statistical values.  | Enter                 | Opens this submenu<br>See "Statistical values" on page 201. |

## 7.1.6.1.5.1 Statistical values

| Phoenix SecureCore Technology Setup  |  |  |
|--|--|--|
| Advanced   |  |  |
| Statistical Values   |  |  |
| Operating Time<br>Total Hours                15<br>Power On Cycles            3  |  |  |
| F1 Help   ↕ Select Item +/-    Change Values            F9 Setup Defaults<br>ESC Exit   ↔ Select Menu    Enter Select > Sub-Menu   F10 Save and Exit |  |  |

| BIOS setting    | Explanation   | Configuration options | Effect |
|-----------------|---|-----------------------|--------|
| Total hours     | Displays the runtime in hours.  | None                  | -      |
| Power on cycles | Displays the power on cycles - Each restart increases the counter by one. | None                  | -      |

## 7.1.6.2 CPU configuration

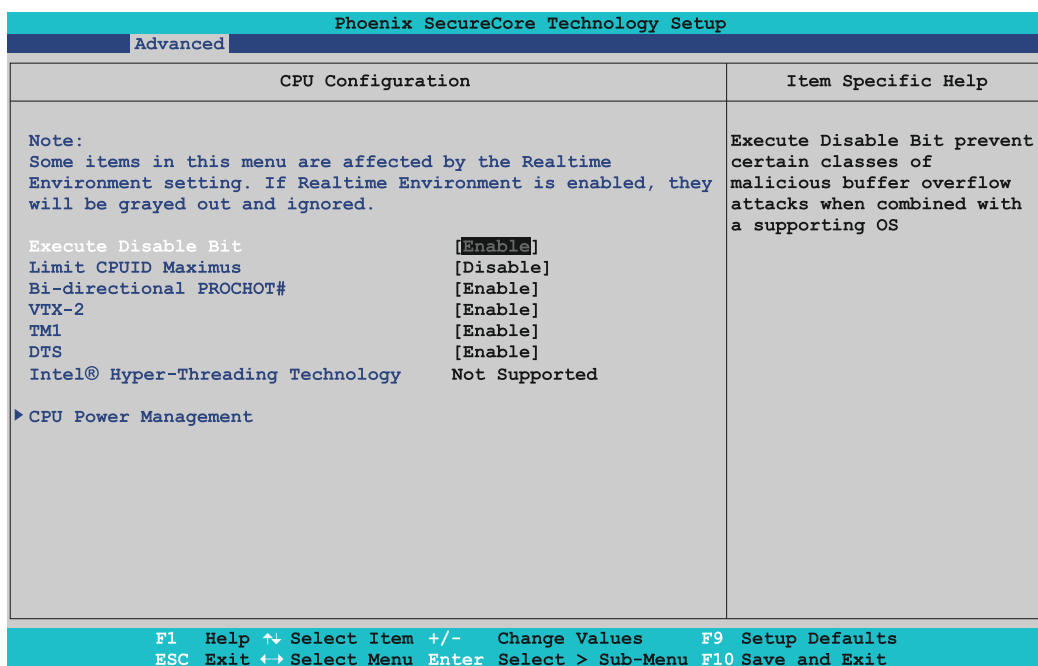

| BIOS setting                          | Explanation   | Configuration options | Effect   |
|---------------------------------------|---|-----------------------|--|
| Execute disable bit                   | Option for enabling/disabling hardware support for prevention of data execution.  | Disabled              | Disables this function.  |
|                                       |   | <b>Enabled</b>        | Enables this function.   |
| Limit CPUID maximum                   | Option for limiting the CPU ID value. This may be necessary for older operating systems that do not support CPUID functions.  | <b>Disabled</b>       | The processor returns the current maximum value when the CPU ID value is requested.                          |
|                                       |   | Enabled               | If necessary, the processor limits the maximum CPU ID value to 03h if the processor supports a higher value. |
| Bi-directional PROCHOT# <sup>1)</sup> | Option for enabling/disabling the PROCHOT signal. The PROCHOT signal initializes temperature throttling so that the CPU can be slowed down and protected against overheating. | Disabled              | Disables this function. Only the processor cores can enable the PROCHOT signal and throttle the processor.   |
|                                       |   | <b>Enabled</b>        | Enables this function. External services can enable the PROCHOT signal and choke the processor.              |
| VTX-2                                 | Option for enabling/disabling a virtual machine.  | Disabled              | Disables this function.  |
|                                       | <p><b>Information:</b></p> <p>A restart is required in order to apply changes made to this setting.</p>   | <b>Enabled</b>        | If this function is enabled, a virtual machine can use the additional hardware capacity.                     |
| TM1                                   | Option for setting the temperature monitoring.  | Disabled              | The temperature monitoring is disabled.  |
|                                       |   | <b>Enabled</b>        | Intel thermal mode 1 is enabled. If the CPU temperature is too high, the processor speed is reduced by 50%.  |
| DTS                                   | Option for enabling/disabling the CPU digital thermal sensor function.  | Disabled              | Disables this function.  |
|                                       |   | <b>Enabled</b>        | Enables this function.   |
| Intel Hyper-Threading Technology      | Displays whether Intel Hyper-Threading Technology is supported.   | None                  | -  |
| <b>CPU power management</b>           | Configures CPU energy settings.   | Enter                 | Opens this submenu<br>See "CPU power management" on page 203.  |

1) PROCHOT = Processor Hot

## 7.1.6.2.1 CPU power management

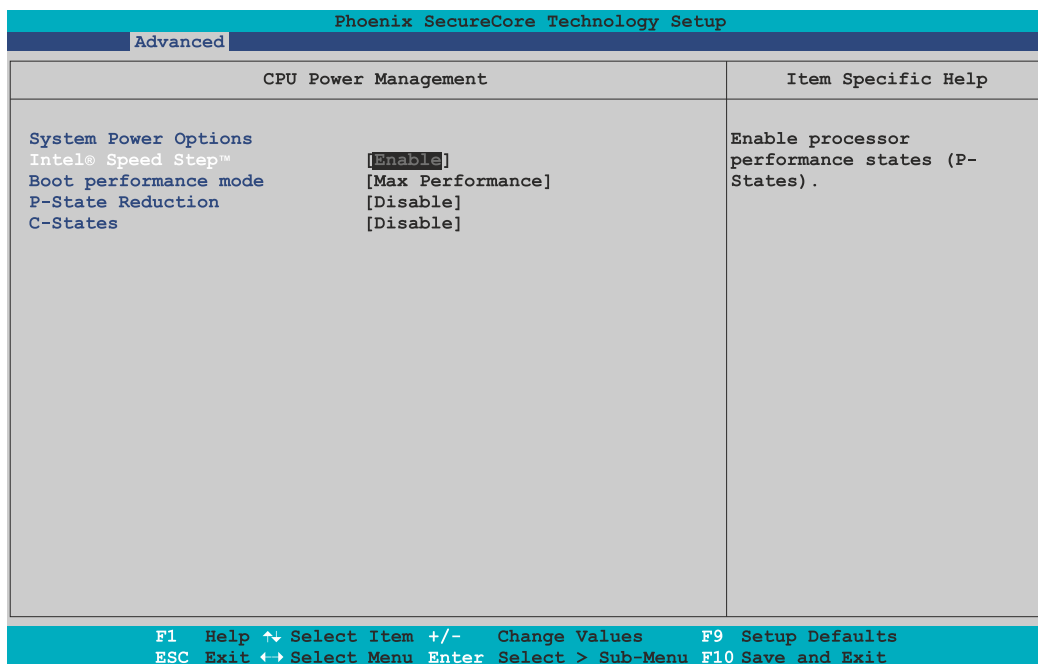

| BIOS setting               | Explanation  | Configuration options     | Effect   |
|----------------------------|--|---------------------------|--|
| Intel SpeedStep            | Option for controlling Intel SpeedStep Technology. The processor is clocked up or down according to the number of calculations to be performed. As a result, the energy consumption depends heavily on the utilization of the processor. | Disabled                  | Disables this function.  |
|                            |  | <b>Enabled</b>            | The processor speed is controlled by the operating system.                       |
| Boot performance mode      | Option for setting the CPU speed.<br><br><b>Information:</b><br><br>This setting can be changed in ACPI operating systems by enabling Intel SpeedStep Technology.  | <b>Max performance</b>    | Maximum CPU and graphics speed.  |
|                            |  | Max battery               | The CPU and graphics speed is choked.  |
| P-state reduction          | Option for reducing CPU performance and power usage.   | <b>Disabled</b>           | Disables this function.  |
|                            |  | By 1, 2, 3, 4, 5, 6, 7, 8 | Reduces the performance by the configured value depending on the CPU being used. |
| C-states                   | This setting allows the operating system to set the clock frequency of the processor itself. This saves energy.  | <b>Disabled</b>           | Disables this function.  |
|                            |  | <b>Enabled</b>            | Enables this function; additional settings can be made.                          |
| Max C states <sup>1)</sup> | This setting controls the maximum C state that the processor supports.   | C7                        | Maximum C state C7. The CPU voltage is completely switched off.                  |
|                            |  | C6                        | Maximum C state C6. The CPU voltage is reduced to almost 0 V.                    |
|                            |  | C1                        | Maximum C state C1. The processor is in sleep mode. Switch between C0 and C1.    |

1) This setting is only possible if C-states is set to *Enabled*.

## 7.1.6.3 Graphics (IGD) configuration

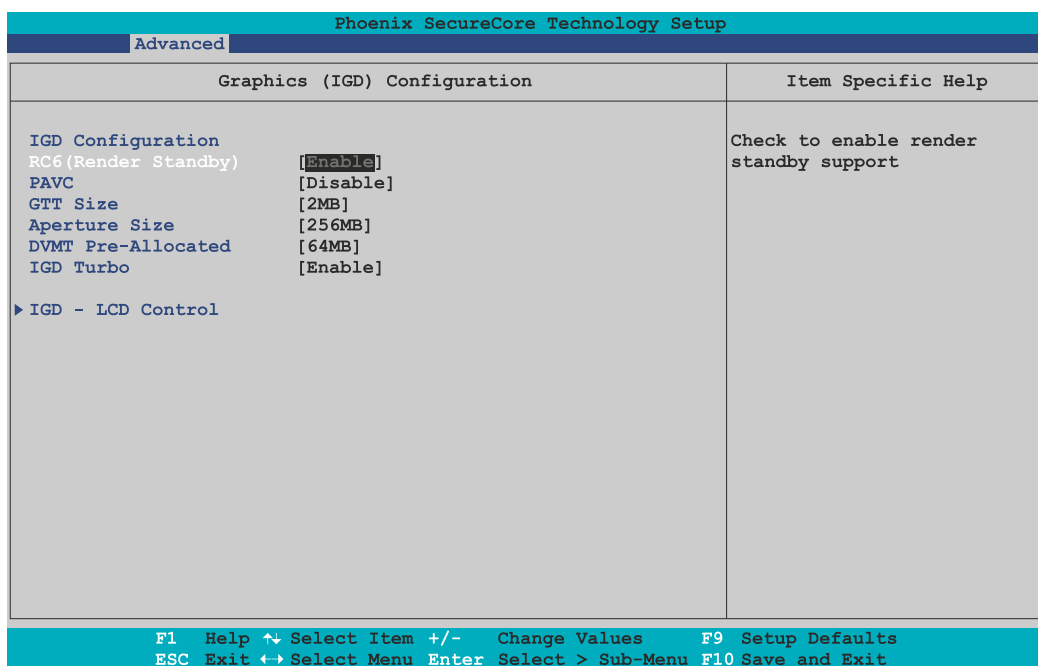

| BIOS setting             | Explanation  | Configuration options   | Effect   |
|--------------------------|--|---|--|
| RC6 (render standby)     | Option for enabling/disabling standby mode for the onboard graphics in order to consume less energy.         | Disabled  | Disables this function.  |
|                          |  | <b>Enabled</b>  | Enables this function.   |
| PAVC                     | Protected Audio Video Control protects data on the PC.   | <b>Disabled</b>   | Disables this function.  |
|                          |  | LITE mode   | Reserves the memory.   |
|                          |  | SERPENT mode  | Reserves the memory; this is not recognized by the operating system. |
| GTT size                 | Option for setting the size of the graphics translation table (GTT).   | 1 MB  | 1 MB GTT   |
|                          |  | <b>2 MB</b>   | 2 MB GTT   |
| Aperture size            | Option for setting the maximum amount of RAM made available to the main memory when graphics memory is full. | 128 MB  | Reserves 128 MB  |
|                          |  | <b>256 MB</b>   | Reserves 256 MB  |
|                          |  | 512 MB  | Reserves 512 MB  |
| DVMT pre-allocated       | Option for setting the fixed memory size used for the internal graphics controller.                          | <b>64 M</b> , 96 M, 128 M, 160 M, 192 M, 224 M, 256 M, 288 M, 320 M, 352 M, 384 M, 416 M, 448 M, 480 M, 512 M | Defines the static graphics memory as a value between 64 and 512 MB. |
| IGD turbo                | Option for setting the turbo boost on the graphics controller.   | Disabled  | Disables this function.  |
|                          |  | <b>Enabled</b>  | Enables this function.   |
| <b>IGD - LCD control</b> | Configures the display settings of the PPC2100.  | Enter   | Opens this submenu<br>See "IGD - LCD control" on page 205.           |

## 7.1.6.3.1 IGD - LCD control

| Phoenix SecureCore Technology Setup  |   |  |
|--|---|--|
| Advanced   |   |  |
| IGD Configuration  | Item Specific Help  |  |
| IGD managed by:<br>Legacy Video BIOS [3798]  | Select the Video Device activated during POST. This has no effect if external graphics are present. |  |
| <b>LVDS EEPROM Data</b><br>Data Format                      EPI<br>Resolution                        1024x768<br>Color Depth                      24Bit<br>Channel Count                    Single Channel |   |  |
| IGD - Boot Type <b>[Auto]</b>  |   |  |
| LVDS Clock Center Spreading <b>[No Spreading]</b><br>Firmware PLL Range <b>[Auto]</b>  |   |  |
| EFP1 Type <b>[DP with HDMI/DVI]</b>  |   |  |
| Mode Persistence <b>[Disable]</b><br>Center Mode <b>[Auto]</b>   |   |  |
| F1 Help   ↕ Select Item +/-   Change Values    F9 Setup Defaults<br>ESC Exit   ← Select Menu   Enter Select > Sub-Menu   F10 Save and Exit   |   |  |

| BIOS setting                            | Explanation   | Configuration options                             | Effect   |
|---|---|---|--|
| Data format                             | Displays the data format of the LFP <sup>1)</sup> .   | None  | -  |
| Resolution                              | Displays the display resolution of the LFP.   | None  | -  |
| Color depth                             | Displays the color depth of the LFP display.  | None  | -  |
| Channel count                           | Displays LFP channels.  | None  | -  |
| IGD - Boot type                         | Option for defining the primary enabled display device during POST.   | <b>Auto</b>                                       | Automatic selection.   |
|   |   | CRT   | The CRT (cathode ray tube) channel is used.  |
|   |   | EFP   | The EFP (external flat panel) channel is used.   |
|   |   | LFP   | The LFP (local flat panel) channel is used.  |
| IGD - Secondary boot type <sup>2)</sup> | Option for defining the secondary enabled display device during POST.<br><br><b>Information:</b><br><br><b>After the BIOS boot screen, this display and BIOS will no longer show anything until the graphics driver is re-loaded by the operating system.</b>   | Disabled  | Disables this function.  |
|   |   | CRT   | The CRT (cathode ray tube) channel is used.  |
|   |   | EFP   | The EFP (external flat panel) channel is used.   |
|   |   | LFP   | The LFP (local flat panel) channel is used.  |
| LFP type <sup>3)</sup>                  | Option for manually setting the LFP (local flat panel) type.  | Auto  | The LFP type is automatically set based on the EDID data.                                  |
|   |   | VGA 640 x 480 1x18 up to WUXGA 1920 x 1200 2 x 24 | Manual adjustment of the resolution from 640 x 480 to 1920 x 1200.                         |
| LVDS clock center spreading             | Option for modulating the LVDS clock frequency to slightly reduce electromagnetic interference.   | <b>No spreading</b>                               | Disables this function.  |
|   |   | 0.5%, 1.0%, 1.5%, 2.0%, 2.5%                      | The LVDS clock frequency varies around the set value and the EMC behavior can be improved. |
| Firmware PLL Range                      | Option for manual setting of the phase-locked loop.   | <b>Auto</b>                                       | The system uses 0x03 for SVGA resolution and 0x02 for all other resolutions.               |
|   |   | 1.56%, 3.12%, 6.5%, 12.5%, 25%, 50%, 100%         | Set manually.  |
| EFP1 type <sup>4)</sup>                 | Option for setting the type for external flat panel 1.  | DisplayPort only                                  | Configures the interface as a DisplayPort interface.                                       |
|   |   | <b>DP with HDMI/DVI</b>                           | The interface is configured as a DisplayPort with HDMI/DVI.                                |
|   |   | HDMI/DVI  | Configures the interface as an HDMI/DVI.   |
| Mode "Persistence"                      | Mode "Persistence" means that the operating system can remember and restore past display connection configurations.<br>For example, a dual DVI display configuration is automatically restored when both DVI monitors are reconnected, even if only one DVI monitor was connected and activated during a previous boot procedure. | <b>Disabled</b>                                   | Disables this function.  |
|   |   | Enabled   | Enables this function.   |

| BIOS setting | Explanation  | Configuration options | Effect   |
|--------------|--|-----------------------|--|
| Center mode  | For panels without a scaler chip, the image is centered. | Disabled              | Disables this function.                                  |
|              |  | <b>Auto</b>           | Enables this function for all connected panels/monitors. |
|              |  | CRT                   | Enables this function for CRT monitors.                  |
|              |  | EFP                   | Enables this function for panels.                        |

- 1) LFP = Local flat panel
- 2) This setting is only possible if *IGD - Boot type* is set to *CRT*, *EFP* or *LFP*.
- 3) This setting is only possible if *IGD - Boot type* is set to *LFP*.
- 4) This setting is only possible if *IGD - Boot type* is set to *Auto* or *EFP*.

### 7.1.6.4 LAN

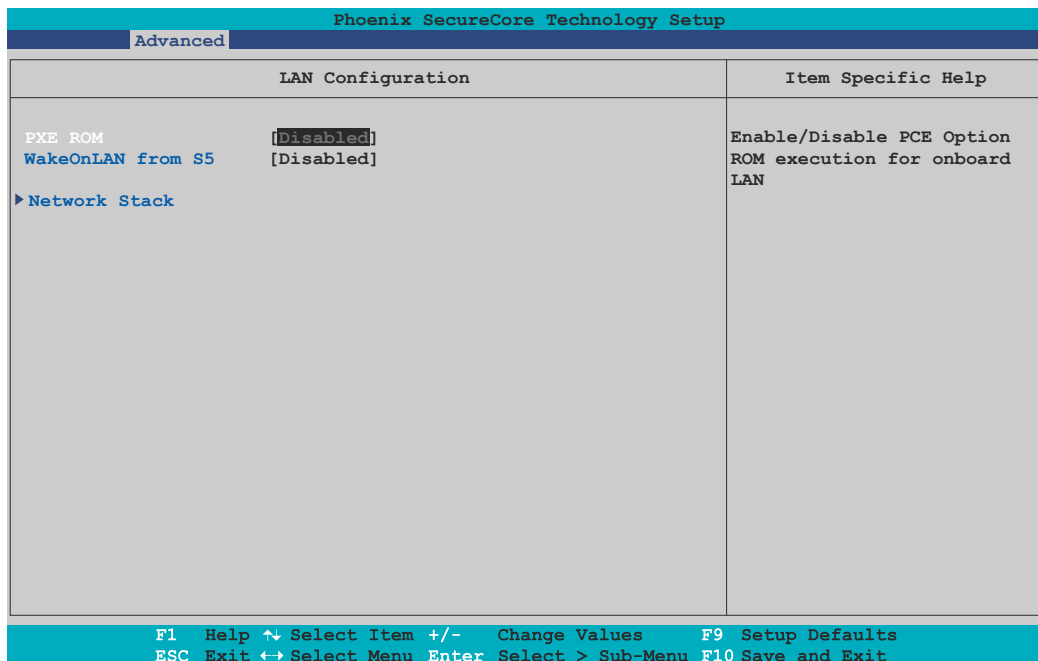

| BIOS setting      | Explanation  | Configuration options | Effect   |
|-------------------|--|-----------------------|--|
| PXE ROM           | Option for setting the PXE boot features.  | <b>Disabled</b>       | Disables this function.  |
|                   |  | Onboard ETH1 only     | Enables this function for ETH1.  |
|                   |  | Onboard ETH2 only     | Enables this function for ETH2.  |
|                   |  | Both onboard only     | Enables this function for ETH1 and ETH2.                                     |
|                   |  | Add-on only           | Enables this function for an optionally connected add-on card.               |
|                   |  | Any                   | Enables this function for all devices, ETH1 and ETH2.                        |
| WakeOnLAN from S5 | Option for switching on the system via the on-board Ethernet controller (ETH1) from mode S5. | Disabled              | Disables this function. The Ethernet controller cannot switch on the system. |
|                   |  | <b>Enabled</b>        | Enables this function. The Ethernet controller can switch on the system.     |
| Network stack     | Configures the network stack   | Enter                 | Opens submenu "Network stack" on page 207                                    |

### 7.1.6.4.1 Network stack

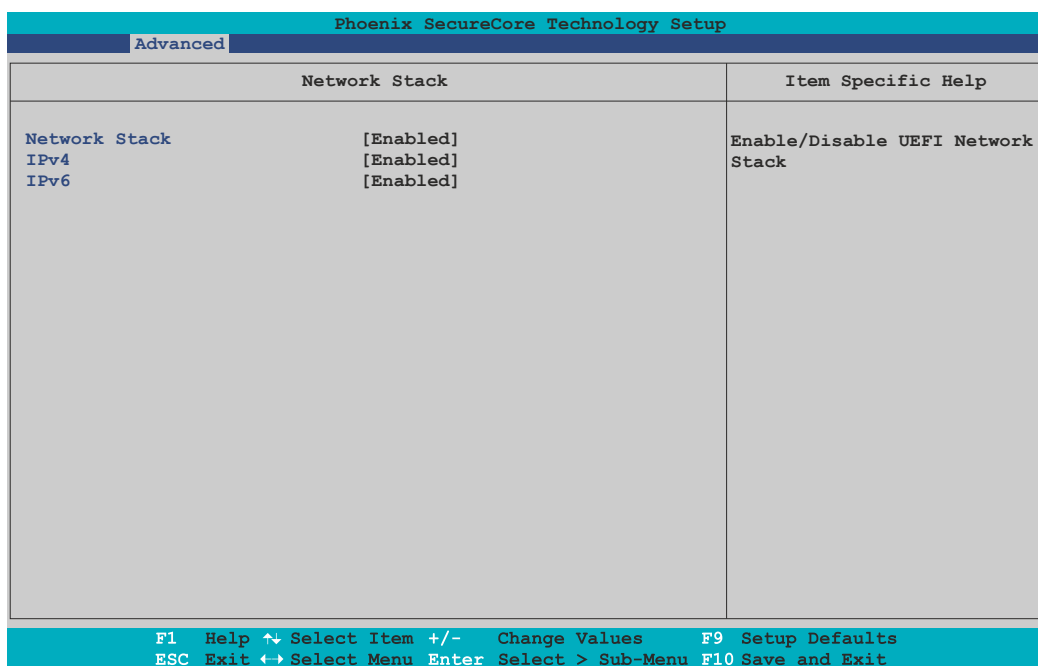

| BIOS setting  | Explanation  | Configuration options | Effect                  |
|---------------|--|-----------------------|-------------------------|
| Network stack | Option for enabling/disabling the UEFI network stack | Disabled              | Disables this function. |
|               |  | Enabled               | Enables this function.  |
| IPv4          | Option for enabling/disabling IPv4 PXE support.      | Enabled               | Enables this function.  |
|               |  | Disabled              | Disables this function. |
| IPv6          | Option for enabling/disabling IPv6 PXE support.      | Enabled               | Enables this function.  |
|               |  | Disabled              | Disables this function. |

### 7.1.6.5 PCI express configuration

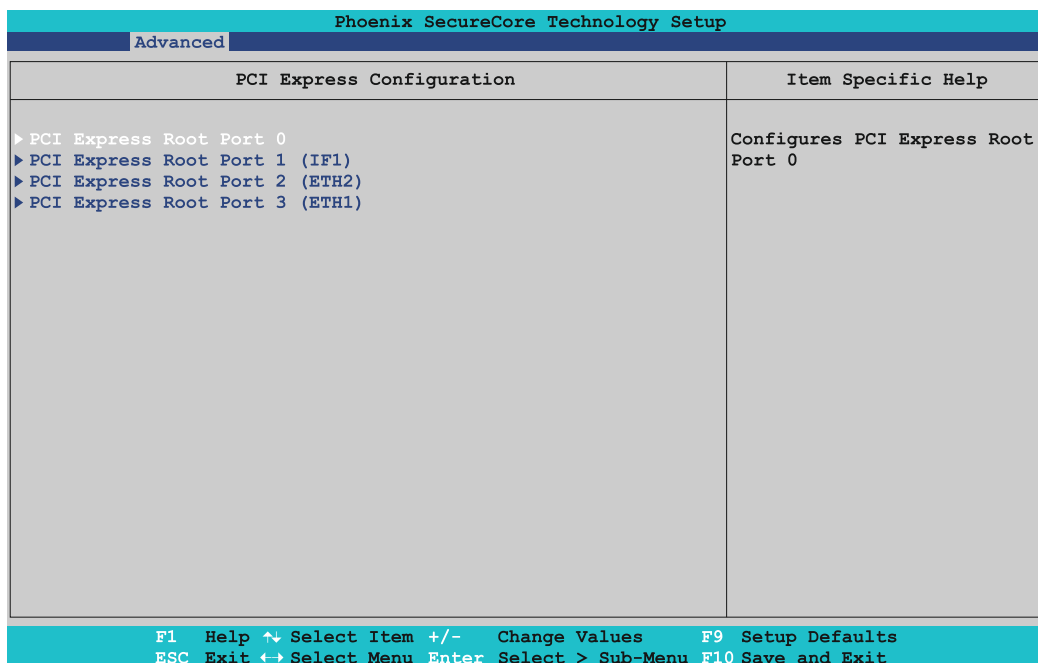

## Software

| BIOS setting                   | Explanation   | Configuration options | Effect  |
|--------------------------------|---|-----------------------|---|
| PCI Express root port 0        | Configures PCI Express settings on port 0.                    | Enter                 | Opens this submenu<br>See "PCI Express root port 0 to 3" on page 208. |
| PCI Express root port 1 (IF1)  | Configures PCI Express settings on port 1 (interface option). | Enter                 | Opens this submenu<br>See "PCI Express root port 0 to 3" on page 208. |
| PCI Express root port 2 (ETH2) | Configures PCI Express settings on port 2 (ETH2).             | Enter                 | Opens this submenu<br>See "PCI Express root port 0 to 3" on page 208. |
| PCI Express root port 3 (ETH1) | Configures PCI Express settings on port 3 (ETH1).             | Enter                 | Opens this submenu<br>See "PCI Express root port 0 to 3" on page 208. |

### 7.1.6.5.1 PCI Express root port 0 to 3

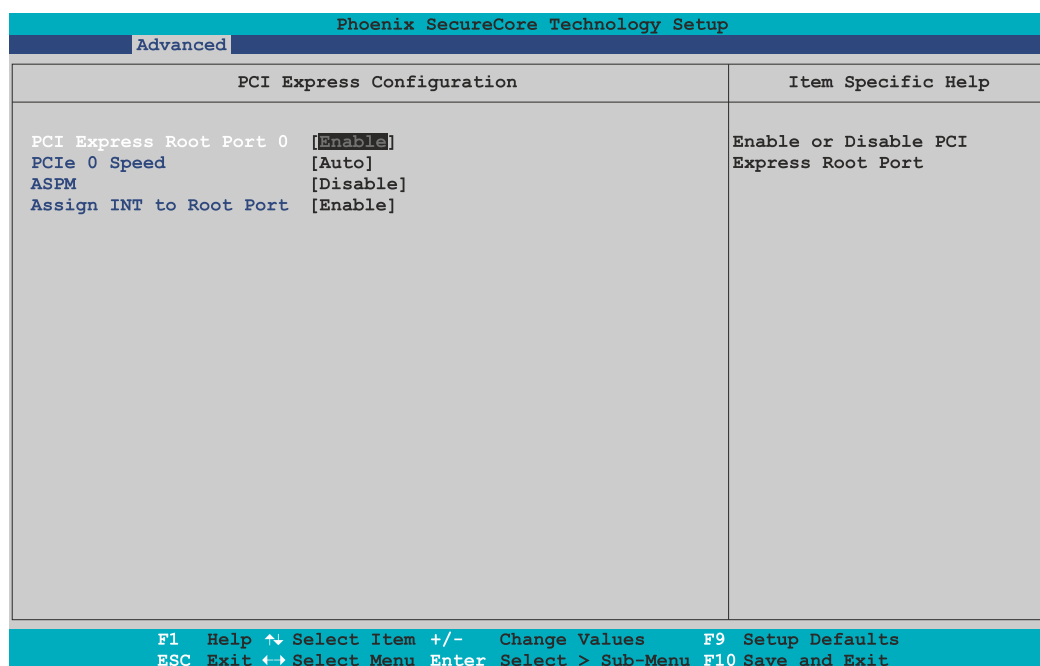

| BIOS setting            | Explanation   | Configuration options | Effect  |
|-------------------------|---|-----------------------|---|
| PCI Express root port x | Option for enabling/disabling the PCI Express root port x.  | <b>Enabled</b>        | Enables the PCI Express root port.  |
|                         |   | Disabled              | Disables the PCI Express root port.   |
| PCIe x speed            | Option for setting the PCI Express transfer rate.   | <b>Auto</b>           | Automatically sets the transfer rate.                                       |
|                         |   | Gen1                  | Maximum transfer rate = 2.5 GT/s.   |
|                         |   | Gen2                  | Maximum transfer rate = 5 GT/s.   |
| ASPM                    | <i>Active State Power Management</i><br>Option for setting a power saving function (L0s/L1) for PCIe devices if they do not require full power. | <b>Disabled</b>       | Disables this function.   |
|                         |   | L0s                   | Enables the L0 energy saving function.                                      |
|                         |   | L0sL1                 | Automatic assignment of L0s or L1 power saving function by the PCIe device. |
| Assign INT to root port | Option for enabling/disabling the IRQ for the root port.  | <b>Auto</b>           | Automatic assignment by BIOS and the operating system.                      |
|                         |   | <b>Enabled</b>        | Enables this function.  |
|                         |   | Disabled              | Disables this function.   |

## 7.1.6.6 USB configuration

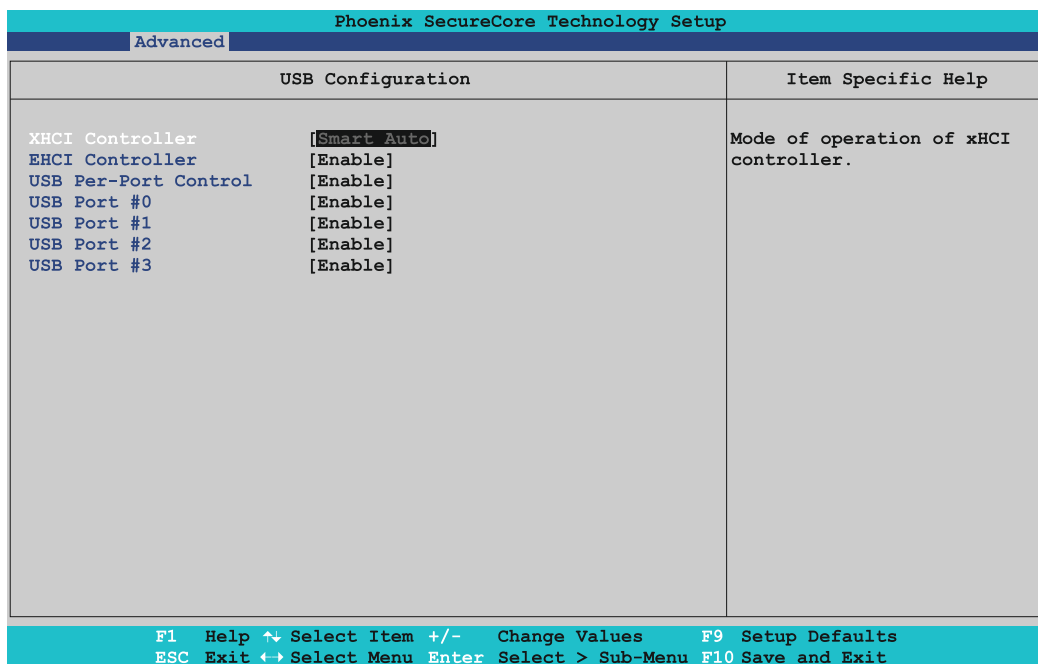

| BIOS setting         | Explanation  | Configuration options | Effect   |
|----------------------|--|-----------------------|--|
| XHCI controller      | Option for setting the xHCI controllers.   | <b>Smart auto</b>     | The USB 3.0 interfaces are only treated as USB 3.0 when the operating system is started; until then, they are treated as USB 2.0 interfaces. If the PC is rebooted, then the USB 3.0 interfaces are handled as USB 3.0 during booting. |
|                      |  | Disabled              | The xHCI controller is disabled. All USB 3.0 interfaces become USB 2.0 interfaces.   |
|                      |  | Enabled               | The xHCI controller is enabled and the USB 3.0 interfaces are always recognized as such.   |
| EHCI controller      | Sets the USB EHCI controller for the USB ports.                                    | Disabled              | Disables the EHCI controller.  |
|                      |  | <b>Enabled</b>        | Enables the EHCI controller.   |
| USB per-port control | Option for enabling/disabling individual USB ports.                                | Disabled              | The BIOS settings "USB port #x" are hidden.  |
| USB port #0          | Option for enabling/disabling the USB1 port.                                       | <b>Enabled</b>        | The BIOS settings "USB port #x" are displayed.   |
|                      |  | Disabled              | The USB port is disabled.  |
| USB port #1          | Option for enabling/disabling the USB2 port.                                       | <b>Enabled</b>        | The USB port is enabled.   |
|                      |  | Disabled              | The USB port is disabled.  |
| USB port #2          | Option for enabling/disabling the multi-touch or the optional front USB interface. | <b>Enabled</b>        | The USB port is enabled.   |
|                      |  | Disabled              | The USB port is disabled.  |
| USB port #3          | Option for enabling/disabling the multi-touch or the optional front USB interface. | <b>Enabled</b>        | The USB port is enabled.   |
|                      |  | Disabled              | The USB port is disabled.  |

## 7.1.6.7 SATA configuration

| Phoenix SecureCore Technology Setup   |  |
|---|--|
| Advanced  |  |
| SATA Configuration  | Item Specific Help                               |
| Chipset SATA <span style="float: right;">[Enable]</span><br>Chipset SATA Mode <span style="float: right;">[AHCI]</span><br>SATA Port 0 Hot Plug Capability <span style="float: right;">[Disable]</span><br>SATA Port 1 Hot Plug Capability <span style="float: right;">[Disable]</span> | Enables or Disables the Chipset SATA Controller. |
| F1 Help ↕ Select Item +/- Change Values F9 Setup Defaults<br>ESC Exit ↔ Select Menu Enter Select > Sub-Menu F10 Save and Exit   |  |

| BIOS setting                    | Explanation  | Configuration options | Effect   |
|---------------------------------|--|-----------------------|--|
| Chipset SATA                    | Option for setting the SATA support.                 | Enabled               | Provides support for SATA devices.   |
|                                 |  | Disabled              | No support for SATA devices.   |
| Chipset SATA mode               | Option for setting supported serial ATA connections. | IDE                   | The serial ATA hard disk is used as a parallel ATA physical disk drive. It is not possible to configure the SATA ports.  |
|                                 |  | AHCI                  | The AHCI setting enables the internal memory driver for SATA functions, which increases the storage performance for random read-write access by allowing the drive itself to determine the sequence of commands. |
| SATA Port 0 hot plug capability | Option for setting the hot plugging for SATA port 0. | Enabled               | Enables hot plugging for SATA interface 0. Devices can be connected/disconnected during operation.   |
|                                 |  | Disabled              | Disables hot plugging for SATA port 0.   |
| SATA Port 1 hot plug capability | Option for setting the hot plugging for SATA port 1. | Enabled               | Enables hot plugging for SATA interface 1. Devices can be connected/disconnected during operation.   |
|                                 |  | Disabled              | Disables hot plugging for SATA port 1.   |

## 7.1.6.8 Miscellaneous configuration

| Phoenix SecureCore Technology Setup   |  |
|---|--|
| Advanced  |  |
| Miscellaneous Configuration   | Item Specific Help                               |
| Realtime Environment <span style="float: right;">[Disabled]</span><br>Hypervisor Environment <span style="float: right;">[Disabled]</span><br>PCI MMIO Size <span style="float: right;">[Auto]</span><br>Extended Temperature Range <span style="float: right;">[Disabled]</span> | Enable or Disable the High Precision Event Timer |
| F1 Help ↕ Select Item +/- Change Values F9 Setup Defaults<br>ESC Exit ↔ Select Menu Enter Select > Sub-Menu F10 Save and Exit   |  |

| BIOS setting               | Explanation  | Configuration options                    | Effect  |
|----------------------------|--|--|---|
| Realtime environment       | Configures settings for real-time operating systems such as Automation Runtime.  | Disabled                                 | Disables this function.   |
|                            |  | Enabled                                  | Disables DTS, turbo boost, SpeedStep, ASPM and the INT of root port 1 (IF). In addition, the CPU C-states are disabled and the boot performance mode is set to "Max. performance".<br><br>Starting with BIOS V1.41, parameter "RC6" (render standby) is also disabled.<br><br>The options that are configured and disabled by the real-time environment are grayed out and cannot be changed. |
| Hypervisor environment     | This option configures settings for hypervisor operation.  | Disabled                                 | Disables this function.   |
|                            |  | Enabled                                  | VTX (Virtualization Technology) is enabled. The options that are configured by the hypervisor environment are grayed out and cannot be changed.   |
| PCI MMIO size              | Option for setting the PCI MMIO (memory mapped IO) size.<br><br><b>Information:</b><br><br>With 32-bit operating systems, the set MMIO size is stored under 4 GB in memory. This means that systems with 4 GB of main memory have less MMIO size available.<br><br>This is not the case with 64-bit operating systems. | 2 GB, 1.5 GB, 1.25 GB, 1 GB, <b>Auto</b> | Sets the selected memory size.  |
| Extended temperature range | Option for setting the RAM refresh rate for extended temperature.  | Disabled                                 | Default RAM refresh rate.   |
|                            |  | Enabled                                  | Increases the RAM refresh rate.   |

### 7.1.6.9 Thermal configuration

| Phoenix SecureCore Technology Setup  |   |
|--|---|
| Advanced   |   |
| Thermal Configuration  | Item Specific Help  |
| Thermal Configuration Parameters<br>Critical Trip Point <span style="border: 1px solid black; padding: 2px;">[+103°C / +217°F]</span><br>Passive Trip Point <span style="border: 1px solid black; padding: 2px;">[+95°C / +203°F]</span> | This value controls the temperature of the ACPI Critical Trip Point - the point in which the OS will shut the system off. |
| F1 Help ↕ Select Item +/- Change Values F9 Setup Defaults<br>ESC Exit ↔ Select Menu Enter Select > Sub-Menu F10 Save and Exit  |   |

| BIOS setting        | Explanation   | Configuration options   | Effect   |
|---------------------|---|---|--|
| Critical trip point | This function sets the CPU temperature at which the operating system automatically shuts down the PC. | 15°C / 59°F,<br>23°C / 73°F,<br>31°C / 88°F,<br>39°C / 102°F,<br>47°C / 117°F,<br>55°C / 131°F,<br>63°C / 145°F,<br>71°C / 160°F,<br>79°C / 174°F,<br>85°C / 185°F,<br>87°C / 189°F,<br>90°C / 194°F,<br>95°C / 203°F,<br><b>103°C / 217°F</b> ,<br>111°C / 232°F | Temperature setting for the critical trip point. |
|                     |   | Disabled  | Disables this function.                          |
| Passive trip point  | Function for setting a CPU temperature at which the operating system throttles the CPU speed.         | 15°C / 59°F,<br>23°C / 73°F,<br>31°C / 88°F,<br>39°C / 102°F,<br>47°C / 117°F,<br>55°C / 131°F,<br>63°C / 145°F,<br>71°C / 160°F,<br>79°C / 174°F,<br>85°C / 185°F,<br>87°C / 189°F,<br>90°C / 194°F,<br><b>95°C / 203°F</b> ,<br>103°C / 217°F                   | Temperature setting for the passive trip point.  |
|                     |   | Disabled  | Disables this function.                          |

## 7.1.7 Security

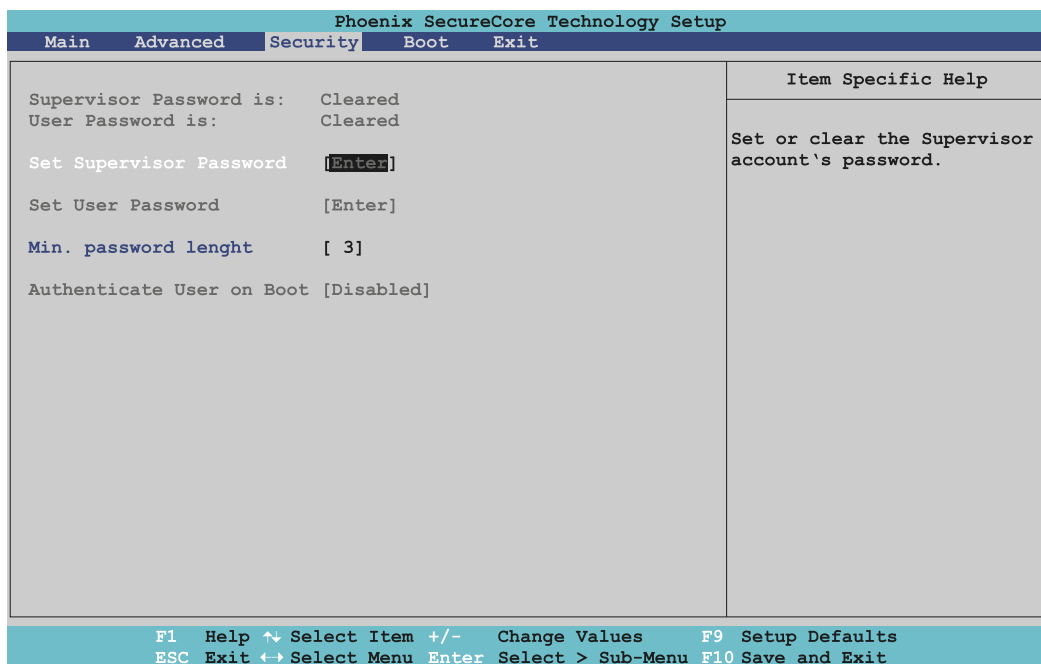

| BIOS setting                            | Explanation  | Configuration options | Effect   |
|---|--|-----------------------|--|
| Supervisor password is:                 | Indicates whether a supervisor password has been assigned.   | None                  | -  |
| User password is:                       | Indicates whether a user password has been assigned.   | None                  | -  |
| Set supervisor password                 | Function for entering, changing and deleting a supervisor password. All BIOS settings can only be edited with the supervisor password. | Enter                 | Password entry.  |
| Set user password <sup>1)</sup>         | Function for entering, changing and deleting a user password. With the supervisor password, only certain BIOS settings can be edited.  | Enter                 | Password entry.  |
| Min. password length                    | Function for setting the minimum password length.  | 3 to 20               | Enter the minimum password length.                         |
| Authenticate user on boot <sup>1)</sup> | Option for setting whether the user password must be entered for each boot procedure.  | Disabled              | A user password is not required for the boot procedure.    |
|   |  | Enabled               | The user password must be entered for each boot procedure. |

1) The setting can only be set if a *supervisor password* is assigned.

## 7.1.8 Boot

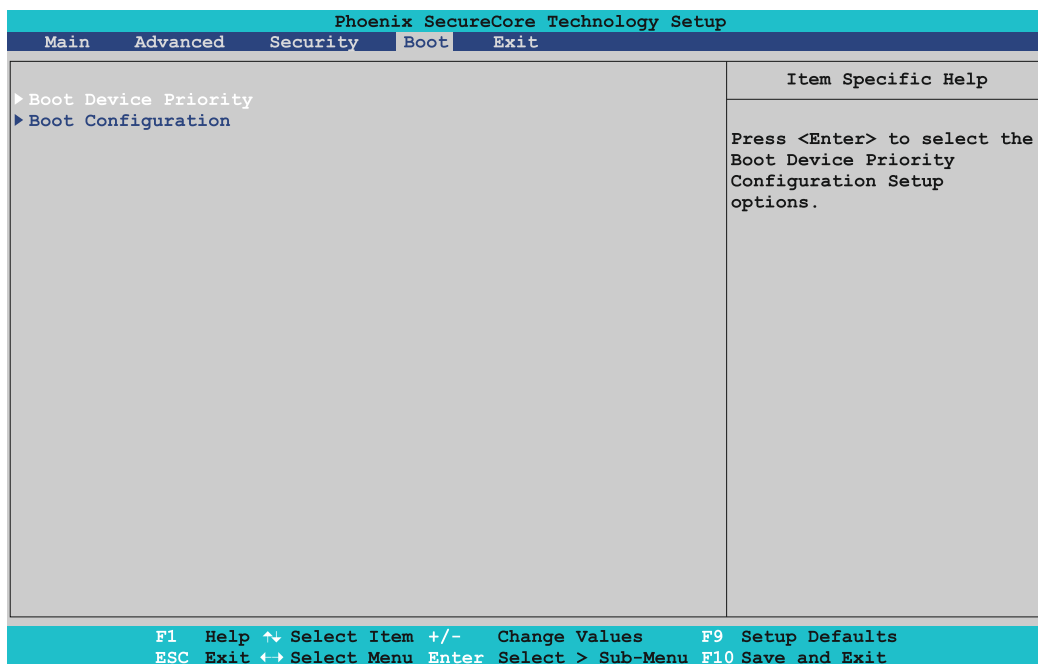

| BIOS setting         | Explanation                   | Configuration options | Effect  |
|----------------------|-------------------------------|-----------------------|---|
| Boot device priority | Configures the boot sequence. | Enter                 | Opens this submenu<br>See "Boot device priority" on page 214. |
| Boot configuration   | Configures boot settings.     | Enter                 | Opens this submenu<br>See "Boot configuration" on page 215.   |

### 7.1.8.1 Boot device priority

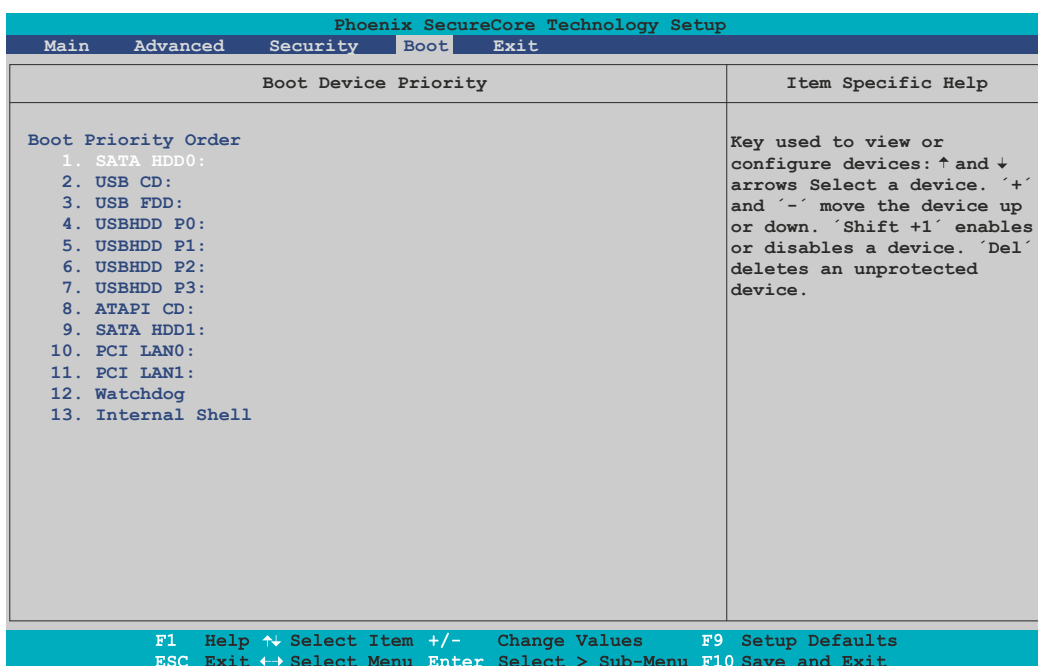

| BIOS setting        | Explanation                                   | Configuration options  | Effect   |
|---------------------|---|------------------------|--|
| Boot priority order | Option for setting the desired boot sequence. | SATA HDD0:             | Specifies the desired boot sequence.<br><br>Boot devices can be selected with the ↑ and ↓ arrow keys. Use "+" and "-" to change the sequence. "Shift + 1" activates/deactivates a boot device. |
|                     |   | USB CD:                |  |
|                     |   | USB FDD:               |  |
|                     |   | USBHDD P0:             |  |
|                     |   | USBHDD P1:             |  |
|                     |   | USBHDD P2:             |  |
|                     |   | USBHDD P3:             |  |
|                     |   | ATAPI CD:              |  |
|                     |   | SATA HDD1:             |  |
|                     |   | PCI LAN0:              |  |
|                     |   | PCI LAN1:              |  |
|                     |   | Watchdog <sup>1)</sup> |  |
| Internal shell      |   |                        |  |

- 1) This watchdog can be used for sporadic recognition problems with CFast cards. If such a case occurs, a reset is triggered. If boot problems occur with SATA devices, their firmware version must be checked and updated if necessary.

### 7.1.8.2 Boot configuration

| Phoenix SecureCore Technology Setup |                |                                    |
|-------------------------------------|----------------|------------------------------------|
| Boot                                |                |                                    |
| Boot Configuration                  |                | Item Specific Help                 |
| NumLock                             | [On]           | Selects Power-on state of Numlock. |
| Timeout                             | [ 2]           |                                    |
| CSM Support                         | [Yes]          |                                    |
| Quick Boot                          | [Disabled]     |                                    |
| Boot Logo Selection                 | [Auto]         |                                    |
| Diagnostic Splash Screen            | [Disabled]     |                                    |
| Diagnostic Summary Screen           | [Disabled]     |                                    |
| USB Legacy Support                  | [Enabled]      |                                    |
| Console Redirection                 | [Disabled]     |                                    |
| Allow Hotkey in S4 resume           | [Enabled]      |                                    |
| UEFI Boot                           | [Enabled]      |                                    |
| Legacy Boot                         | [Enabled]      |                                    |
| Boot in Legacy Video Mode           | [Disabled]     |                                    |
| Load OPROM                          | [On Demand]    |                                    |
| Boot Priority                       | [Legacy First] |                                    |
| EFI BS Memory Allocation            | [Disabled]     |                                    |

F1 Help ↕ Select Item +/- Change Values F9 Setup Defaults  
ESC Exit ↔ Select Menu Enter Select > Sub-Menu F10 Save and Exit

| BIOS setting              | Explanation   | Configuration options | Effect  |
|---------------------------|---|-----------------------|---|
| NumLock                   | Option for setting the numeric keypad when booting the system.  | On                    | Enables the numeric keypad.   |
|                           |   | Off                   | Only enables the cursor (movement) functions of the numeric keypad.   |
| Timeout                   | Option for setting how long the setup activation key (key for entering BIOS) and boot logo is displayed.  | 2 to 99               | Displays the setup activation key for x seconds.  |
| CSM support               | The compatibility support module (BIOS compatibility mode) supports backward compatibility for legacy BIOS settings of the legacy boot depending on the operating system. | Yes                   | BIOS compatibility mode is enabled and operating systems without UEFI support can be used. Legacy and UEFI boot are possible. |
|                           |   | No                    | The BIOS compatibility mode is enabled and only the UEFI boot is possible. Legacy boot is not supported.                      |
| Quick boot                | This function reduces the boot time by skipping some POST procedures.   | Disabled              | Disables this function.   |
|                           |   | Enabled               | Enables this function.  |
| Boot logo selection       | Option for displaying the boot logo.  | Disabled              | The default logo is displayed.  |
|                           |   | Enabled               | The OEM logo is displayed.  |
|                           |   | Auto                  | The OEM logo is automatically displayed if it exists.   |
| Diagnostic splash screen  | Setting for enabling/disabling the "Diagnostic splash screen" during the boot procedure.  | Disabled              | The "Diagnostic splash screen" is not displayed.  |
|                           |   | Enabled               | The "Diagnostic splash screen" is always displayed during the boot procedure.   |
| Diagnostic summary screen | Option for enabling/disabling the "Diagnostic summary screen" during the boot procedure.  | Disabled              | Disables this function.   |
|                           |   | Enabled               | Enables this function.  |
| USB legacy support        | Option for setting the USB legacy support.  | Disabled              | Disables this function. The complete USB support is disabled (mouse, keyboard, USB mass storage, etc.).                       |
|                           |   | Enabled               | Enables this function.  |

| BIOS setting                            | Explanation   | Configuration options                          | Effect   |
|---|---|--|--|
| Console redirection                     | Option for setting the remote console. With the remote console, BIOS Setup can be accessed via the serial interface using a terminal emulator (PuTTY or HyperTerminal).<br><br><b>Information:</b><br><br>This function is only possible with IF option 5ACCIF01.FPLS-000 or 5ACCIF01.FPLS-001. | Disabled                                       | Disables this function.  |
|   |   | Enabled  | Enables this function.   |
| Console port <sup>1)</sup>              | Option for setting the serial interface.  | All  | Can be accessed via any serial interface.  |
|   |   | UART A, UART B, UART C, UART D, UART E, UART F | Accessed via the selected serial interface.  |
| Terminal type <sup>1)</sup>             | Option for setting keyboard input.  | ANSI   | Enables the ANSI convention (extended ASCII character set).  |
|   |   | VT100  | Enables the VT100 convention (ASCII character set).  |
|   |   | VT100+   | Enables the VT100+ convention (ASCII character set and support for color, function keys, etc.).                          |
|   |   | UTF8   | Enables the UTF-8 convention (uses UTF-8 encoding to assign Unicode characters to one or more bytes).                    |
| Baud rate <sup>1)</sup>                 | Option for setting the transfer rate of the serial interface (bits per second).   | 9600, 19200, 38400, 57600, 115200              | Enables a transfer rate of x bits  |
| Flow control <sup>1)</sup>              | Option for setting the data flow control.   | None   | Disables data flow control.  |
|   |   | RTS/CTS  | Enables hardware handshake.  |
|   |   | XON/XOFF                                       | Enables software handshake.  |
| Continue C.R. after POST <sup>1)</sup>  | Option for enabling/disabling console redirection after POST.   | Disabled                                       | Disables this function.  |
|   |   | Enabled  | Enables this function.   |
| Allow hotkey in S4 resume               | Option for enabling/disabling hotkey detection from the S4 state.   | Disabled                                       | Disables this function.  |
|   |   | Enabled  | Enables this function. The PC exits the S4 state when a key is pressed.  |
| UEFI boot                               | Option for enabling/disabling the UEFI boot.  | Disabled                                       | Disables this function.  |
|   |   | Enabled  | Enables this function.   |
| Legacy boot                             | Option for enabling/disabling the legacy boot.  | Disabled                                       | Disables this function.  |
|   |   | Enabled  | Enables this function.   |
| Boot in legacy video mode <sup>2)</sup> | Option for enabling/disabling graphic initialization after BIOS POST with legacy ROM.   | Disabled                                       | Disables this function.  |
|   |   | Enabled  | Enables this function.<br><br><b>Information:</b><br><br>Nothing is displayed after BIOS POST; the screen remains black. |
| Load OPROM <sup>2)</sup>                | Setting for loading all option ROMs or depending on the boot device.  | All  | All option ROMs are loaded.  |
|   |   | On demand                                      | Option ROMs are loaded depending on the boot device.   |
| Boot priority                           | Setting for prioritizing the boot option between UEFI and legacy boot.  | UEFI first                                     | Boots first from UEFI ROM.   |
|   |   | Legacy first                                   | Boots first from legacy ROM.   |
| EFI BS memory allocation                | Option for setting the memory for the EFI boot services.  | Disabled                                       | The minimum memory required for EFI boot services is reserved.   |
|   |   | Enabled  | The maximum memory required for EFI boot services (approx. 130 MB more) is reserved.                                     |

1) This setting is only possible if *Console redirection* is set to *Enabled*.

2) This setting is only possible if *Legacy boot* is set to *Enabled*.

## 7.1.9 Exit

| Phoenix SecureCore Technology Setup   |          |          |      |  |
|---|----------|----------|------|--|
| Main  | Advanced | Security | Boot | Exit   |
| Exit Saving Changes<br>Exit Discarding Changes<br>Load Setup Defaults<br>Discard Changes<br>Save Changes                      |          |          |      | <b>Item Specific Help</b><br><br>Equal to F10, save all changes of all menus, then exit setup configure driver. Finally resets the system automatically. |
| F1 Help ↕ Select Item +/- Change Values F9 Setup Defaults<br>ESC Exit ↔ Select Menu Enter Select > Sub-Menu F10 Save and Exit |          |          |      |  |

| BIOS setting            | Explanation  | Configuration options | Effect |
|-------------------------|--|-----------------------|--------|
| Exit saving changes     | Selecting this option closes BIOS Setup. Selecting this option saves any changes made to CMOS after confirmation.                        | Yes/No                |        |
| Exit discarding changes | Selecting this option closes BIOS Setup without saving any changes made.   | Yes/No                |        |
| Load setup defaults     | Selecting this option restores the BIOS default values.  | Yes/No                |        |
| Discard changes         | Selecting this option resets any settings that may have been made but forgotten in the meantime (provided they have not yet been saved). | Yes/No                |        |
| Save changes            | Selecting this option saves any changes made to CMOS after confirmation.   | Yes/No                |        |

## 7.1.10 Allocation of resources

### 7.1.10.1 RAM address assignment

| Address in hexadecimal | Size         | Resource                        |
|------------------------|--------------|---------------------------------|
| 00000000 to 0009FFFF   | 640 kB       | DOS (real mode) memory          |
| 000A0000 to 000BFFFF   | 128 kB       | Video memory                    |
| 000C0000 to 000CBFFF   | 48 kB        | VGA BIOS                        |
| 000CC000 to 000DFFFF   | 80 kB        | Option ROM or XMS               |
| 000E0000 to 000FFFFFF  | 64 kB        | System BIOS shadow RAM          |
| 00100000 to 7FFFFFFF   | 2 GB to 1 MB | System memory (low DRAM)        |
| 80000000 to FFF00000   | 2 GB to 1 MB | PCI low MMIO                    |
| FEC00000 to FEC00040   | 64 bytes     | IO APIC                         |
| FED00000 to FED003FF   | 1 kB         | HPET (timer)                    |
| FED01000 to FED1CFFF   | 112 kB       | Chipset internal register space |
| FEE00000 to FEFFFFFF   | 2 MB         | Local APIC                      |
| 100000000 to 17FFFFFFF | 2 GB         | System memory (high DRAM)       |
| 180000000 to F00000000 | 58 GB        | High MMIO                       |

### 7.1.10.2 I/O address assignments

| I/O address   | Resource                    |
|---------------|-----------------------------|
| 0000h - 00FFh | Motherboard resources       |
| 02E8h - 02EFh | COM D (optional)            |
| 02F8h - 02FFh | COM B (optional)            |
| 0384h - 0385h | CAN controller (optional)   |
| 03B0h - 03DFh | Video system                |
| 03E8h - 03EFh | COM C (optional)            |
| 03F8h - 03FFh | COM A (optional)            |
| 0400h - 04FFh | Motherboard resources       |
| 0500h - 0G1Fh | Motherboard resources       |
| 0CF8h - 0CFBh | PCI config address register |
| 0CFCh - 0CFFh | PCI config data register    |
| 0D00h - FFFFh | PCI / PCI Express bus       |
| 4100h - 41FFh | MTCX                        |

### 7.1.10.3 Interrupt assignments in PIC mode

| IRQ                  | 0                   | 1 | 2 | 3 | 4 | 5 | 6 | 7 | 8 | 9 | 10 | 11 | 12 | 13 | 14 | 15 | NONE |
|----------------------|---------------------|---|---|---|---|---|---|---|---|---|----|----|----|----|----|----|------|
| System timer         | •                   |   |   |   |   |   |   |   |   |   |    |    |    |    |    |    |      |
| Keyboard             |                     | • |   |   |   |   |   |   |   |   |    |    |    |    |    |    |      |
| IRQ cascade          |                     |   | • |   |   |   |   |   |   |   |    |    |    |    |    |    |      |
| ACPI <sup>1)</sup>   |                     |   |   |   |   |   |   |   |   | • |    |    |    |    |    |    |      |
| Real-time clock      |                     |   |   |   |   |   |   |   | • |   |    |    |    |    |    |    |      |
| Co-processor (FPU)   |                     |   |   |   |   |   |   |   |   |   |    |    |    | •  |    |    |      |
| B&R<br>Option-<br>al | COM B <sup>2)</sup> |   |   | • | ○ | ○ | ○ | ○ |   |   | ○  | ○  | ○  |    |    |    |      |
|                      | COM C <sup>3)</sup> |   |   |   | ○ | ○ | ○ | ○ |   |   | ○  | •  | ○  |    |    |    |      |
|                      | COM A <sup>4)</sup> |   |   |   | ○ | • | ○ | ○ |   |   | ○  | ○  | ○  |    |    |    |      |
|                      | COM D <sup>5)</sup> |   |   |   | ○ | ○ | ○ | ○ |   |   | •  | ○  | ○  |    |    |    |      |
|                      | CAN                 |   |   |   | ○ | ○ | ○ | ○ |   |   | •  | ○  | ○  |    |    |    |      |

- 1) Advanced Configuration and Power Interface
- 2) Resistive onboard touchscreen for Panel PC 2100
- 3) Monitor/Panel option, SDL/DVI transmitter, SDL3 transmitter
- 4) 5ACCIF01.FPLS-000 IF option, 5ACCIF01.FPLS-001, COM A.
- 5) IF option

- ... Default setting
- ... Optional setting

### 7.1.10.4 Interrupt assignments in APIC mode

A total of 23 IRQs are available in APIC (**A**dvanced **P**rogrammable **I**nterrupt **C**ontroller) mode. Enabling this option is only effective if done before the Windows operating system is installed.

| IRQ                   | 0                   | 1 | 2 | 3 | 4 | 5 | 6 | 7 | 8 | 9 | 10 | 11 | 12 | 13 | 14 | 15 | 16 | 17 | 18 | 19 | 20 | 21 | 22 | 23 | NONE |
|-----------------------|---------------------|---|---|---|---|---|---|---|---|---|----|----|----|----|----|----|----|----|----|----|----|----|----|----|------|
| System timer          | •                   |   |   |   |   |   |   |   |   |   |    |    |    |    |    |    |    |    |    |    |    |    |    |    |      |
| Keyboard              |                     | • |   |   |   |   |   |   |   |   |    |    |    |    |    |    |    |    |    |    |    |    |    |    |      |
| IRQ cascade           |                     |   | • |   |   |   |   |   |   |   |    |    |    |    |    |    |    |    |    |    |    |    |    |    |      |
| ACPI <sup>1)</sup>    |                     |   |   |   |   |   |   |   |   | • |    |    |    |    |    |    |    |    |    |    |    |    |    |    |      |
| Real-time clock       |                     |   |   |   |   |   |   |   | • |   |    |    |    |    |    |    |    |    |    |    |    |    |    |    |      |
| Co-processor (FPU)    |                     |   |   |   |   |   |   |   |   |   |    |    |    | •  |    |    |    |    |    |    |    |    |    |    |      |
| B&R<br>Option-<br>al  | COM B <sup>2)</sup> |   |   | • | ○ | ○ | ○ | ○ |   |   | ○  | ○  | ○  |    |    |    |    |    |    |    |    |    |    |    |      |
|                       | COM C <sup>3)</sup> |   |   |   | ○ | ○ | ○ | ○ |   |   | ○  | •  | ○  |    |    |    |    |    |    |    |    |    |    |    |      |
|                       | COM A <sup>4)</sup> |   |   |   | ○ | • | ○ | ○ | ○ |   |    | ○  | ○  | ○  |    |    |    |    |    |    |    |    |    |    |      |
|                       | COM D <sup>5)</sup> |   |   |   | ○ | ○ | ○ | ○ | ○ |   | •  | ○  | ○  |    |    |    |    |    |    |    |    |    |    |    |      |
|                       | CAN                 |   |   |   | ○ | ○ | ○ | ○ | ○ |   | •  | ○  | ○  |    |    |    |    |    |    |    |    |    |    |    |      |
| PIRQ A <sup>6)</sup>  |                     |   |   |   |   |   |   |   |   |   |    |    |    |    |    |    | •  |    |    |    |    |    |    |    |      |
| PIRQ B <sup>7)</sup>  |                     |   |   |   |   |   |   |   |   |   |    |    |    |    |    |    |    | •  |    |    |    |    |    |    |      |
| PIRQ C <sup>8)</sup>  |                     |   |   |   |   |   |   |   |   |   |    |    |    |    |    |    |    |    | •  |    |    |    |    |    |      |
| PIRQ D <sup>9)</sup>  |                     |   |   |   |   |   |   |   |   |   |    |    |    |    |    |    |    |    |    | •  |    |    |    |    |      |
| PIRQ E <sup>10)</sup> |                     |   |   |   |   |   |   |   |   |   |    |    |    |    |    |    |    |    |    |    | •  |    |    |    |      |
| PIRQ F <sup>11)</sup> |                     |   |   |   |   |   |   |   |   |   |    |    |    |    |    |    |    |    |    |    |    | •  |    |    |      |
| PIRQ G <sup>12)</sup> |                     |   |   |   |   |   |   |   |   |   |    |    |    |    |    |    |    |    |    |    |    |    | •  |    |      |
| PIRQ H <sup>13)</sup> |                     |   |   |   |   |   |   |   |   |   |    |    |    |    |    |    |    |    |    |    |    |    |    | •  |      |

- 1) Advanced Configuration and Power Interface
- 2) Resistive onboard touchscreen for Panel PC 2100
- 3) Monitor/Panel option, SDL/DVI transmitter, SDL3 transmitter
- 4) 5ACCIF01.FPLS-000 IF option, 5ACCIF01.FPLS-001, COM A.
- 5) IF option
- 6) PIRQ A: For PCIe; PCI Express root port 0, VGA, controller
- 7) PIRQ B: For PCIe; PCI Express root port 1, optional interface option.
- 8) PIRQ C: For PCIe; PCI Express root port 2, SMBus controller, ETH2 controller
- 9) PIRQ D: For PCIe; PCI Express root port 3, serial ATA controller, ETH1 controller
- 10) PIRQ E: XHCI host controller
- 11) PIRQ F: Unused
- 12) PIRQ G: Optional high definition audio controller
- 13) PIRQ H: EHCI host controller

- ... Default setting
- ... Optional setting

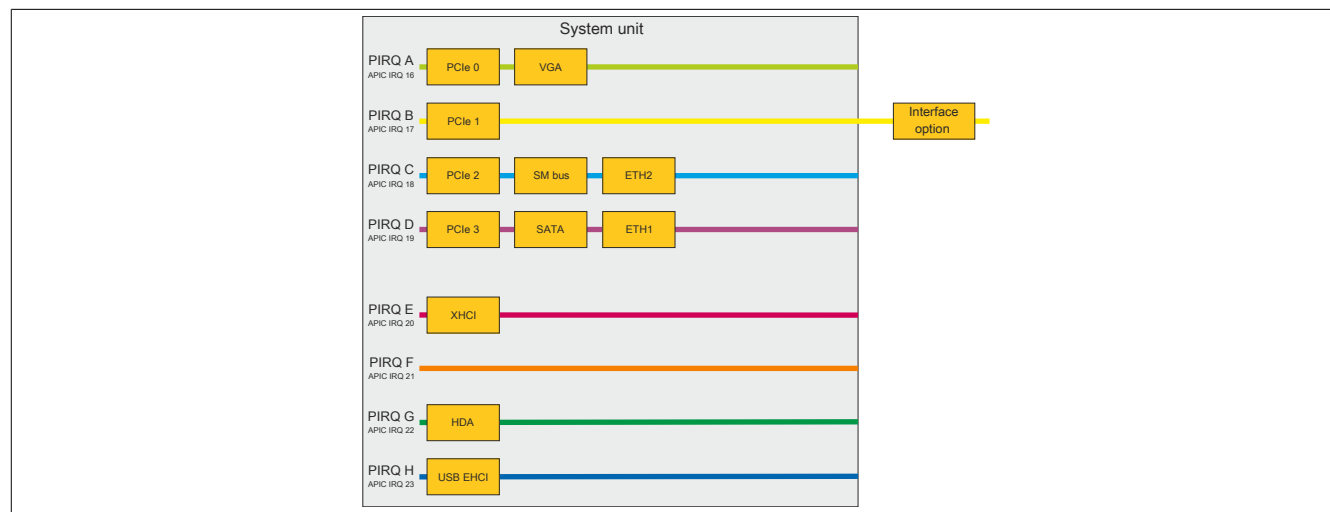

## 7.2 Upgrade information

### Warning!

The BIOS and firmware on B&R devices must always be kept up to date. New versions can be downloaded from the B&R website ([www.br-automation.com](http://www.br-automation.com)).

### 7.2.1 BIOS upgrade

An upgrade may be necessary for the following reason, for example:

- To update the functions implemented in BIOS Setup or to add newly implemented functions or components (for information about changes, see the readme file of the BIOS upgrade).

#### 7.2.1.1 Basic information

### Information:

During a BIOS upgrade, individually saved BIOS settings are deleted.

It is helpful to determine the different software versions before starting the upgrade.

#### 7.2.1.1.1 Which BIOS version and firmware are already installed?

This information is listed on the following BIOS Setup page.

- After switching on the PC, press "F2" to access BIOS Setup.
- Select "OEM features" from BIOS main menu "Advanced".

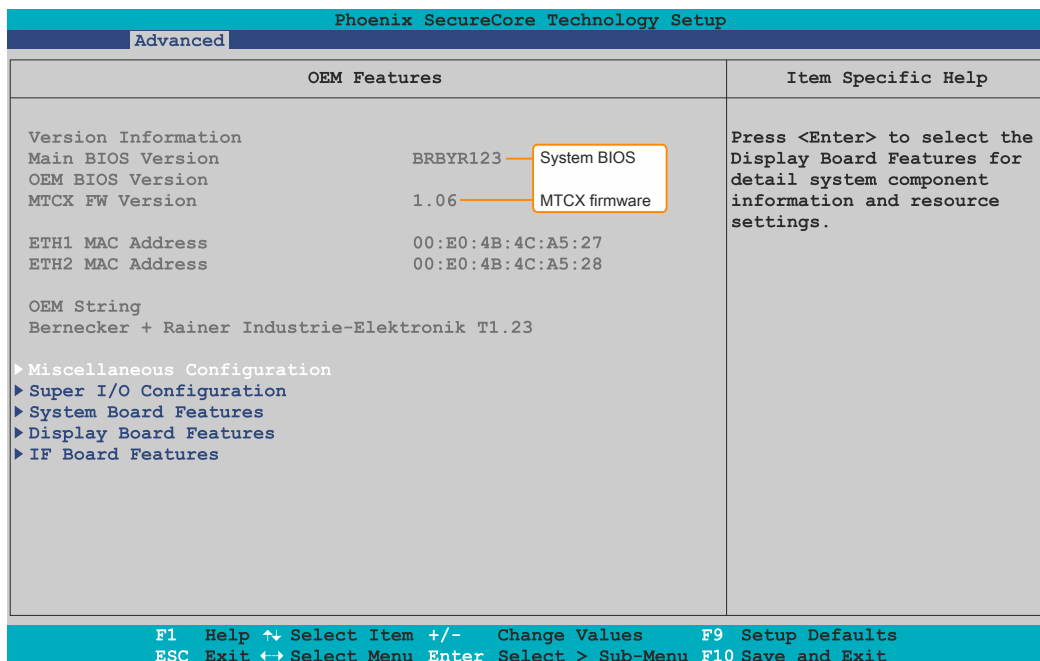

### 7.2.1.2 Procedure in the EFI shell

#### **Caution!**

**The PC is not permitted to be switched off or reset while performing an upgrade!**

1. Download the ZIP file from the B&R website ([www.br-automation.com](http://www.br-automation.com)).
2. Unzip the ZIP file and copy the files to a USB flash drive formatted in FAT16 or FAT32. Alternatively, a CFast card can also be used.
3. Reboot the PC and select "Internal shell" as the boot device ("F5" key to open the boot menu).
4. After booting the EFI shell, "startup.nsh" is executed and the BIOS upgrade is started.
5. After a successful upgrade, the system must be rebooted.
6. Reboot and press key "F2" to enter BIOS Setup and load the setup defaults; then select "Save changes and exit".

## 7.2.2 Upgrading the firmware on the Panel PC 2100

With "Firmware upgrade (MTCX)", it is possible to update the firmware depending on the version of the PPC2100 system.

A current firmware upgrade can be downloaded directly from the Downloads section of the B&R website ([www.br-automation.com](http://www.br-automation.com)).

### Caution!

**The PC is not permitted to be switched off or reset while performing an upgrade!**

### 7.2.2.1 Procedure in Windows (ADI Control Center)

1. Download the ZIP file from the B&R website ([www.br-automation.com](http://www.br-automation.com)).
  2. Open the *ADI Control Center* in the Control Panel.
  3. Open tab **Versions**.
  4. Click on the desired update under **PC firmware** or **Panel firmware**. The dialog box opens.
  5. Enter the name of the firmware file or select a file under "Filename".
  6. Execute file with **Open**.
  7. After a successful upgrade, the system must be switched off and on again for the upgrade to take effect.
- ✓ The upgrade is installed and in effect.

The transfer can be canceled by clicking on **Cancel** in dialog box "Download". This is disabled while writing to flash memory.

Erasing the data in flash memory can take several seconds depending on the memory module used. During this time, the progress indicator is not updated.

### Information:

**For more detailed information about saving and updating the firmware, see the ADI driver user's manual. This is available for download at [www.br-automation.com](http://www.br-automation.com).**

### 7.2.2.2 Procedure in the EFI shell

1. Download the ZIP file from the B&R website ([www.br-automation.com](http://www.br-automation.com)).
2. Unzip the ZIP file and copy the files to a USB flash drive formatted in FAT16 or FAT32. Alternatively, a CFast card can also be used.
3. Reboot the PC and select "Internal shell" as the boot device ("F5" key to open the boot menu).
4. After booting the EFI shell, "startup.nsh" is executed and the MTCX upgrade is started.
5. After a successful upgrade, a the system must be switched off and on again.

### Warning!

**Pressing panel keys during firmware transfer is not permitted! This can interfere with the process.**

### Information:

**The power supply to the PC must be switched off and on again for the new firmware to take effect and the updated version to be displayed.**

### 7.2.2.3 Firmware upgrade with Automation Runtime

The MTCX firmware is part of Automation Studio. The system is automatically updated to this status by Automation Runtime.

To update the firmware contained in Automation Studio, a hardware upgrade must be performed (see **Project management / Workspace / Upgrades** in Automation Help).

## 7.3 Multi-touch drivers

Multi-touch panels are approved as human-interface devices (i.e. multi-touch support from the operating system) for the following operating systems:

- Windows 10 IoT Enterprise 2016 LTSC
- Windows 10 IoT Enterprise 2015 LTSC
- Windows Embedded 8.1 Industry Pro
- Windows 7 Professional/Ultimate
- Windows Embedded Standard 7 Premium
- Linux for B&R 9
- Linux for B&R 8

No guarantee can be given for multi-touch or single-touch operation, compatibility and functionality for operation with other operating systems and/or individual touch screen drivers.

## 7.4 Windows 10 IoT Enterprise 2016 LTSB

### 7.4.1 General information

#### Information:

**Discontinuation of support for Windows 10 IoT Enterprise 2016 LTSB by Microsoft:**

**Security updates, hotfixes, free or paid support and technical resources will no longer be offered after October 13, 2026.**

Windows 10 IoT Enterprise 2016 LTSB is a version of Windows 10 Enterprise specifically developed for use in industrial applications (Long-Term Servicing Branch).

#### Information:

**For detailed information, see the user's manual of the operating system. This is available for download on the B&R website ([www.br-automation.com](http://www.br-automation.com)).**

### 7.4.2 PPC2100 - Order data

| Order number    | Short description  | Figure  |
|-----------------|--|---|
|                 | <b>Windows 10 IoT Enterprise 2016 LTSB</b>   |  |
| 5SWW10.0543-MUL | Windows 10 IoT Enterprise 2016 LTSB - 64-bit - Entry - Multilingual - PPC2100 chipset Bay Trail - CPU E3826/E3827/E3845 - License - Only available with a new device |   |
|                 | <b>Optional accessories</b>  |   |
|                 | <b>Windows 10 IoT Enterprise 2016 LTSB</b>   |   |
| 5SWW10.0800-MUL | Windows 10 IoT Enterprise 2016 LTSB - 64-bit - Language Pack DVD   |   |

### 7.4.3 PPC2100 - Overview

| Order number                        | 5SWW10.0543-MUL           |
|-------------------------------------|---------------------------|
| <b>Operating system</b>             |                           |
| Target systems                      |                           |
| Industrial PC                       | PPC2100                   |
| Processor                           | E3826/E3827/E3845         |
| Chipset                             | Bay Trail                 |
| Edition                             | Entry                     |
| Architecture                        | 64-bit (legacy BIOS boot) |
| Language                            | Multilingual              |
| Minimum size of RAM                 | 2 GB <sup>1)</sup>        |
| Minimum size of data storage medium | 20 GB <sup>2)</sup>       |

1) The specified memory size is a minimum requirement according to Microsoft. B&R recommends using 4 GB RAM or more for 64-bit operating systems.

2) The specified minimum size of the data storage medium does not take into account the memory requirements of additional language packages.

### 7.4.4 Features

The feature list shows the most important device functions in Windows 10 IoT Enterprise 2016 LTSB.

| Function                                       | Windows 10 IoT Enterprise 2016 LTSB                                   |
|--|---|
| Range of functions in Windows 10 Enterprise    | ✓   |
| Internet Explorer 11 including Enterprise Mode | ✓   |
| Multi-touch support                            | ✓   |
| Multilingual support                           | Can be installed via Language Pack DVDs (default language is English) |
| Page file                                      | Configurable (disabled by default in the image by the UWF)            |
| Hibernate file                                 | Configurable (disabled by default in the image)                       |
| System restore                                 | Configurable (disabled by default in the image by the UWF)            |
| SuperFetch                                     | Configurable (disabled by default in the image by the UWF)            |
| File indexing service                          | Configurable (disabled by default in the image by the UWF)            |
| Fast boot                                      | Configurable (disabled by default in the image by the UWF)            |
| Defragmentation service                        | ✓ (Disabled when enabling the UWF)                                    |
| <b>Additional embedded lockdown functions</b>  |   |
| Assigned access                                | Configurable  |
| AppLocker                                      | Configurable  |
| Shell Launcher                                 | Configurable  |
| Unified Write Filter                           | ✓   |
| Keyboard Filter                                | Configurable  |

## 7.4.5 Installation

Windows 10 IoT Enterprise 2016 LTSC is preinstalled by B&R on a suitable data storage medium (64-bit: at least 20 GB). After the system is switched on for the first time, it runs through the out-of-box experience (OOBE), which allows different settings to be made (e.g. language, region, keyboard, computer name, username).

Windows 10 IoT Enterprise 2016 LTSC is installed on the APC2100 and PPC2100 in BIOS mode.

## 7.4.6 Drivers

The operating system contains all drivers necessary for operation. If an older driver version is installed, the current version can be downloaded and installed from the B&R website ([www.br-automation.com](http://www.br-automation.com)). It is important to ensure that "Unified Write Filter (UWF)" is disabled.

### Information:

**Necessary drivers must be downloaded from the B&R website, not from manufacturer websites.**

## 7.4.7 Activation

Windows 10 IoT Enterprise 2016 LTSC must be activated like its predecessor Windows 10 IoT Enterprise 2015 LTSC. This takes place at B&R.

The activation status can be checked in the Control Panel (symbolic image):

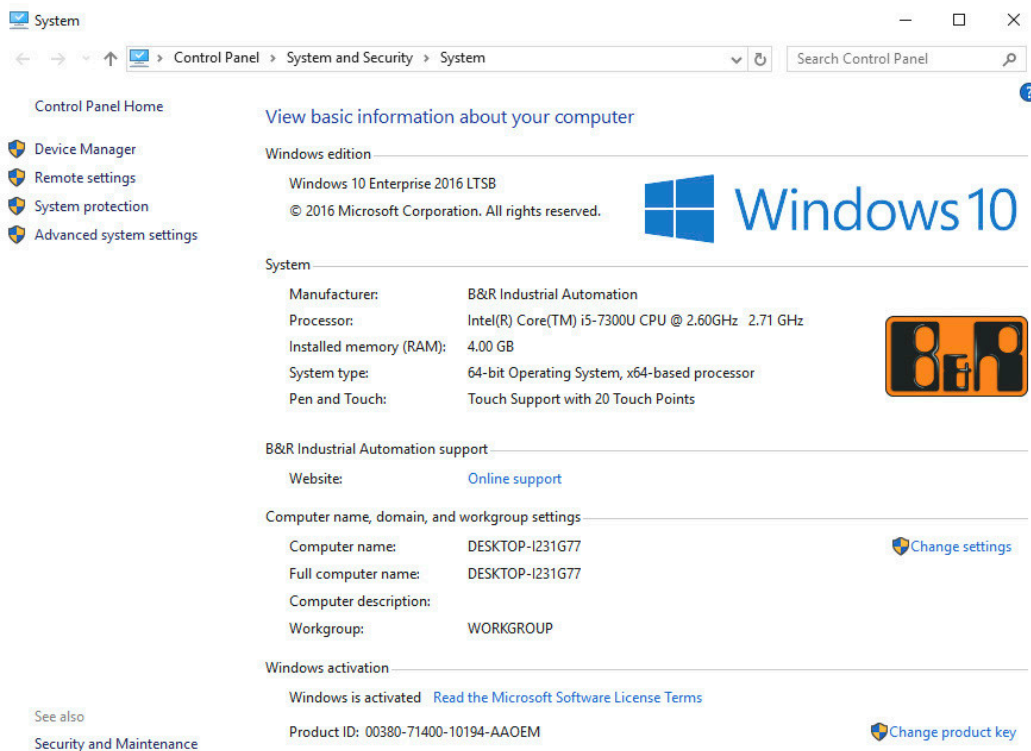

Activation carried out by B&R is supported by special B&R extensions in the operating system and theoretically not lost when the hardware is changed (e.g. replacement of components in the event of repair) or when the system is reinstalled, unlike Windows 10 IoT Enterprise 2015 LTSC (Microsoft reserves the right to make technical changes without notice).

### Information:

**It is not required to enter a product key for activation.**

## 7.4.8 Characteristics, limitations

- Unlike standard Windows 10 Enterprise, Windows 10 IoT Enterprise 2016 LTSC does not include Cortana, the Microsoft Edge browser or the Microsoft Store, for example.
- The LTSC version is based on build 14393 of Windows 10 and does not receive any feature updates.

The version installed by B&R contains optimized settings for operation in an industrial environment. These are described in detail in a manual for Windows 10 IoT Enterprise 2016 LTSB. This can be downloaded at no cost from the Downloads section of the B&R website ([www.br-automation.com](http://www.br-automation.com)) (login required).

**Information:**

**These settings as well as the features not included in the LTSB version cause different behavior compared to a standard Windows 10 Enterprise installation.**

#### **7.4.9 Supported display resolutions**

Per Microsoft requirements, Windows 10 IoT Enterprise 2016 LTSB requires SVGA resolution (800 x 600) or higher to enable full operation of the Windows user interface (including system dialog boxes, apps, etc.). A lower resolution can be selected for applications.

## 7.5 Windows 10 IoT Enterprise 2015 LTSB

### 7.5.1 General information

#### Information:

**Discontinuation of support for Windows 10 IoT Enterprise 2015 LTSB by Microsoft:**

**Security updates, hotfixes, free or paid support and technical resources will no longer be offered after October 14, 2025.**

Windows 10 IoT Enterprise 2015 LTSB is the successor to Windows Embedded 8.1 Industry and based on new Windows 10 technology. The operating system also offers a higher level of protection for industrial applications through additional lockdown functions. Windows 10 IoT Enterprise 2015 LTSB is a special version of Windows 10 Enterprise for industrial use (Long Term Servicing Branch).

#### Information:

**For detailed information, see the user's manual of the operating system. This is available for download on the B&R website ([www.br-automation.com](http://www.br-automation.com)).**

### 7.5.2 PPC2100 - Order data

| Order number    | Short description   | Figure  |
|-----------------|---|---|
|                 | <b>Windows 10 IoT Enterprise 2015 LTSB</b>  |  |
| 5SWW10.0243-MUL | Windows 10 IoT Enterprise 2015 LTSB - 64-bit - Multilingual - PPC2100 chipset Bay Trail - License (without Recovery DVD) - Only available with a new device |   |
|                 | <b>Optional accessories</b>   |   |
|                 | <b>Windows 10 IoT Enterprise 2015 LTSB</b>  |   |
| 5SWW10.0200-MUL | Windows 10 IoT Enterprise 2015 LTSB - 64-bit - Multilingual - Recovery DVD  |   |
| 5SWW10.0400-MUL | Windows 10 IoT Enterprise 2015 LTSB - 64-bit - Language Pack DVD  |   |

### 7.5.3 Overview

| Order number                        | 5SWW10.0243-MUL     |
|-------------------------------------|---------------------|
| <b>Operating system</b>             |                     |
| Target systems                      |                     |
| Industrial PC                       | PPC2100             |
| Processor                           | No limitation       |
| Chipset                             | Bay Trail           |
| Edition                             | Embedded            |
| Architecture                        | 64-bit              |
| Language                            | Multilingual        |
| Minimum size of RAM                 | 2 GB <sup>1)</sup>  |
| Minimum size of data storage medium | 20 GB <sup>2)</sup> |

- 1) The specified memory size is a minimum requirement according to Microsoft. B&R recommends using at least 4 GB RAM with 64-bit operating systems, however.
- 2) The specified minimum size of the data storage medium does not take into account the memory requirements of additional language packages.

### 7.5.4 Features

The feature list shows the most important device functions in Windows 10 IoT Enterprise 2015 LTSB.

| Function  | Windows 10 IoT Enterprise 2015 LTSB                                   |
|---|---|
| Range of functions of Windows 10 Enterprise 2015 LTSB | ✓   |
| Internet Explorer 11 including Enterprise Mode        | ✓   |
| Multi-touch support                                   | ✓   |
| Multilingual support                                  | Can be installed via Language Pack DVDs (default language is English) |
| Page file   | Configurable (disabled by default in the image by the UWF)            |
| Hibernate file  | Configurable (disabled by default in the image)                       |
| System restore  | Configurable (disabled by default in the image by the UWF)            |
| SuperFetch  | Configurable (disabled by default in the image by the UWF)            |
| File indexing service                                 | Configurable (disabled by default in the image by the UWF)            |
| Fast boot   | Configurable (disabled by default in the image by the UWF)            |
| Defragmentation service                               | Configurable (disabled by default in the image by the UWF)            |
| <b>Additional embedded lockdown functions</b>         |   |

| Function             | Windows 10 IoT Enterprise 2015 LTSB |
|----------------------|-------------------------------------|
| Assigned access      | Configurable                        |
| AppLocker            | Configurable                        |
| Shell Launcher       | Configurable                        |
| Unified Write Filter | ✓                                   |

## 7.5.5 Installation

Windows 10 IoT Enterprise 2015 LTSB is preinstalled by B&R on a suitable data storage medium (64-bit: at least 20 GB). After the system has been switched on for the first time, it runs through the out-of-box experience (OOBE), which allows different settings to be made (e.g. language, region, keyboard, computer name, username).

## 7.5.6 Drivers

The operating system contains all drivers necessary for operation. If an older driver version is installed, the current version can be downloaded and installed from the B&R website ([www.br-automation.com](http://www.br-automation.com)). It is important to ensure that "Unified Write Filter (UWF)" is disabled.

### Information:

**Necessary drivers must be downloaded from the B&R website, not from manufacturer websites.**

## 7.5.7 Activation

Windows 10 IoT Enterprise 2015 LTSB must be activated like its predecessor Windows Embedded 8.1 Industry Pro. This takes place at B&R.

The activation status can be checked in the Control Panel (symbolic image):

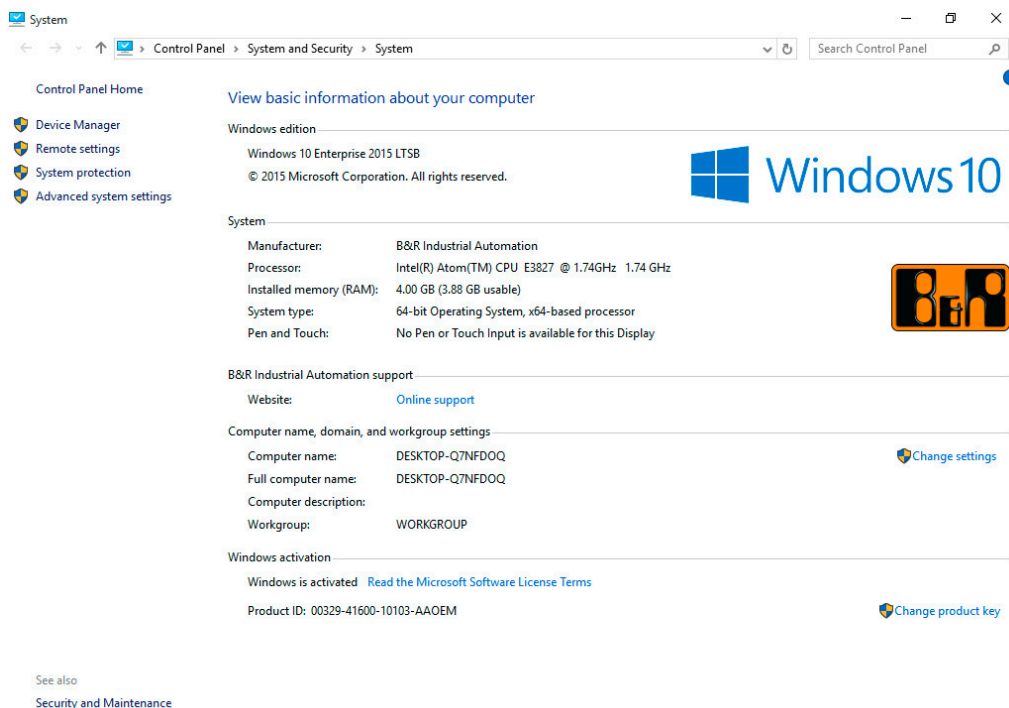

### Information:

**Activation may be lost if the hardware is changed (e.g. replacement of components in the event of repairs) or if the system is reinstalled (e.g. with the recovery DVD).**

In this case, a message is displayed on the screen that is always visible (watermark):

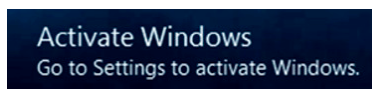

Windows 10 IoT Enterprise 2015 LTSB does not carry out any restarts or show any pop-up messages, which means that it is fully functional at all times. "Personalization" is not possible, however (e.g. setting the desktop background image).

The product can be activated at a later time either over the phone or via the Internet. For corresponding instructions, see "Update & Security > Activation" in the Windows Control Panel.

### **Information:**

**Entering a product key is not required for a new activation in any case.**

## **7.5.8 Content of delivery of the recovery DVD**

The DVD with the order number 5SWW10.0200-MUL is for recovery purposes only.

### **Information:**

**This only performs the basic installation of a Windows 10 Enterprise 2015 LTSB. In contrast to the preinstalled operating system versions, the operating system does not include device-specific drivers (network, graphics, ADI, etc.) or optimized settings, nor is it activated! The product can be activated at a later time either over the phone or via the Internet (see "[Activation](#)").**

## **7.5.9 Characteristics, limitations**

- Unlike standard Windows 10 Enterprise, Windows 10 IoT Enterprise 2015 LTSB does not include Cortana, the Microsoft Edge browser or the Microsoft Store, for example.
- The LTSB version is based on build 10240 of Windows 10 and does not receive any feature updates.

The version installed by B&R contains optimized settings for operation in an industrial environment. These are described in detail in the "Windows 10 IoT 2015 LTSB working guide". This can be downloaded at no cost from the Downloads section of the B&R website ([www.br-automation.com](http://www.br-automation.com)) (login required).

### **Information:**

**These settings as well as the features not included in the LTSB version cause different behavior compared to a standard Windows 10 Enterprise installation.**

## **7.5.10 Supported display resolutions**

Per Microsoft requirements, Windows 10 IoT Enterprise 2015 LTSB requires SVGA resolution (800 x 600) or higher to enable full operation of the Windows user interface (including system dialog boxes, apps, etc.). A lower resolution can be selected for applications.

## 7.6 Windows Embedded 8.1 Industry Pro

### 7.6.1 General information

#### Information:

**Discontinuation of support for Windows Embedded 8.1 Industry Professional by Microsoft:**

**Security updates, hotfixes, free or paid support and technical resources will no longer be offered after July 11, 2023.**

Windows Embedded 8.1 Industry Pro is an operating system specially tailored to industrial applications. It is based on the new Windows 8.1 technology and contains additional lockdown functions to make industrial PCs more secure. The system is based on the complete Windows 8.1 Pro operating system and therefore offers full compatibility for applications and drivers.

### 7.6.2 Order data

| Order number    | Short description   | Figure  |
|-----------------|---|---|
|                 | <b>Windows Embedded 8.1 Industry Pro</b>  |  |
| 5SWWI8.0343-MUL | Windows Embedded 8.1 Industry Pro - 32-bit - Multilingual - For the PPC2100 - License |   |
| 5SWWI8.0443-MUL | Windows Embedded 8.1 Industry Pro - 64-bit - Multilingual - For the PPC2100 - License |   |
|                 | <b>Optional accessories</b>   |   |
|                 | <b>Windows Embedded 8.1 Industry Pro</b>  |   |
| 5SWWI8.0100-MUL | Windows Embedded 8.1 Industry Professional - 32-bit - Recovery DVD                    |   |
| 5SWWI8.0200-MUL | Windows Embedded 8.1 Industry Professional - 64-bit - Recovery DVD                    |   |
| 5SWWI8.0500-MUL | Windows Embedded 8.1 Industry Professional - 32-bit - Language Pack DVD               |   |
| 5SWWI8.0600-MUL | Windows Embedded 8.1 Industry Professional - 64-bit - Language Pack DVD               |   |

### 7.6.3 Overview

| Order number                        | 5SWWI8.0343-MUL     | 5SWWI8.0443-MUL     |
|-------------------------------------|---------------------|---------------------|
| <b>Operating system</b>             |                     |                     |
| Target systems                      |                     |                     |
| Industrial PC                       |                     | PPC2100             |
| Chipset                             |                     | Bay Trail           |
| Edition                             |                     | Embedded            |
| Architecture                        | 32-bit              | 64-bit              |
| Language                            |                     | Multilingual        |
| Minimum size of RAM                 | 1 GB <sup>1)</sup>  | 2 GB <sup>2)</sup>  |
| Minimum size of data storage medium | 16 GB <sup>3)</sup> | 20 GB <sup>3)</sup> |

- 1) If UWF (Unified Write Filter) is enabled, 2 GB RAM are recommended. The specified memory size is a minimum requirement according to Microsoft. B&R recommends using at least 2 GB RAM with 32-bit operating systems, however.
- 2) The specified memory size is a minimum requirement according to Microsoft. B&R recommends using at least 4 GB RAM with 64-bit operating systems, however.
- 3) The specified minimum size of the data storage medium does not take into account the memory requirements of additional language packages.

### 7.6.4 Features

The feature list shows the most important device functions in Windows Embedded 8.1 Industry Pro.

| Function                                       | Windows Embedded 8.1 Industry Pro                                     |
|--|---|
| Range of functions in Windows 8.1 Pro          | ✓   |
| Internet Explorer 11 including Enterprise Mode | ✓   |
| Multi-touch support                            | ✓   |
| Multilingual support                           | Can be installed via Language Pack DVDs (default language is English) |
| Page file                                      | Configurable (disabled by default in the image by the UWF)            |
| Hibernate file                                 | Configurable (disabled by default in the image)                       |
| System restore                                 | Configurable (disabled by default in the image by the UWF)            |
| SuperFetch                                     | Configurable (disabled by default in the image by the UWF)            |
| File indexing service                          | Configurable (disabled by default in the image by the UWF)            |
| Fast boot                                      | Configurable (disabled by default in the image by the UWF)            |
| Defragmentation service                        | Configurable (disabled by default in the image by the UWF)            |
| <b>Additional embedded lockdown functions</b>  |   |
| Assigned access                                | Configurable  |
| Dialog box filter                              | Configurable  |

| Function                       | Windows Embedded 8.1 Industry Pro |
|--------------------------------|-----------------------------------|
| Embedded lockdown manager      | ✓                                 |
| Keyboard Filter                | Configurable                      |
| Shell Launcher                 | Configurable                      |
| Toast notification filter      | Configurable                      |
| USB filter                     | Configurable                      |
| Unified Write Filter           | ✓                                 |
| Windows 8 application launcher | Configurable                      |
| Gesture filter                 | Configurable                      |

### 7.6.5 Installation

Windows Embedded 8.1 Industry Pro is preinstalled by B&R on a suitable data storage medium (32-bit: at least 16 GB, 64-bit: at least 20 GB). After the system is switched on for the first time, it runs through the out-of-box experience (OOBE), which allows different settings to be made (e.g. language, region, keyboard, computer name, username).

#### Information:

If entering the product key is required during the OOBE, this can be skipped by entering "SKIP".

### 7.6.6 Drivers

The operating system contains all drivers necessary for operation. If an older driver version is installed, the latest version can be downloaded and installed from the B&R website ([www.br-automation.com](http://www.br-automation.com)). It is only important to ensure that "Unified Write Filter (UWF)" is disabled.

#### Information:

Necessary drivers must be downloaded from the B&R website, not from manufacturer websites.

### 7.6.7 Activation

Windows Embedded 8.1 Industry Pro must be activated in contrast to the previous versions Windows 7 and Windows XP Pro. This takes place at B&R.

The activation status can be checked in the Control Panel:

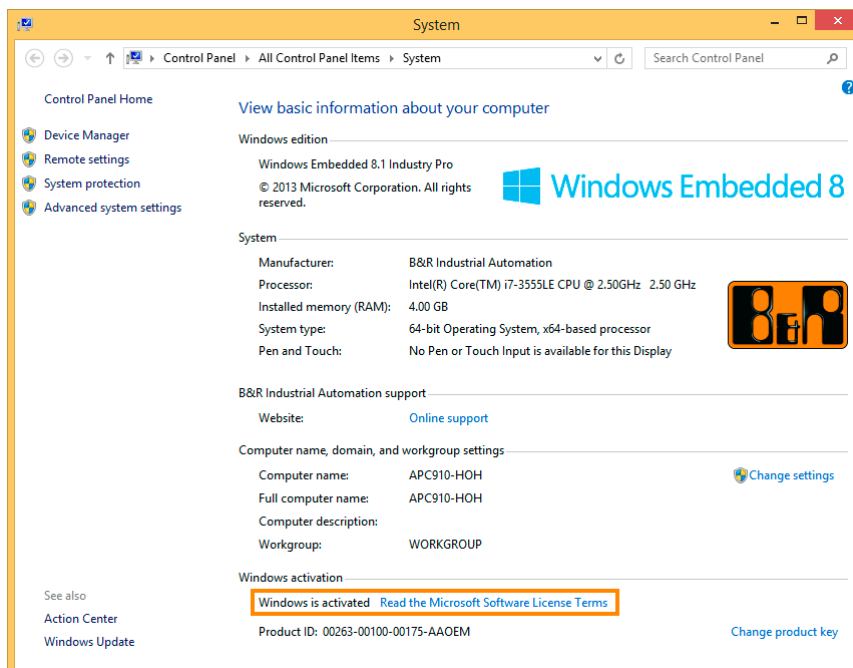

#### Information:

Activation may be lost if the hardware is changed (e.g. if components are replaced in case of repair) or if the system is reinstalled (e.g. with the recovery DVD).

In this case, a "watermark message" will always be shown on the screen:

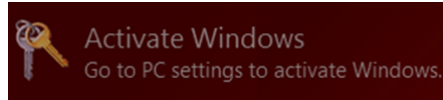

Windows Embedded 8.1 Industry Pro does not carry out any restarts or show any pop-up messages, which means that it is fully functional at all times. Only "personalizations" (e.g. setting the desktop background image) cannot be carried out.

The product can be activated at a later time either over the phone or via the Internet. Instructions are available on the Microsoft website.

Activation via direct Internet connection:

[http://msdn.microsoft.com/en-us/library/dn449258\(v=winembedded.82\).aspx](http://msdn.microsoft.com/en-us/library/dn449258(v=winembedded.82).aspx)

Activation by telephone:

[http://msdn.microsoft.com/en-us/library/dn449379\(v=winembedded.82\).aspx](http://msdn.microsoft.com/en-us/library/dn449379(v=winembedded.82).aspx)

## Information:

**Entering a product key is not required for a new activation in any case.**

### 7.6.8 Content of delivery of the recovery DVD.

DVDs with order numbers 5SWWI8.0100-MUL and 5SWWI8.0200-MUL are only for recovery purposes.

## Information:

**This only performs the basic installation of a Windows Embedded 8.1 Industry Pro. In contrast to the preinstalled operating system versions, the operating system does not include device-specific drivers (network, graphics, ADI, etc.) or optimized settings, nor is it activated! The product can be activated at a later time either over the phone or via the Internet (see "Activation").**

### 7.6.9 Lockdown features

The lockdown functions in Windows Embedded 8.1 Industry Pro make it possible to individually configure the device while making the system more secure at the same time. Among other things, they include:

- Unified Write Filter (UWF):  
This allows a data storage medium (e.g. CFast card) to be configured for read-only access, for example, and only certain registry keys can be accessed. As a result, the system always starts with the same configuration after rebooting.
- Dialog box filter:  
This can be used to suppress pop-up windows and dialog boxes. Such dialog boxes can occur, for example, if virus scanners are updated, network connections fail or the Windows Security Center shows warnings. These dialog boxes are simply hidden.
- Keyboard Filter:  
This allows individual keys or key combinations to be locked, e.g. so that the user cannot access the Task Manager.

For further information about the lockdown functions, see the Microsoft website:

[http://msdn.microsoft.com/en-us/library/dn449278\(v=winembedded.82\).aspx](http://msdn.microsoft.com/en-us/library/dn449278(v=winembedded.82).aspx)

### 7.6.10 Supported display resolutions

Per Microsoft requirements, Windows Embedded 8.1 Industry Pro requires XGA resolution (1024 x 768) or higher to enable full operation of the Windows user interface (including system dialog boxes, apps, etc.). A lower resolution can be selected for applications.

## 7.7 Windows 7

### 7.7.1 General information

#### Information:

##### Discontinuation of support for Windows 7 by Microsoft:

After January 14, 2020, Microsoft will no longer be providing any security updates, hotfixes, support (free or paid) or technical resources for Windows 7.

Windows 7 offers a variety of innovative features and performance enhancements. The 64-bit variants make full use of the current PC infrastructure. Faster switching to sleep mode, quicker restores, less memory usage and high-speed detection of USB devices are just a few of the advantages provided by Windows 7. Both English and German are available in Windows 7 Professional, while Windows 7 Ultimate supports up to 35 different languages (up to 36 languages in Service Pack 1). Product activation is not required for use on B&R PCs, which is a great advantage for simple logistical processes in the area of machine automation.

All Windows operating systems offered by B&R are from the Microsoft Embedded division. This means considerably longer availability compared to the consumer market.

### 7.7.2 Order data

| Order number    | Short description                                    | Figure  |
|-----------------|--|---|
|                 | <b>Windows 7 Professional/Ultimate</b>               |  |
| 5SWWI7.1100-GER | Windows 7 Professional SP1 - 32-bit - German - DVD   |   |
| 5SWWI7.1100-ENG | Windows 7 Professional SP1 - 32-bit - English - DVD  |   |
| 5SWWI7.1200-GER | Windows 7 Professional SP1 - 64-bit - German - DVD   |   |
| 5SWWI7.1200-ENG | Windows 7 Professional SP1 - 64-bit - English - DVD  |   |
| 5SWWI7.1300-MUL | Windows 7 Ultimate SP1 - 32-bit - Multilingual - DVD |   |
| 5SWWI7.1400-MUL | Windows 7 Ultimate SP1 - 64-bit - Multilingual - DVD |   |

### 7.7.3 Overview

| Order number                                  | 5SWWI7.1100-GER   | 5SWWI7.1100-ENG | 5SWWI7.1200-GER   | 5SWWI7.1200-ENG | 5SWWI7.1300-MUL   | 5SWWI7.1400-MUL   |
|---|---|-----------------|---|-----------------|---|---|
| <b>Operating system</b>                       |   |                 |   |                 |   |   |
| Target systems                                |   |                 |   |                 |   |   |
| Industrial PC                                 | APC510<br>APC511<br>APC810<br>APC910<br>APC2100<br>PPC800<br>PPC900<br>PPC2100<br>PP500 |                 | APC810<br>APC910<br>APC2100<br>PPC800<br>PPC900<br>PPC2100    |                 | APC510<br>APC511<br>APC810<br>APC910<br>APC2100<br>PPC800<br>PPC900<br>PPC2100<br>PP500 | APC810<br>APC910<br>APC2100<br>PPC800<br>PPC900<br>PPC2100        |
| Chipset                                       | 945GME<br>GM45<br>QM77/HM76<br>NM10<br>US15W<br>Bay Trail                               |                 | 945GME<br>GM45<br>QM77/HM76<br>QM170/HM170/CM236<br>Bay Trail |                 | 945GME<br>GM45<br>QM77/HM76<br>NM10<br>US15W<br>Bay Trail                               | 945GME<br>GM45<br>QM77/HM76<br>QM170/<br>HM170/CM236<br>Bay Trail |
| Edition                                       | Professional  |                 |   |                 | Ultimate  |   |
| Architecture                                  | 32-bit  |                 | 64-bit  |                 | 32-bit  | 64-bit  |
| Service pack                                  | SP1   |                 |   |                 |   |   |
| Language                                      | German  | English         | German  | English         | Multilingual  |   |
| Minimum size of RAM                           | 1 GB <sup>1)</sup>  |                 | 2 GB <sup>2)</sup>  |                 | 1 GB <sup>1)</sup>  | 2 GB <sup>2)</sup>  |
| Required storage space on data storage medium | 16 GB   |                 | 20 GB   |                 | 16 GB <sup>3)</sup>   | 20 GB <sup>3)</sup>   |

- 1) The specified memory size is a minimum requirement according to Microsoft. B&R recommends using at least 2 GB RAM with 32-bit operating systems, however.
- 2) The specified memory size is a minimum requirement according to Microsoft. B&R recommends using at least 4 GB RAM with 64-bit operating systems, however.
- 3) The memory space required by additional language packs is not taken into account in the minimum size for the data storage medium.

### 7.7.4 Installation

Windows 7 is preinstalled by B&R on the desired data storage medium (e.g. CFast card). All necessary drivers (graphics, network, etc.) for operation are also installed.

### 7.7.5 Drivers

Current drivers for all approved operating systems are available for download in the Downloads section of the B&R website ([www.br-automation.com](http://www.br-automation.com)).

#### **Information:**

**Necessary drivers must be downloaded from the B&R website, not from manufacturer websites.**

### 7.7.6 Characteristics, limitations

- Beep.sys no longer exists in Windows 7; therefore, an acoustic signal (e.g. when a button is pressed) can no longer be heard.
- Determining the Windows 7 system assessment (system classification) is currently not supported (this does not apply to PP500, APC2100, APC510, APC511, APC910, PPC2100 and PPC800 with NM10 chipset).

#### **Information:**

**32-bit operating systems are not recommended for system units with 4 GB or more of main memory. For further information, see section "[Miscellaneous configuration](#)" on page 210 under "PCI MMIO size".**

### 7.7.7 Supported display resolutions

Per Microsoft requirements, Windows 7 requires XGA resolution (1024 x 768) or higher to enable full operation of the Windows user interface (including system dialog boxes, etc.). A lower resolution can be selected for applications.

## 7.8 Windows Embedded Standard 7

### 7.8.1 General information

#### Information:

##### Discontinuation of support for Windows Embedded Standard 7 by Microsoft:

**After October 13, 2020, Microsoft will no longer be providing any security updates, hotfixes, support (free or paid) or technical resources for Windows Embedded Standard 7.**

The successor variant to Windows XP Embedded is Windows Embedded Standard 7. As with previous versions, the embedded operating system offers full system support for B&R industrial PCs. In addition to new features that are also included in Windows 7 Professional, Windows Embedded Standard 7 includes embedded components such as Enhanced Write Filter, File-Based Write Filter, Registry Filter and USB boot. Windows Embedded Standard 7 is available in two versions. The main difference is the ability to execute in multiple languages. Windows Embedded Standard 7 is only available in a single language, whereas Windows Embedded Standard 7 Premium supports the installation of several languages simultaneously.

With Windows Embedded Standard 7, Microsoft has made substantial improvements in the area of security. The AppLocker program, available in the premium variant, can prevent the execution of unknown or potentially undesired applications that are being installed over a network or from drives that are directly connected. A tiered approach allows the differentiation between scripts (.ps1, .bat, .cmd, .vbs and .js), installation files (.msi, .msp) and libraries (.dll, .ocx). AppLocker can also be configured to record undesired activity and display it in the Event Viewer. Windows Embedded Standard 7 is available in both 32-bit and 64-bit versions (64-bit versions are not supported by all systems). As a result, even demanding applications based on 64-bit technology are supported.

### 7.8.2 Order data

| Order number                       | Short description  | Figure  |
|------------------------------------|--|---|
| <b>Windows Embedded Standard 7</b> |  |   |
| 5SWWI7.1543-ENG                    | Windows Embedded Standard 7 SP1 - 32-bit - Service Pack 1 - English - PPC2100 - License (without Recovery DVD) - Only available with a new device              |  |
| 5SWWI7.1643-ENG                    | Windows Embedded Standard 7 SP1 - 64-bit - Service Pack 1 - English - PPC2100 - License (without Recovery DVD) - Only available with a new device              |   |
| 5SWWI7.1743-MUL                    | Windows Embedded Standard 7 Premium SP1 - 32-bit - Service Pack 1 - Multilingual - PPC2100 - License (without Recovery DVD) - Only available with a new device |   |
| 5SWWI7.1843-MUL                    | Windows Embedded Standard 7 Premium SP1 - 64-bit - Service Pack 1 - Multilingual - PPC2100 - License (without Recovery DVD) - Only available with a new device |   |
| <b>Optional accessories</b>        |  |   |
| <b>Windows Embedded Standard 7</b> |  |   |
| 5SWWI7.1900-MUL                    | Windows Embedded Standard 7 SP1 - 32-bit - Language Pack DVD   |   |
| 5SWWI7.2000-MUL                    | Windows Embedded Standard 7 SP1 - 64-bit - Language Pack DVD   |   |

### 7.8.3 Overview

| Order number                        | 5SWWI7.1543-ENG    | 5SWWI7.1643-ENG    | 5SWWI7.1743-MUL     | 5SWWI7.1843-MUL    |
|-------------------------------------|--------------------|--------------------|---------------------|--------------------|
| <b>Operating system</b>             |                    |                    |                     |                    |
| Target systems                      |                    |                    |                     |                    |
| Industrial PC                       | PPC2100            |                    |                     |                    |
| Chipset                             | Bay Trail          |                    |                     |                    |
| Edition                             | Embedded           |                    | Premium             |                    |
| Architecture                        | 32-bit             | 64-bit             | 32-bit              | 64-bit             |
| Service pack                        | SP1                |                    |                     |                    |
| Language                            | English            |                    | Multilingual        |                    |
| Minimum size of RAM                 | 1 GB <sup>1)</sup> | 2 GB <sup>2)</sup> | 1 GB <sup>1)</sup>  | 2 GB <sup>2)</sup> |
| Minimum size of data storage medium | 16 GB              |                    | 16 GB <sup>3)</sup> |                    |

- 1) The specified memory size is a minimum requirement according to Microsoft. B&R recommends using at least 2 GB RAM with 32-bit operating systems, however.
- 2) The specified memory size is a minimum requirement according to Microsoft. B&R recommends using at least 4 GB RAM with 64-bit operating systems, however.
- 3) The memory space required by additional language packs is not taken into account in the minimum size for the data storage medium.

### 7.8.4 Features

The feature list shows the most important device functions in Windows Embedded Standard 7.

| Function  | Windows Embedded Standard 7 | Windows Embedded Standard 7 Premium |
|---|-----------------------------|-------------------------------------|
| Enhanced Write Filter (EWF)                         | ✓                           | ✓                                   |
| File Based Write Filter (FBWF)                      | ✓                           | ✓                                   |
| Administrator account                               | ✓                           | ✓                                   |
| User account  | Configurable                | Configurable                        |
| Windows Explorer shell                              | ✓                           | ✓                                   |
| Registry filter                                     | ✓                           | ✓                                   |
| Internet Explorer 11.0                              | ✓                           | ✓                                   |
| Internet Information Service (IIS) 7.0              | ✓                           | ✓                                   |
| Anti-malware (Windows Defender)                     | -                           | ✓                                   |
| Add-ons (Snipping Tool, Sticky Notes)               | -                           | ✓                                   |
| Windows firewall                                    | ✓                           | ✓                                   |
| .NET Framework 3.5                                  | ✓                           | ✓                                   |
| 32-bit and 64-bit support                           | ✓                           | ✓                                   |
| Remote Desktop Protocol 7.0                         | ✓                           | ✓                                   |
| File compression utility                            | ✓                           | ✓                                   |
| Windows Installer service                           | ✓                           | ✓                                   |
| Windows XP mode                                     | -                           | -                                   |
| Media Player 12                                     | ✓                           | ✓                                   |
| DirectX   | ✓                           | ✓                                   |
| Multilingual user interface packs in the same image | -                           | ✓                                   |
| International components and language services      | ✓                           | ✓                                   |
| Language pack installer                             | ✓                           | ✓                                   |
| Windows Update                                      | Configurable                | Configurable                        |
| Windows PowerShell 2.0                              | ✓                           | ✓                                   |
| BitLocker   | -                           | ✓                                   |
| AppLocker   | -                           | ✓                                   |
| Tablet PC support                                   | -                           | ✓                                   |
| Multi-touch support                                 | -                           | ✓                                   |
| Boot from USB stick                                 | ✓                           | ✓                                   |
| Accessories   | ✓                           | ✓                                   |
| Page file   | Configurable                | Configurable                        |
| Number of fonts                                     | 134                         | 134                                 |

Table 94: Device functions in Windows Embedded Standard 7

## 7.8.5 Installation

Windows Embedded Standard 7 is preinstalled by B&R on a suitable CFast card (32-bit: at least 16 GB, 64-bit: at least 16 GB). After the system is switched on for the first time, it is configured automatically. This procedure takes approx. 30 minutes, and the device will be automatically rebooted a number of times.

### Information:

If the EWF (Enhanced Write Filter) should be used, all mass storage devices (except the boot drive) must be removed from the system during setup or SYSPREP. Alternatively, the additional mass storage devices can also be disabled in BIOS.

## 7.8.6 Drivers

The operating system contains all drivers necessary for operation. If an older driver version is installed, the most current version can be downloaded and installed from the B&R website ([www.br-automation.com](http://www.br-automation.com)). It is only important to ensure that "Enhanced Write Filter (EWF)" is disabled.

## 7.8.7 Characteristics, limitations

### Information:

32-bit operating systems are not recommended for system units with 4 GB or more of main memory. For further information, see section "Miscellaneous configuration" on page 210 under "PCI MMIO size".

## 7.8.8 Supported display resolutions

Per Microsoft requirements, Windows Embedded Standard 7 requires XGA resolution (1024 x 768) or higher to enable full operation of the Windows user interface (including system dialog boxes, etc.). A lower resolution can be selected for applications.

## 7.9 Automation Runtime

### 7.9.1 General information

The real-time operating system Automation Runtime is an integral part of Automation Studio. This real-time operating system forms the software core for running applications on a target system.

- Guarantees the highest possible performance of the hardware being used
- Runs on all B&R target systems
- Makes the application hardware-independent
- Easy portability of applications between B&R target systems
- Guaranteed determinism through cyclic system
- Configurable jitter tolerance in all task classes
- Support for all relevant programming languages, such as IEC 61131-3 languages and C
- Rich function library per IEC 61131-3 as well as the extended B&R automation library
- Integrated in Automation NET. Access to all networks and bus systems via function calls or by configuration in Automation Studio

B&R Automation Runtime is fully embedded in the corresponding target system (hardware on which Automation Runtime is installed). It thus enables application programs to access I/O systems (also via the fieldbus) and other devices such as interfaces and networks.

### 7.9.2 Order data

| Order number | Short description                               | Figure   |
|--------------|---|--|
|              | <b>Technology Guard</b>                         |  |
| 0TG1000.01   | Technology Guard (MSD)                          |  |
| 0TG1000.02   | Technology Guard (HID)                          |  |
| 1TG4600.10-5 | Automation Runtime Windows TG license           |  |
| 1TG4601.06-5 | Automation Runtime Embedded, TG license         |  |
| 1TG4601.06-T | Automation Runtime Embedded Terminal TG license |  |

### 7.9.3 Automation Runtime Windows (ARwin)

#### System requirements

The following software versions (or higher) are required to operate Automation Runtime Windows on a Panel PC 2100:

- ARwin upgrade AR C4.10
- ARwin upgrade AR N4.10 for 5PPC2100.BY48-000
- Automation Studio V4.1.4.0
- Technology Guard

#### Information:

**In order to operate Automation Runtime Windows (ARwin), BIOS setting *Advanced - Miscellaneous configuration - Realtime environment* must be set to *Enabled*.**

**Information:**

To slightly improve the real-time behavior (jitter) of Automation Runtime Windows (ARwin) with a graphics-heavy application, BIOS settings *Advanced - Graphics (IGD) configuration - IGD turbo* and *Advanced - Graphics (IGD) configuration - RC6 (render standby)*<sup>4)</sup> can be set to *Disabled*.

If the BIOS setting *Advanced - Graphics (IGD) Configuration - IGD Turbo* is set to *Disabled*, the graphics performance of the system is noticeably reduced.

**7.9.4 Automation Runtime Embedded (ARemb)****System requirements**

The following software versions (or higher) are required to operate Automation Runtime Embedded on a Panel PC 2100:

- ARemb upgrade AR C4.10
  - There is support with single-touch functionality starting with this version for 5AP933\* multi-touch panels with Rev. ≤ B7.
- ARemb upgrade AR F4.10
  - There is support with single-touch functionality starting with this version for 5AP933\* multi-touch panels with Rev. ≤ B7 and Rev. ≥ B8.
- ARemb upgrade AR M4.10
  - There is support with single-touch functionality starting with this version for 5AP1130\* multi-touch panels.
- ARemb upgrade AR N4.10 for 5PPC2100.BY48-000
- Automation Studio V4.1.4.0
- Visual Components Runtime (VC) V4.15.0
- Process Visualization Interface (PVI) V4.1.5
- Technology Guard

PVI Development Setup must be downloaded from the B&R website ([www.br-automation.com](http://www.br-automation.com)) and installed separately!

**Information:**

In order to operate Automation Runtime Embedded (ARemb), BIOS setting *Advanced - Miscellaneous configuration - Realtime environment* must be set to *Enabled*.

**Information:**

In order to slightly improve the real-time behavior (jitter) of Automation Runtime Embedded (ARemb) in graphics-intensive applications, set BIOS setting *Advanced - Graphics (IGD) configuration - IGD turbo* to *Disabled*.

**Important:** If BIOS setting *Advanced - Graphics (IGD) configuration - IGD turbo* is set to *Disabled*, the graphics performance of the system is noticeably reduced.

**7.9.5 Technology Guarding**

Technology Guarding is license protection used for individual software components. The "Technology Guard" (dongle) serves as the license container; this is connected to an available USB interface on the target system.

B&R Automation Runtime software components are subject to licensing. The use of the Technology Guard is mandatory if these components have not been selected as a software package.

**Information:**

**Licensing using the Technology Guarding wizard is available starting with Automation Studio V4.1 and Automation Runtime V4.08. A Technology Guard is not necessary in earlier Automation Runtime versions.**

For additional information about Technology Guarding, see Automation Help.

<sup>4)</sup> For BIOS versions 1.40 and later: *RC6 (render standby)* is automatically disabled when *Realtime environment* is enabled.

## 7.10 B&R Hypervisor

B&R Hypervisor allows multiple operating systems to operate simultaneously on a single device. The operating systems can communicate with each other via a virtual network.

### Intelligent distribution of CPU resources

B&R Hypervisor allows Windows or Linux to run simultaneously with Automation Runtime. This makes it possible to combine a controller and HMI PC in one device. With B&R Hypervisor, an industrial PC can also be used as an edge controller. This serves as a controller and simultaneously transmits pre-processed data to higher-level systems in the cloud via OPC UA.



### Virtual network

The hypervisor provides a virtual network connection that allows applications to exchange data between operating systems. Similar to an ordinary Ethernet interface, standard network protocols are used. In place of a cable, there is a reserved memory area that is not allocated to either operating system.

### Maximum flexibility

The user configures the hypervisor and allocates hardware resources in the B&R Automation Studio software development environment. The system configurations are determined individually. This makes the assignment of resources to the respective operating system flexible. Whereas previous simultaneous solutions were tailored to a specific Windows version, B&R Hypervisor is completely independent of the version of the operating systems used.

### System requirements

The following minimum software versions are required to operate B&R Hypervisor on the Panel PC 2100 :

- ARemb upgrade AR F4.44
- Automation Studio V4.4
- PPC2100 BIOS V1.40
- PPC2100 MTCX V1.13

### Information:

To operate B&R Hypervisor, settings *Advanced - Miscellaneous configuration - Realtime environment and Hypervisor environment* must be set to *Enabled*.

### Information:

For detailed information, see Automation Help or the B&R website ([www.br-automation.com](http://www.br-automation.com)).

## 7.11 mapp Technology

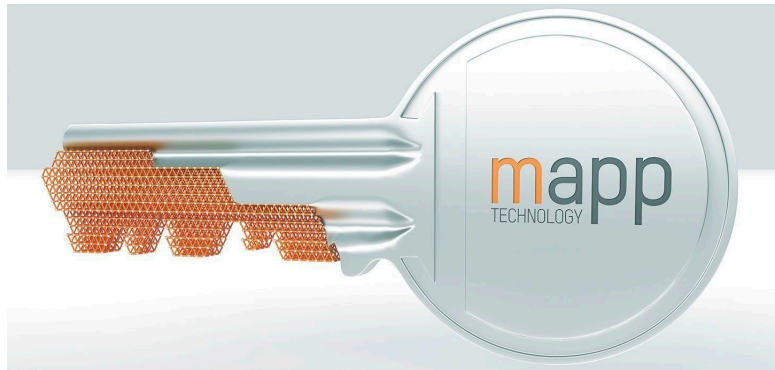

mapp Technology is revolutionizing the creation of machine and plant software. "mapps" are as easy to use as smartphone apps. Instead of programming user/role systems, alarm systems or the control of axes line by line, the machine software developer simply configures the finished mapps. Complex algorithms are easy to master. The programmer can concentrate fully on the machine process.

**Information:**

For detailed information, see Automation Help or the B&R website ([www.br-automation.com](http://www.br-automation.com)).

## 7.12 Linux for B&R 8 (GNU/Linux)

### 7.12.1 General information

#### Information:

**Security updates, hotfixes, free or paid support and technical resources will no longer be offered after June 30, 2020.**

Linux or GNU/Linux are usually free, UNIX-like multi-user operating systems based on the Linux kernel and fundamentally on GNU software. Wide (also commercial) distribution was made possible starting in 1992 by licensing the Linux kernel under the GPL.

The Linux version created by B&R is based on Debian 8. It already contains all the drivers required for the respective device and can therefore be used immediately without any additional effort.

Advantages of Debian:

- High stability
- Large package selection

For more information about Debian, see <http://www.debian.org>.

### 7.12.2 Order data

| Order number    | Short description   | Figure   |
|-----------------|---|--|
|                 | <b>Linux for B&amp;R 8</b>  |  |
| 5SWLIN.0543-MUL | Linux for B&R 8 - 32-bit - Multilingual - PPC2100 Bay Trail chipset - Installation - Only available with a new device |  |
| 5SWLIN.0643-MUL | Linux for B&R 8 - 64-bit - Multilingual - PPC2100 Bay Trail chipset - Installation - Only available with a new device |  |
|                 | <b>Optional accessories</b>   |  |
|                 | <b>CFast cards</b>  |  |
| 5CFAST.016G-00  | CFast 16 GB SLC   |  |
| 5CFAST.032G-00  | CFast 32 GB SLC   |  |
| 5CFAST.032G-10  | CFast 32 GB MLC   |  |
| 5CFAST.064G-10  | CFast 64 GB MLC   |  |
| 5CFAST.128G-10  | CFast 128 GB MLC  |  |
| 5CFAST.4096-00  | CFast 4 GB SLC  |  |
| 5CFAST.8192-00  | CFast 8 GB SLC  |  |

### 7.12.3 Overview

| Order number                        | 5SWLIN.0543-MUL | 5SWLIN.0643-MUL |
|-------------------------------------|-----------------|-----------------|
| <b>Operating system</b>             |                 |                 |
| Target systems                      |                 |                 |
| Industrial PC                       |                 | PPC2100         |
| Chipset                             |                 | Bay Trail       |
| Architecture                        | 32-bit          | 64-bit          |
| Language                            |                 | Multilingual    |
| Minimum size of RAM                 |                 | 1 GB            |
| Minimum size of data storage medium |                 | 4 GB            |

### 7.12.4 Features

- LXDE desktop
- Touch screen driver
- MTCX driver
- ADI library
- HMI diagnostics tool
- Tool for right-click support via touch screen
- Virtual keyboard

Detailed instructions about Linux for B&R 8 can be downloaded from the Downloads section of the B&R website ([www.br-automation.com](http://www.br-automation.com)).

### 7.12.5 Installation

Linux for B&R 8 is preinstalled by B&R on the desired data storage medium (e.g. CFast card). All necessary drivers (graphics, network, etc.) for operation are also installed.

Debian 8 can also be downloaded from the Debian website (<http://www.debian.org>) and installed separately. Instructions are also available on the Debian website.

Notes regarding special features of installation on B&R devices are described in a separate document that can be downloaded from the B&R website ([www.br-automation.com](http://www.br-automation.com)).

Installation packages are available for the necessary B&R adjustments; these can also be downloaded from the B&R website ([www.br-automation.com](http://www.br-automation.com)).

### 7.12.6 Drivers

The operating system contains all drivers necessary for operation.

The current version of B&R-specific drivers can be downloaded and installed from the B&R website ([www.br-automation.com](http://www.br-automation.com)).

## 7.13 Linux for B&R 9 (GNU/Linux)

### 7.13.1 General information

#### Information:

Security updates, hotfixes, free or paid support and technical resources will no longer be offered after June 30, 2022.

Reasons for Debian:

- High stability
- Large package selection
- Wide distribution of Debian and various derivatives (e.g. Ubuntu, Linux Mint)

For additional information, see the Debian website (<https://www.debian.org/>).

#### Information:

For detailed information, see the user's manual of the operating system. This is available for download on the B&R website ([www.br-automation.com](http://www.br-automation.com)).

### 7.13.2 Order data

| Order number    | Short description   | Figure   |
|-----------------|---|--|
|                 | <b>Linux for B&amp;R 9</b>  |  |
| 5SWLIN.0743-MUL | Linux for B&R 9 - 64-bit - Multilingual - PPC2100 Bay Trail chipset - Installation - Only available with a new device |  |
|                 | <b>Optional accessories</b>   |  |
|                 | <b>CFAST cards</b>  |  |
| 5CFAST.016G-00  | CFAST 16 GB SLC   |  |
| 5CFAST.032G-00  | CFAST 32 GB SLC   |  |
| 5CFAST.032G-10  | CFAST 32 GB MLC   |  |
| 5CFAST.064G-10  | CFAST 64 GB MLC   |  |
| 5CFAST.128G-10  | CFAST 128 GB MLC  |  |
| 5CFAST.256G-10  | CFAST 256 GB MLC  |  |
| 5CFAST.4096-00  | CFAST 4 GB SLC  |  |
| 5CFAST.8192-00  | CFAST 8 GB SLC  |  |

### 7.13.3 Overview

| Order number                        | 5SWLIN.0743-MUL |
|-------------------------------------|-----------------|
| <b>Operating system</b>             |                 |
| Target systems                      |                 |
| Industrial PC                       | PPC2100         |
| Chipset                             | Bay Trail       |
| Architecture                        | 64-bit          |
| Language                            | Multilingual    |
| Minimum size of RAM                 | 1 GB            |
| Minimum size of data storage medium | 4 GB            |

### 7.13.4 Features

- LXDE desktop
- Touch screen support
- MTCX driver
- ADI library
- Tool for right-click support via touch screen
- Virtual keyboard

Detailed instructions about Linux for B&R 9 can be downloaded from the Downloads section of the B&R website ([www.br-automation.com](http://www.br-automation.com)).

### 7.13.5 Installation

Linux for B&R 9 is preinstalled on the desired data storage medium (e.g. CFAST card).

### 7.13.6 Drivers

Current drivers for all approved operating systems are available for download in the Downloads section of the B&R website ([www.br-automation.com](http://www.br-automation.com)).

**Information:**

Necessary drivers must be downloaded from the B&R website, not from manufacturer websites.

## 7.14 ADI Control Center

The settings of B&R devices can be read out and changed in Windows using the ADI Control Center in the Control Panel. The figure shown is a symbolic image; the representation may vary depending on the device.

### Information:

The displayed temperature and voltage values (e.g. CPU temperature, core voltage, battery voltage) represent uncalibrated information values. No conclusions about possible alarms or hardware malfunctions can be drawn from this. The hardware components used have automatic diagnostic functions in the event of error.

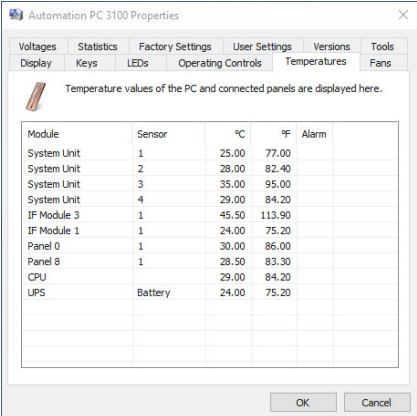

Temperature values of the PC and connected panels are displayed here.

| Module      | Sensor  | °C    | °F     | Alarm |
|-------------|---------|-------|--------|-------|
| System Unit | 1       | 25.00 | 77.00  |       |
| System Unit | 2       | 28.00 | 82.40  |       |
| System Unit | 3       | 35.00 | 95.00  |       |
| System Unit | 4       | 29.00 | 84.20  |       |
| IF Module 3 | 1       | 45.50 | 113.90 |       |
| IF Module 1 | 1       | 24.00 | 75.20  |       |
| Panel 0     | 1       | 30.00 | 86.00  |       |
| Panel 8     | 1       | 28.50 | 83.30  |       |
| CPU         |         | 29.00 | 84.20  |       |
| UPS         | Battery | 24.00 | 75.20  |       |

### 7.14.1 Functions

The ADI Control Center offers the following functions, for example:

- Changing display-specific parameters
- Reading out device-specific keys
- Updating the key configuration
- Testing keys or device-specific LEDs of a membrane keypad
- Reading out or calibrating control devices (e.g. key switch, handwheel, joystick, potentiometer)
- Reading out temperatures, fan speeds, switch positions and statistical data
- Reading out operating hours (power-on hours)
- Reading user settings and factory settings
- Reading out software versions
- Updating and backing up BIOS and firmware
- Creating reports for the current system (support)
- Setting the SDL equalizer value for the SDL cable adjustment
- Changing the user serial ID

For a detailed description, see the user documentation for the ADI driver.

### Information:

The functions available in the ADI Control Center depend on the device family.

### 7.14.2 Installation

The ADI driver is included in most B&R Windows operating systems or can be installed on request.

The ADI driver (also includes the ADI Control Center) and user documentation can be downloaded at no cost from the Downloads section of the B&R website ([www.br-automation.com](http://www.br-automation.com)). If a more recent version is available, it can be installed later.

### Information:

The *Write filter* must be disabled during installation.

## 7.15 ADI Development Kit

This software allows *ADI* functions to be accessed from Windows applications created with Microsoft Visual Studio, for example:

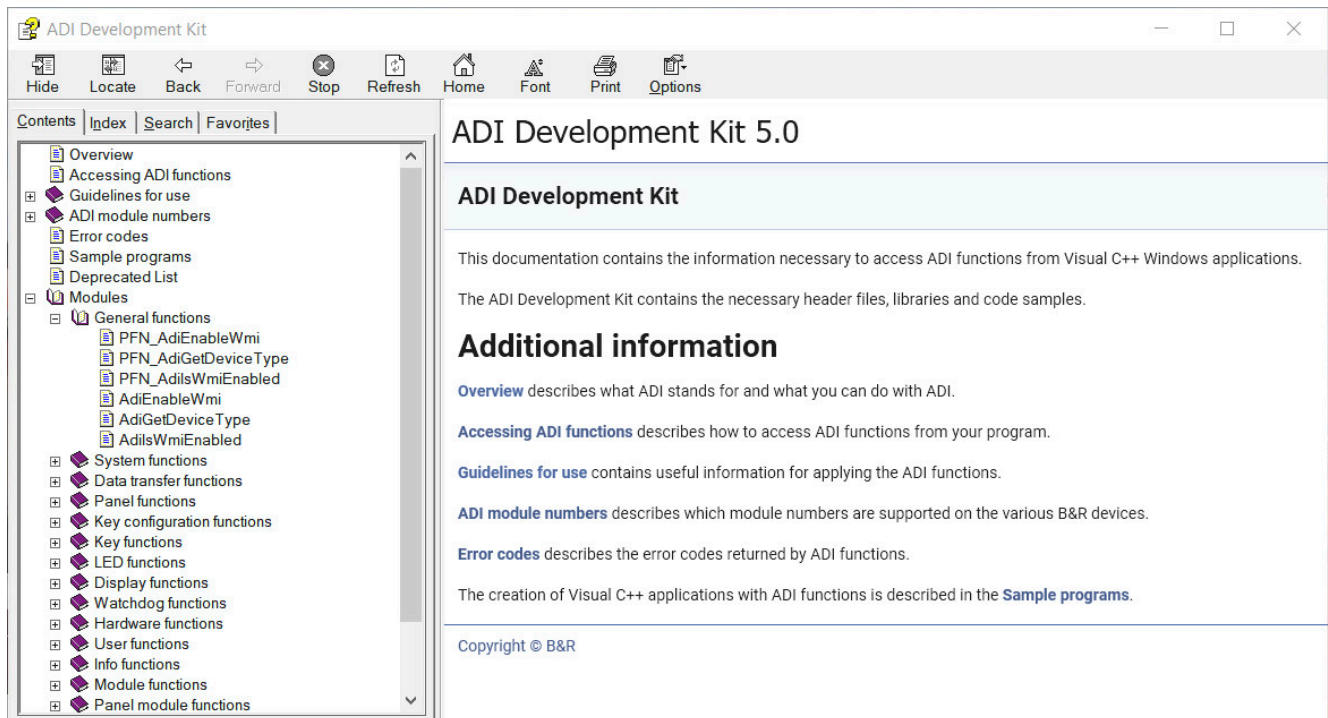

### Features:

- Header files and import libraries
- Help files
- Example projects
- ADI DLL: For testing applications if no ADI driver is installed.

The appropriate ADI driver must be installed for the device. The ADI driver is already included in B&R images of embedded operating systems.

For a detailed description of how to use ADI functions, see Automation Help.

The ADI Development Kit can be downloaded at no cost from the Downloads section of the B&R website ([www.br-automation.com](http://www.br-automation.com)).

## 7.16 ADI .NET SDK

This software allows *ADI* functions to be accessed from .NET applications created with Microsoft Visual Studio.

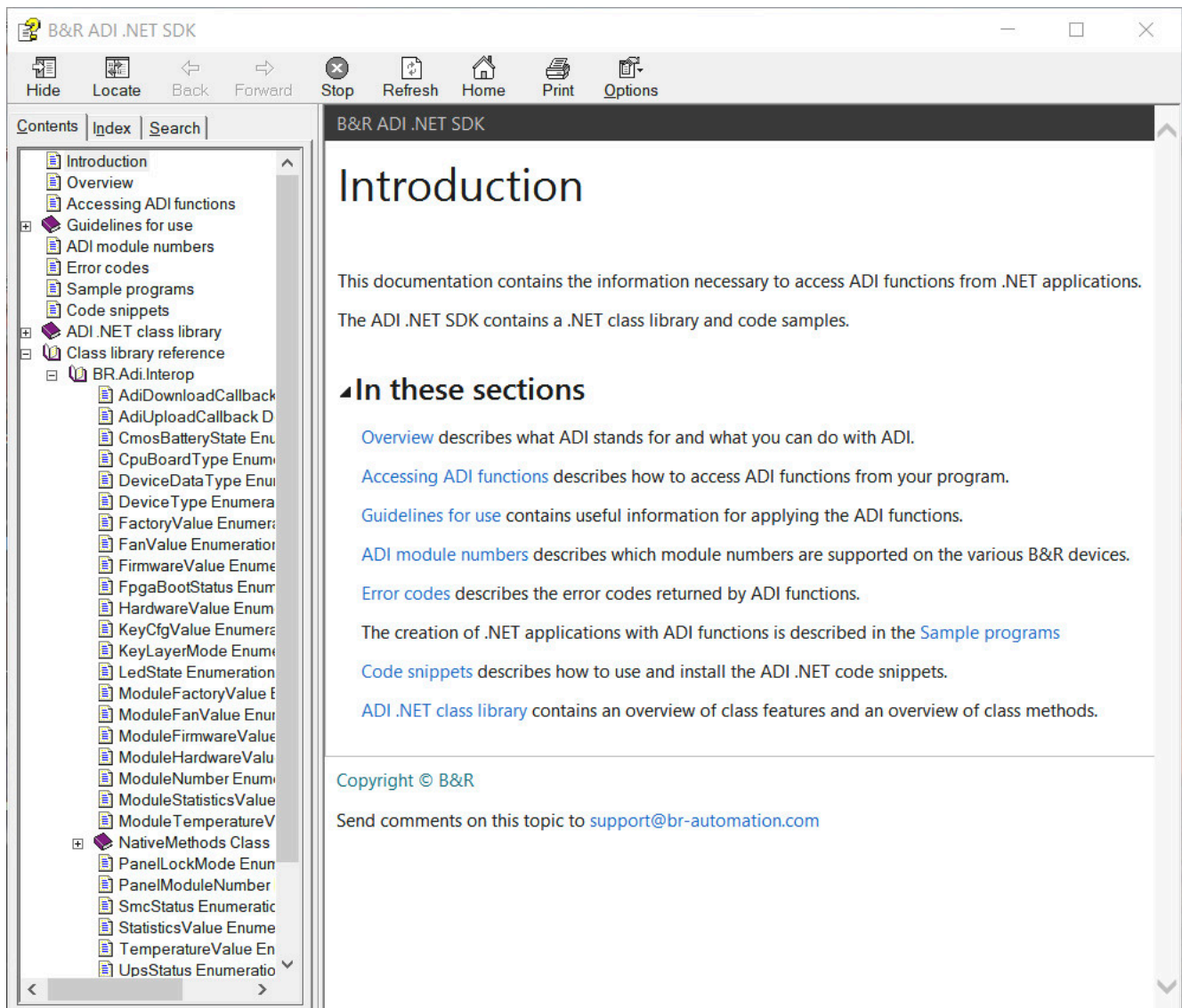

### Features:

- ADI .NET class library
- Help files (in English)
- Sample projects and code snippets
- ADI DLL: For testing applications if no ADI driver is installed.

The appropriate ADI driver must be installed for the device. The ADI driver is already included in B&R images of embedded operating systems.

For a detailed description of how to use ADI functions, see Automation Help.

The ADI .NET SDK can be downloaded at no cost from the Downloads section of the B&R website ([www.br-automation.com](http://www.br-automation.com)).

## 7.17 Key Editor

A frequently occurring requirement for panels is adapting function keys and LEDs to the application software. With the Key Editor, individual adaptation to the application is possible quickly and easily.

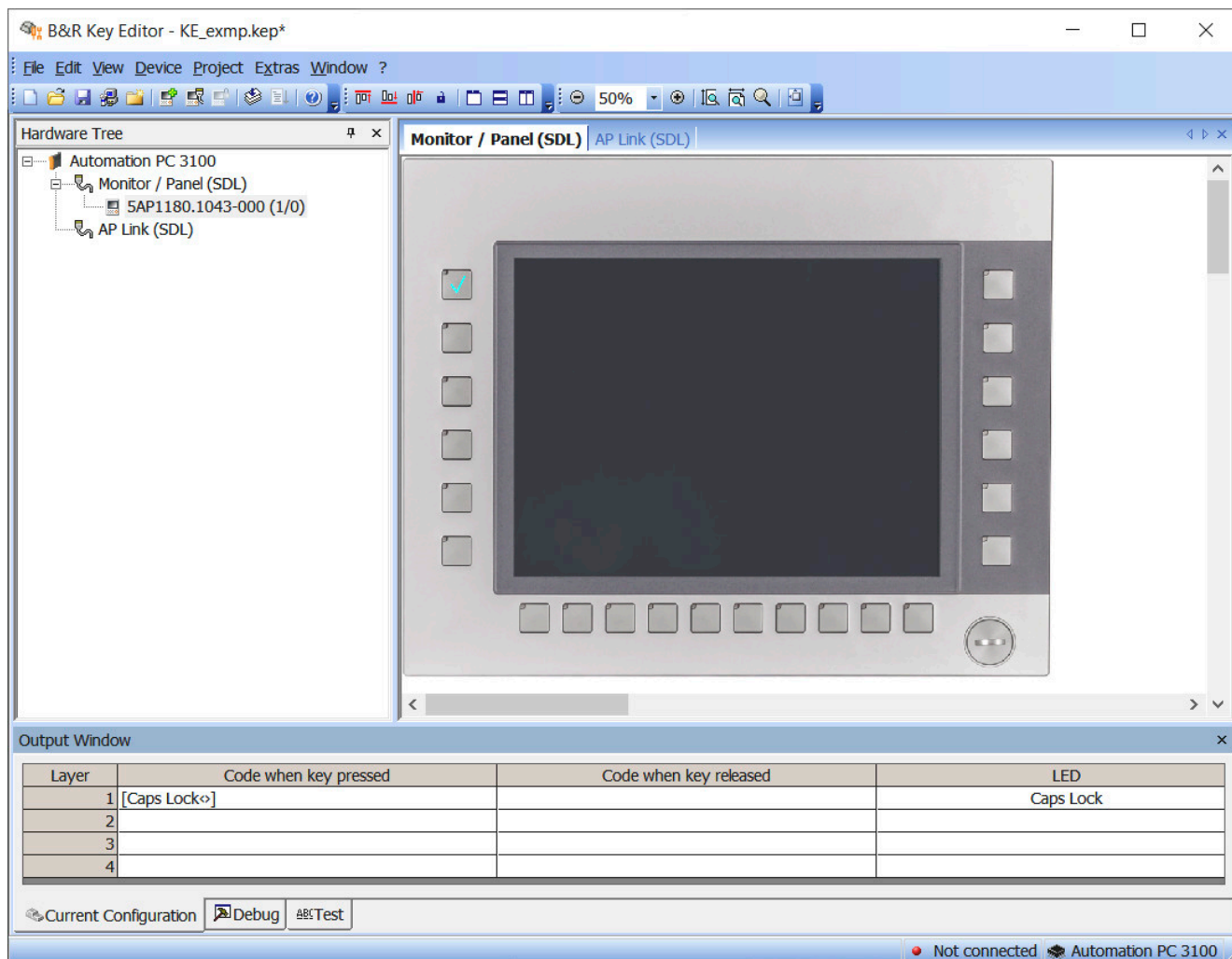

### Features:

- Configuration of normal keys like on a keyboard (A, B, C, etc.)
- Keyboard shortcuts (CTRL+C, SHIFT+DEL, etc.) on one key
- Special key functions (change brightness, etc.)
- Assignment of LED functions (HDD access, power, etc.)
- 4 assignments possible per key (using layers)
- Configuration of the panel lock time when connecting several Automation Panel devices to Automation PCs and Panel PCs

For detailed instructions about configuring keys and LEDs and installing the key configuration on the target system, see the help documentation for the Key Editor. The Key Editor and help documentation can be downloaded at no cost from the Downloads section of the B&R website ([www.br-automation.com](http://www.br-automation.com)).

## 7.18 KCF Editor

The KCF Editor can be used as a simple alternative to the Key Editor. It can also be used to adapt function keys and LEDs to the application software. In contrast to the Key Editor, operation does not take place using a graphical representation of the device, but via a simple Windows dialog box. The KCF Editor can therefore also be used for devices that are not yet supported in the Key Editor. The KCF Editor is a "portable" application and can be started directly from a USB flash drive without installation on the target device, for example.

An installed ADI driver is required for the full range of functions.

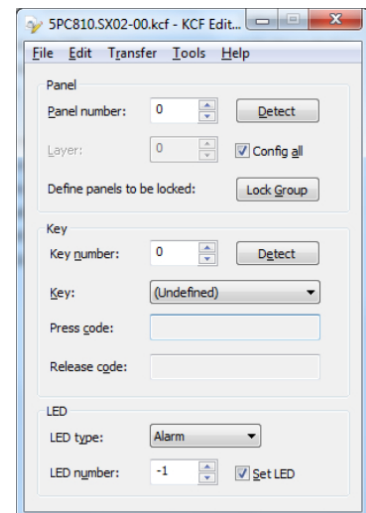

### Features:

- Configuration of normal keys like on a keyboard (A, B, C, etc.)
- Special key functions (change brightness, etc.)
- Assignment of LED functions (HDD access, power, etc.)
- 4 assignments possible per key (using layers)
- Configuration of the panel lock time when connecting several Automation Panel devices to B&R PCs.
- Export and import of the configuration (via INI files)
- Save configuration as report (text file)

If the KCF Editor is running on the target device and the ADI driver is installed, the following additional features are available:

- Panel and key detection
- LED test
- Download/Upload the configuration

For detailed instructions about configuring keys and LEDs and installing the key configuration on the target system, see the user documentation for the KCF Editor. The KCF Editor and user documentation can be downloaded at no cost from the Downloads section of the B&R website ([www.br-automation.com](http://www.br-automation.com)).

## 7.19 HMI Service Center

### 7.19.1 5SWUTI.0001-000

#### 7.19.1.1 General information

The HMI Service Center is software for testing B&R industrial PCs and Automation Panels. Testing covers different categories such as COM, network and SRAM.

The test system consists of a USB flash drive with installed Windows PE operating system and the HMI Service Center.

For details about the HMI Service Center, see the HMI Service Center user's manual. This can be downloaded at no cost from the B&R website ([www.br-automation.com](http://www.br-automation.com)).

#### 7.19.1.2 Order data

| Order number    | Short description  | Figure  |
|-----------------|--|---|
|                 | <b>Accessories</b>   |   |
| 5SWUTI.0001-000 | HMI Service Center USB flash drive - Hardware diagnostic software - For APC910/PPC900 - For PPC1200 - For APC2100/PPC2100 - For APC2200/PPC2200 - For APC3100/PPC3100 - For APC mobile - For AP800/AP900 - For AP9x3/AP9xD - For AP1000/AP5000 |  |

# 8 Maintenance

---

The following chapter describes the maintenance work that can be carried out by a qualified and trained end user.

## Information:

Only components approved by B&R are permitted to be used for maintenance work.

## 8.1 Cleaning

### Danger!

In order to prevent unintentional operation (by touching the touch screen or keys), the device is only permitted to be cleaned when the power is switched off.

- Use a cloth moistened with dishwashing detergent, screen cleaner or alcohol (ethanol) to clean the device.
- The cleaning agent is not permitted to be applied directly to the device. Abrasive cleaners, aggressive solvents and chemicals, compressed air or steam cleaners are not permitted to be used.
- When cleaning, areas with adhesive labels and product information should be left out to avoid damage.

## Information:

Displays with a touch screen should be cleaned at regular intervals.

## 8.2 User tips for increasing the service life of the display

### 8.2.1 Backlight

The service life of the backlight is specified by its "half-brightness time". An operating time of 50,000 hours would mean that the display brightness would still be 50% after this time.

#### 8.2.1.1 Measures to maintain backlight service life

- The display brightness can be set to the lowest level that is comfortable for the user's eyes.
- Bright images should be avoided as far as possible.
- A 50% reduction in brightness can increase the half-brightness time by about 50%.

### 8.2.2 Image persistence

Image persistence refers to the "burning in" of a static image on a display after being displayed for a long time. It does not only occur with static images, however. Image persistence is also referred to in the technical literature as screen burn-in, image retention, memory effect, memory sticking or ghost image.

There are 2 different types:

- Area type: This type can be seen in a dark gray image. The effect disappears if the display is switched off for a long time.
- Line type: This can result in permanent damage.

#### 8.2.2.1 What causes image persistence?

- Static images
- No screensaver
- Sharp transitions in contrast (e.g. black/white)
- High ambient temperatures
- Operation outside of specifications

### 8.2.2.2 How can image persistence be reduced?

- Switch continuously between static and dynamic images.
- Prevent excessive differences in brightness between foreground and background elements.
- Use colors with similar brightness.
- Use complementary colors for subsequent images.
- Use screensavers.

## 8.3 Information about display properties

The following limitations result from the current state of the technology and do not constitute any claims or warranty.

### **Pixel errors:**

Displays can contain faulty pixels (pixel errors) due to the manufacturing process.

### **Color variation:**

Displays can display colors or color ranges differently due to the manufacturing process, the properties of the components used, environmental influences and aging. This cannot be completely ruled out even with two similar devices of the same revision.

## 8.4 Replacing CFast cards

### Caution!

The CFast card is only permitted to be exchanged when the power is switched off!

Improper handling of the ejector lever (e.g. applying a large amount of force) can result in a defect in the ejector mechanism.

The CFast card can be exchanged quickly and easily by pressing the ejector (see figure) with a pointed object (e.g. ballpoint pen).

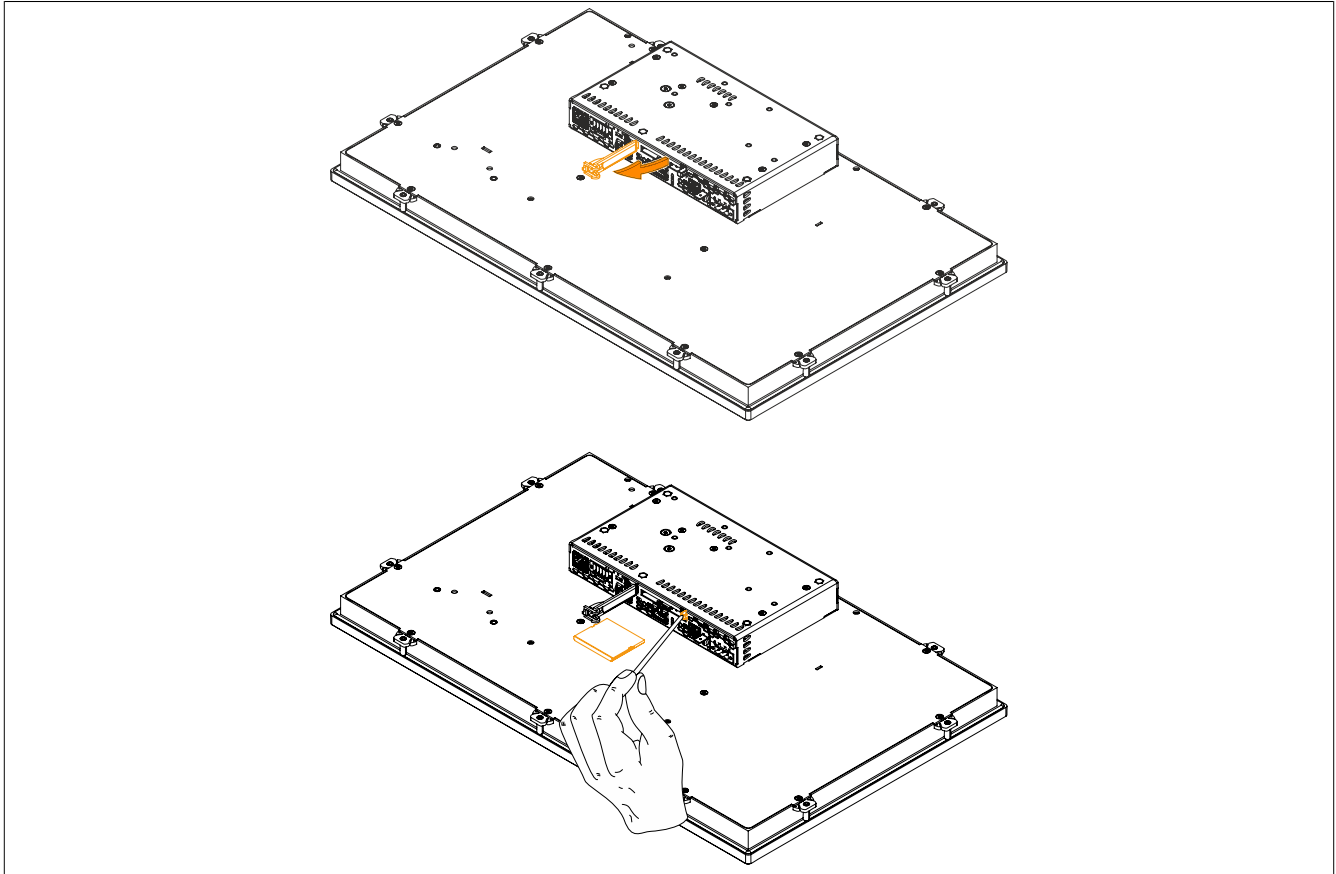

## 8.5 Repairs/Complaints and replacement parts

### Danger!

Unauthorized opening or repair of a device may result in personal injury and/or serious damage to property. Repairs are therefore only permitted to be carried out by authorized qualified personnel at the manufacturer's premises.

To process a repair/complaint, a repair order or complaint must be created via the B&R Material Return Portal on the B&R website ([www.br-automation.com](http://www.br-automation.com)).

## 9 International and national certifications

---

### 9.1 Directives and declarations

#### 9.1.1 CE marking



All directives applicable to the respective product and their harmonized EN standards are met.

#### 9.1.2 EMC Directive

The products meet the requirements of EU directive "Electromagnetic compatibility 2014/30/EU" and are designed for industrial applications:

|                   |   |
|-------------------|---|
| EN 61131-2:2007   | Programmable controllers - Part 2: Equipment requirements and tests   |
| EN 61000-6-2:2005 | Electromagnetic compatibility (EMC) - Part 6-2: Generic standards - Immunity for industrial environments          |
| EN 61000-6-4:2007 | Electromagnetic compatibility (EMC) - Part 6-4: Generic standards - Emission standard for industrial environments |

#### Information:

Declarations of conformity are available on the B&R website under [Downloads > Certificates > Declarations of conformity](#).

## 9.2 Certifications

### Danger!

**A complete system can only receive certification if all individual components installed and connected in it have the corresponding certifications. If an individual component is used that does not have the corresponding certification, the complete system will also not be certified.**

B&R products and services comply with applicable standards. These are international standards from organizations such as ISO, IEC and CENELEC, as well as national standards from organizations such as UL, CSA, FCC, VDE, ÖVE, etc. We pay special attention to the reliability of our products in the industrial sector.

### Information:

**The certifications valid for the respective product are available on the website and in the user's manual under the technical data in section "Certifications" or in the associated certificates.**

### 9.2.1 UL certification



Products with this mark are tested by Underwriters Laboratories and listed as "industrial control equipment". The mark is valid for the USA and Canada and simplifies the certification of your machines and systems in this economic area.

Underwriters Laboratories (UL) per standard UL 508  
Canadian (CSA) standard per C22.2 no. 142-M1987

UL certificates are available on the B&R website under [Downloads > Certificates > UL](#).

Ind. Cont. Eq.  
E115267

The device is classified as "open type" for use in the area of "Industrial control equipment" sector per UL 508. The device must therefore be installed in a UL 508-compliant protective housing as a requirement for certification or operation per UL 508.

The front of the device satisfies IP65 (EN 60529) and "Type 4X indoor use only" (UL 50E) requirements.

### 9.2.2 KC



Products with this mark are tested by an accredited test laboratory and permitted to be introduced into the Korean market (based on EU conformity).

### 9.2.3 UKCA



#### UK Conformity Assessed (UKCA)

All directives applicable to the respective product and their relevant standards are met. Products with this marking are permitted to be imported into Great Britain (England, Wales, Scotland).

### Information:

**Declarations of conformity are available on the B&R website under [Downloads > Certificates > Declarations of conformity](#).**

### 9.2.4 RCM



Products with this mark are tested by an accredited test laboratory and certified by the ACMA. The mark is valid for Australia/Oceania and simplifies the certification of your machines and systems in this economic area (based on EU conformity).

### 9.2.5 DNV certification



Products with this certification are certified by the classification society DNV and suitable for the maritime sector. DNV certificates (type approvals) are generally accepted by other classification societies during ship acceptance procedures. Products used on a ship's bridge must be dimmable using software in accordance with the regulations and guidelines from the respective classification society.

Windows 7 operating systems are only permitted to be used as embedded variants. There are no limitations for all other operating systems approved by B&R.

DNV certificates with specifications for permissible environmental conditions as well as a list of revisions from which the DNV type certification applies to individual devices are available on the B&R website ([Downloads > Certificates > Maritime](#)).

### 9.2.6 American Bureau of Shipping (ABS)



Products with this certification are suitable for use in the maritime sector according to the regulations of the classification society American Bureau of Shipping (ABS Rules).

Certificates with specifications for permissible environmental conditions as well as a list of revisions from which the certification applies to individual devices are available on the B&R website ([Downloads > Certificates > Maritime](#)).

### 9.2.7 Bureau Veritas (BV)



Products with this certification are suitable for use in the maritime sector according to the regulations of the classification society Bureau Veritas (BV).

Certificates with specifications for permissible environmental conditions as well as a list of revisions from which the certification applies to individual devices are available on the B&R website ([Downloads > Certificates > Maritime](#)).

### 9.2.8 Lloyd's Register (LR)



Products with this certification are suitable for use in the maritime sector according to the regulations of the classification society Lloyd's Register (LR).

Certificates with specifications for permissible environmental conditions as well as a list of revisions from which the certification applies to individual devices are available on the B&R website ([Downloads > Certificates > Maritime](#)).

### 9.2.9 Korean Register of Shipping (KR)



Products with this certification are suitable for use in the maritime sector according to the regulations of the classification society Korean Register of Shipping (KR).

Certificates with specifications for permissible environmental conditions are available on the B&R website ([Downloads > Certificates > Maritime](#)).

## 9.2.10 Certifications for use in potentially explosive environments

### 9.2.10.1 UL Haz. Loc. certification



Products with this mark are tested by Underwriters Laboratories and listed as "industrial control equipment for use in hazardous locations". The mark is valid for the USA and Canada and simplifies the certification of your machines and systems in this economic area.

Underwriters Laboratories (UL) per standard ANSI/ISA 12.12.01  
Canadian (CSA) standard per C22.2 no. 213-16

Ind. Cont. Eq.  
for Haz.Loc.  
Cl. I, Div. 2,  
Groups ABCD  
E180196 (T4)

The UL HazLoc certificates are available on the B&R website ([Downloads > Certificates > HazLoc](#)).

#### 9.2.10.1.1 General safety guidelines

PPC2100 systems with AP923 or AP1000 panels that are certified for use in potentially explosive environments and carry the marking above are suitable for use in Class 1, Division 2, Groups A, B, C and D or in nonexplosive environments and correspond to the following standards: UL 508 - 17th Edition, ANSI/ISA 12.12.01:2013, CSA C22.2 No. 213-M1987, and CSA C22.2 No. 157-92 (R2012).

#### 9.2.10.1.2 Mounting and installation

Devices with explosion protection are to be used as intended and are only permitted to be operated by knowledgeable and qualified personnel according to these operating instructions and the other information contained in the corresponding user's manual. Operation in any other way endangers the safety and functionality of the devices and the connected systems. The operator is responsible for following all applicable safety and accident prevention regulations, as well as adhering to standards.

Devices must be installed in a suitable protective housing that can only be opened by using a tool. In order to guarantee sufficient air circulation, allow the specified amount of space around the device. Use only in environments with pollution degree 2. The maximum ambient temperature varies depending on the individual components being used, see section "[Temperature specifications](#)" on page 34.

The certification marking on the device must be checked before each installation or use of the device in potentially explosive environments. Additional equipment must be suitable for the operating location. Final assembly must be approved by the relevant local authorities. Wiring must follow national regulations and meet all legal requirements.

Devices must remain voltage-free until installation work is complete. The tightening torque for the power supply terminals is 0.5 Nm. Cables must be able to handle a surface temperature of 75°C. PPC2100 systems with AP923 or AP1000 panels are only permitted to be operated with 24 VDC.

Unshielded/Ungrounded cables are never permitted to be used in potentially explosive areas. Devices must be securely connected to the potential offset. Power supply, communication and accessory cables must be secured on the device or control cabinet. Power supply, communication and accessory cables are not permitted to exert excessive tensile stress on the interfaces. Possible vibrations in the environment must be taken into account for this.

#### 9.2.10.1.3 Operation

To switch PPC2100 systems with AP923 or AP1000 panels on/off in a potentially explosive area, either the switch must be located outside the explosive area or a switch certified for use in potentially explosive areas must be used.

### **Danger!**

**Risk of explosion: Accessories are not permitted to be connected or disconnected when the power is switched on unless the area is considered nonhazardous and is free of ignitable concentrations!**

**Risk of explosion: Replacing components may impair eligibility for Class I, Division 2!**

**Danger !**

**Risque d'explosion – Ne pas connecter ou déconnecter un quelconque équipement lorsque le circuit est sous tension, à moins que la zone soit connue comme étant sans risque et sans concentrations inflammables!**

**Risque d'explosion – Le remplacement de composants peut compromettre l'aptitude au respect de la Classe I, Division 2!**

With the exception of USB dongle OTG1000.01 or in line with the requirements set forth in "[USB connection with the Panel PC 2100](#)" and "[USB connection with the Automation Panel 1000](#)", USB interfaces are not certified for operation in potentially explosive areas and may only be used for service purposes.

**9.2.10.1.4 Maintenance, breakdowns and disassembly**

Devices must be shut down and protected against accidental startup. A voltmeter must be used to verify that the power supply is cut off.

Before removing or installing accessories, components or cables, all power supplies to PPC2100 systems with AP923 or AP1000 panels must be interrupted. Defective devices must only be replaced by knowledgeable and qualified personnel. Before switching on or connecting the power supply, all covers and system components must be reinstalled and secured.

**Danger!**

**Failure to follow this instruction can result in death, serious bodily injury or damage to property!**

**Danger !**

**Le non-respect de ces instructions peut entraîner des blessures graves ou mortelles!**

### 9.2.10.1.5 USB connection with the Panel PC 2100

#### 9.2.10.1.5.1 Introduction

The information below describes the use of USB peripheral devices on USB interfaces 1 and 2 of the B&R Panel PC 2100 in Hazardous Locations Class I, Division 2, Groups A, B, C and D.

## Danger!

### EXPLOSION HAZARD

- Before installation or use in potentially explosive atmospheres, the explosion protection class of the device must be checked according to ANSI/ISA 12.12.01 and CSA C22.2 N°213.
- To switch on/off B&R devices installed in potentially explosive atmosphere, one of the following conditions must be met:
  - A switch outside the hazardous area must be used, or
  - A switch certified according to hazardous location class and division for "tube use" must be used.
- As long as the electrical circuit is activated, cables or lines are not permitted to be connected or disconnected unless the area is knowingly free of flammable concentrations of vapors, gases and other flammable or combustible materials. This applies to all connections and circuits. This includes power, ground and network connections as well as series and parallel connections.
- Unshielded/Ungrounded cables are never permitted to be used in potentially explosive atmospheres.
- Only configurations with nonincendive USB devices are permitted to be used.
- The doors and openings of housings must always remain closed. This prevents the accumulation of foreign bodies within the workstation.

Failure to follow this instruction can result in death, serious bodily injury or damage to property!

#### 9.2.10.1.5.2 Description

Nonincendive devices (keyboards, mouse) are certified for use on the rear USB interfaces of the B&R Panel PC 2100 (connected device) and are permitted to be connected and disconnected during operation. In addition to the nonincendive property, devices that can be connected to rear USB interfaces 1 and 2 must meet the following criteria.

The figure shows the USB cable wiring:

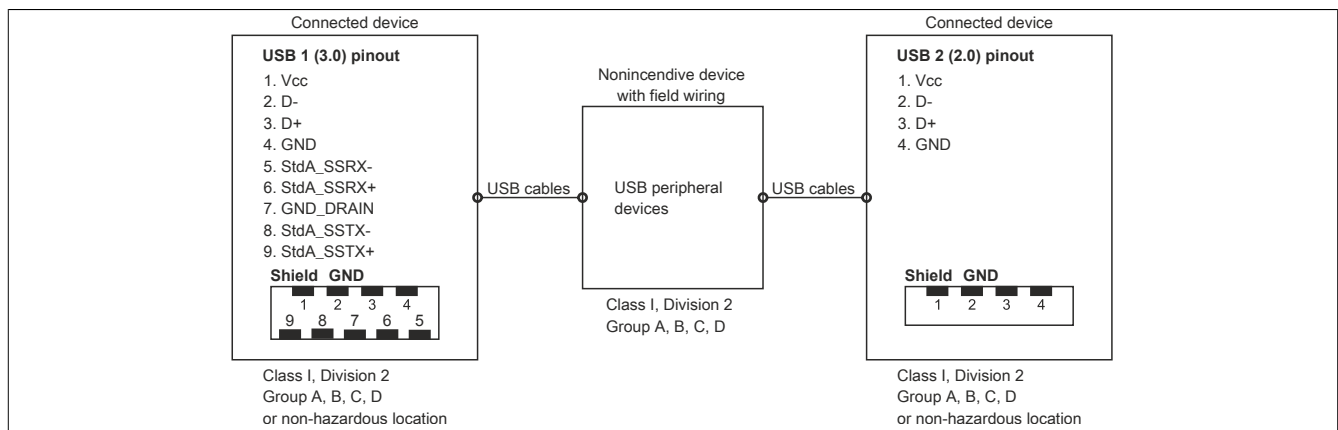

The following tables indicate the nonincendive electrical circuit parameters:

| Interface USB1 (USB 3.0):                |         |
|--|---------|
| No-load voltage [V <sub>oc</sub> ]       | 5.13 V  |
| Short circuit current [I <sub>sc</sub> ] | 2060 mA |
| Associated capacitance [C <sub>a</sub> ] | 20 µF   |
| Associated inductance [L <sub>a</sub> ]  | 4.8 µH  |

Table 101: Nonincendive circuit parameters for interface USB1

| Interface USB2 (USB 2.0):          |             |
|------------------------------------|-------------|
| No-load voltage [ $V_{oc}$ ]       | 5.13 V      |
| Short circuit current [ $I_{sc}$ ] | 2060 mA     |
| Associated capacitance [ $C_a$ ]   | 20 $\mu$ F  |
| Associated inductance [ $L_a$ ]    | 4.8 $\mu$ H |

Table 102: Nonincendive circuit parameters for interface USB2

The unit concept allows the interconnection of nonincendive devices with connected devices with non-specifically tested combinations as a system. For this purpose, the permissible values of  $V_{oc}$  (or  $U_o$ ) and  $I_{sc}$  (or  $I_o$ ) for the connected device must be less than or equal to  $V_{max}$  ( $U_i$ ) and  $I_{max}$  ( $I_i$ ) for the nonincendive device, the permissible values of  $C_a$  ( $C_o$ ) and  $L_a$  ( $L_o$ ) for the connected device must be greater than or equal to  $C_i + C_{Cable}$  and  $L_i + L_{Cable}$  for the nonincendive device with field wiring.

The nonincendive device with field wiring must meet the following criteria:

| B&R device (connected device) | -      | Connected, nonincendive device with field wiring (mouse, keyboard) |
|-------------------------------|--------|--|
| $V_{oc}$                      | $\leq$ | $V_{max}$  |
| $I_{sc}$                      | $\leq$ | $I_{max}$  |
| $C_a$                         | $\geq$ | $C_i + C_{Cable}$  |
| $L_a$                         | $\geq$ | $L_i + L_{Cable}$  |

Table 103: Connected, nonincendive device with field wiring

If the electrical parameters of the cable are unknown, the following values can be used:

Where  $C_{Cable} = 196.85$  pF/m (60 pF/ft) if unknown

Where  $L_{Cable} = 0.656$   $\mu$ H/m (0.20  $\mu$ H/ft) if unknown

Wiring must be carried out in accordance with national regulations and the requirements of the authorities.

The B&R device must be installed in a suitable protective housing. For installations in Class I, Division 2 hazardous locations, the housing must be capable of withstanding one or more Division 2 wiring methods.

## Warning!

- Replacing components may impair the suitability of the Division 2 hazardous location (classified) under certain circumstances.
- As long as the area is knowingly at risk of explosion, the device is not permitted to be switched on or off.
- The nonincendive device with field wiring is not permitted to be connected via a parallel connection. This is valid unless the device has received express permission for this.

The B&R device is suitable for use in Class I, Division 2, Groups A, B, C and D areas. It also provides nonincendive field wiring for devices in Class I, Division 2, Groups A, B, C and D.

### 9.2.10.1.6 USB connection with the Automation Panel 1000

#### 9.2.10.1.6.1 Introduction

The information below describes the use of USB peripheral devices on the front USB interface of the B&R Automation Panel 1000 in hazardous locations Class I, Division 2, Groups A, B, C and D.

## Danger!

### RISK OF EXPLOSION

- Before installation or use in potentially explosive atmospheres, the explosion protection class of the device must be checked according to ANSI/ISA 12.12.01 and CSA C22.2 N°213.
- To switch on/off B&R devices that are installed in potentially explosive atmospheres, at least one of the following conditions must be met:
  - A suitable switch installed outside the hazardous area is used.
  - A switch certified according to the hazardous location class and division for *tube use* is used.
- As long as the electrical circuit is activated, cables or lines are not permitted to be connected or disconnected unless the area is knowingly free of flammable concentrations of vapors, gases and other flammable or combustible materials. This applies to all connections and circuits. This includes power, ground and network connections as well as series and parallel connections.
- Unshielded/Ungrounded cables are never permitted to be used in potentially explosive atmospheres.
- Only configurations with nonincendive USB devices are permitted to be used.
- The doors and openings of housings must always remain closed. This prevents the accumulation of foreign bodies within the workstation.

Failure to follow this instruction can result in death, serious bodily injury or damage to property!

#### 9.2.10.1.6.2 Description

Nonincendive devices (keyboards, mouse) are certified for use on the front USB interface of the B&R Automation Panel 1000 (connected device) and are permitted to be connected and disconnected during operation. In addition to the nonincendive property, devices that can be connected to the front USB interface must meet the following criteria.

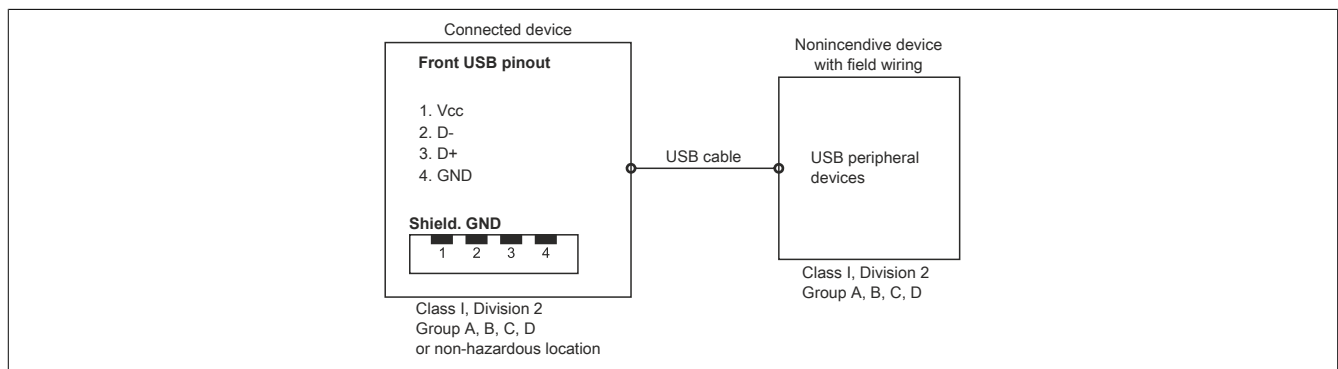

| Front USB interface (USB 2.0):           |         |
|--|---------|
| Open-circuit voltage [V <sub>oc</sub> ]  | 5.04 V  |
| Short-circuit current [I <sub>sc</sub> ] | 1170 mA |
| Connected capacity [C <sub>a</sub> ]     | 20 μF   |
| Connected inductance [L <sub>a</sub> ]   | 16.8 μH |

Table 104: Nonincendive electrical circuit parameters for the front USB interface

The unit concept allows the interconnection of nonincendive devices with connected devices with non-specifically tested combinations as a system. For this purpose, the permissible values of V<sub>oc</sub> (or U<sub>o</sub>) and I<sub>sc</sub> (or I<sub>o</sub>) for the connected device must be less than or equal to V<sub>max</sub> (U<sub>i</sub>) and I<sub>max</sub> (I<sub>i</sub>) for the nonincendive device, the permissible values of C<sub>a</sub> (C<sub>o</sub>) and L<sub>a</sub> (L<sub>o</sub>) for the connected device must be greater than or equal to C<sub>i</sub> + C<sub>Cable</sub> and L<sub>i</sub> + L<sub>Cable</sub> for the nonincendive device with field wiring.

The nonincendive device with field wiring must meet the following criteria:

| B&R device (connected device) | -      | Connected, nonincendive device with field wiring (mouse, keyboard) |
|-------------------------------|--------|--|
| $V_{oc}$                      | $\leq$ | $V_{max}$  |
| $I_{sc}$                      | $\leq$ | $I_{max}$  |
| $C_a$                         | $\geq$ | $C_i + C_{cable}$  |
| $L_a$                         | $\geq$ | $L_i + L_{cable}$  |

Table 105: Connected, nonincendive device with field wiring

If the electrical parameters of the cable are unknown, the following values can be used:

Where  $C_{Cable} = 196.85 \text{ pF/m}$  (60 pF/ft) if unknown

Where  $L_{Cable} = 0.656 \text{ }\mu\text{H/m}$  (0.20  $\mu\text{H/ft}$ ) if unknown

Wiring must be carried out in accordance with national regulations and the requirements of the authorities.

The B&R device must be installed in a suitable protective housing. For installations in Class I, Division 2 hazardous locations, the housing must be capable of withstanding one or more Division 2 wiring methods.

## Warning!

- Replacing components may impair the suitability of the Division 2 hazardous location (classified) under certain circumstances.
- As long as the area is knowingly at risk of explosion, the device is not permitted to be switched on or off.
- The nonincendive device with field wiring is not permitted to be connected via a parallel connection. This is valid unless the device has received express permission for this.

The B&R device is suitable for use in Class I, Division 2, Groups A, B, C and D areas. It also provides nonincendive field wiring for devices in Class I, Division 2, Groups A, B, C and D.

### 9.2.10.1.7 USB connection with the 4-port hub

#### 9.2.10.1.7.1 Introduction

The information below describes the use of USB peripheral devices for the B&R 4-port USB hub in hazardous locations Class I, Division 2, Groups A, B, C and D.

## Danger!

### RISK OF EXPLOSION

- Before installation or use in potentially explosive atmospheres, the explosion protection class of the device must be checked according to ANSI/ISA 12.12.01 and CSA C22.2 N°213.
- To switch on/off B&R devices that are installed in potentially explosive atmospheres, at least one of the following conditions must be met:
  - A suitable switch installed outside the hazardous area is used.
  - A switch certified according to the hazardous location class and division for *tube use* is used.
- As long as the electrical circuit is activated, cables or lines are not permitted to be connected or disconnected unless the area is knowingly free of flammable concentrations of vapors, gases and other flammable or combustible materials. This applies to all connections and circuits. This includes power, ground and network connections as well as series and parallel connections.
- Unshielded/Ungrounded cables are never permitted to be used in potentially explosive atmospheres.
- Only configurations with nonincendive USB devices are permitted to be used.
- The doors and openings of housings must always remain closed. This prevents the accumulation of foreign bodies within the workstation.

Failure to follow this instruction can result in death, serious bodily injury or damage to property!

#### 9.2.10.1.7.2 Description

Nonincendive devices (keyboards, mouse) are certified for use on the B&R 4-port hub (connected device) and are permitted to be connected and disconnected during operation. In addition to the nonincendive property, devices that can be connected to the USB interfaces must meet the following criteria.

The figure shows a wiring diagram of the USB cable:

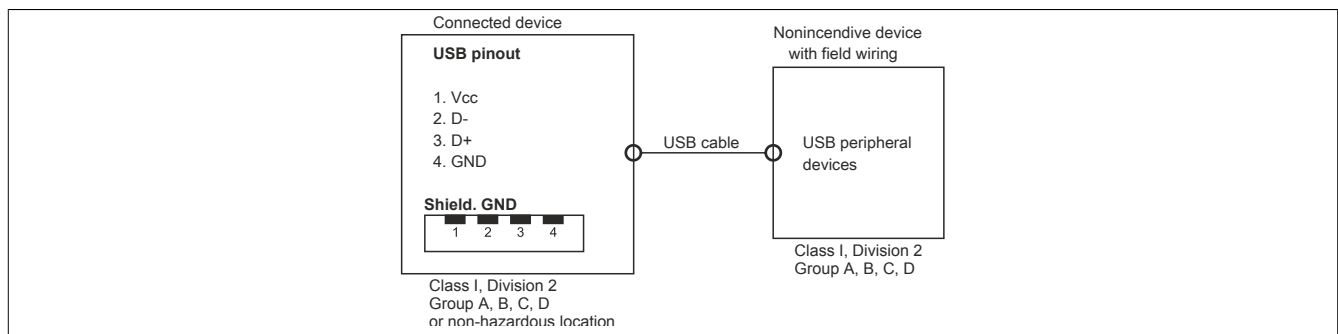

The following table shows the nonincendive circuit parameters of the 4-port hub USB interfaces:

| USB interfaces (USB 2.0):                |         |
|--|---------|
| No-load voltage [V <sub>oc</sub> ]       | 5.11 V  |
| Short circuit current [I <sub>sc</sub> ] | 1621 mA |
| Associated capacitance [C <sub>a</sub> ] | 20 μF   |
| Associated inductance [L <sub>a</sub> ]  | 16.8 μH |

The unit concept allows the interconnection of nonincendive devices with connected devices with non-specifically tested combinations as a system. For this purpose, the permissible values of V<sub>oc</sub> (or U<sub>o</sub>) and I<sub>sc</sub> (or I<sub>o</sub>) for the connected device must be less than or equal to V<sub>max</sub> (U<sub>i</sub>) and I<sub>max</sub> (I<sub>i</sub>) for the nonincendive device, the permissible values of C<sub>a</sub> (C<sub>o</sub>) and L<sub>a</sub> (L<sub>o</sub>) for the connected device must be greater than or equal to C<sub>i</sub> + C<sub>Cable</sub> and L<sub>i</sub> + L<sub>Cable</sub> for the nonincendive device with field wiring.

The nonincendive device with field wiring must meet the following criteria:

| B&R device (connected device) | -      | Connected, nonincendive device with field wiring (mouse, keyboard) |
|-------------------------------|--------|--|
| $V_{oc}$                      | $\leq$ | $V_{max}$  |
| $I_{sc}$                      | $\leq$ | $I_{max}$  |
| $C_a$                         | $\geq$ | $C_i + C_{cable}$  |
| $L_a$                         | $\geq$ | $L_i + L_{cable}$  |

If the electrical parameters of the cable are unknown, the following values can be used:

Where  $C_{Cable} = 196.85 \text{ pF/m}$  (60 pF/ft) if unknown

Where  $L_{Cable} = 0.656 \text{ }\mu\text{H/m}$  (0.20  $\mu\text{H/ft}$ ) if unknown

Wiring must be carried out in accordance with national regulations and the requirements of the authorities.

The B&R device must be installed in a suitable protective housing. For installations in Class I, Division 2 hazardous locations, the housing must be capable of withstanding one or more Division 2 wiring methods.

## Warning!

- **Replacing components may impair the suitability of the Division 2 hazardous location (classified) under certain circumstances.**
- **As long as the area is knowingly at risk of explosion, the device is not permitted to be switched on or off.**
- **The nonincendive device with field wiring is not permitted to be connected via a parallel connection. This is valid unless the device has received express permission for this.**

The B&R device is suitable for use in Class I, Division 2, Groups A, B, C and D areas. It also provides nonincendive field wiring for devices in Class I, Division 2, Groups A, B, C and D.

# 10 Accessories

---

The following accessories have undergone functional testing by B&R in connection with the device used and can be operated with this device. Possible limitations regarding operation with individual components other than the complete system must be taken into account, however. All individual specifications of the components must be observed when operating the complete system.

All components listed in this manual have undergone intensive system and compatibility testing and been approved accordingly. B&R cannot assume any functional warranty for accessories that have not been approved.

## 10.1 General accessories

The following accessories can be ordered for the Automation PC, Panel PC link modules and converters:

- Grounding clip

### 10.1.1 Accessories - Order data

| Material number   | Description            |
|-------------------|------------------------|
| 5ACCRHMI.0000-000 | REP HMI grounding clip |

## 10.2 Installation accessories

Suitable tool sets can be ordered to easily install B&R industrial PCs and converters.

- Consisting of:

### 5ACCRHMI.0006-000

- 1x torque screwdriver: 0.4 to 2.0 Nm
- 1x bit set (5 pieces): Hex recess (2.5 mm, 3.0 mm, 5.0 mm), Torx (T10, T20)

### 10.2.1 Order data

| Order number      | Short description  | Figure  |
|-------------------|--|---|
| 5ACCRHMI.0006-000 | <p><b>Other</b></p> <p>HMI installation tool for control cabinet - 1x torque wrench 0.4 - 2.0 Nm - 1x hex head bit 2.5, length 89 mm - 1x hex head bit 3.0, length 89 mm - 1x hex head bit 5.0, length 89 mm - 1x Torx 10 bit, length 90 mm - 1x Torx 20 bit, length 89 mm</p> |  |

## 10.3 Terminal block power supply

### 10.3.1 0TB103.9x

#### 10.3.1.1 General information

One-row 3-pin terminal block 0TB103.9x is used for the power supply.

#### 10.3.1.2 Order data

| Order number | Short description  | Figure  |
|--------------|--|---|
|              | <b>Accessories</b>   |  |
| 0TB103.9     | Connector 24 VDC - 3-pin, female - Screw clamp terminal block 3.31 mm <sup>2</sup> |   |
| 0TB103.91    | Connector 24 VDC - 3-pin, female - Cage clamp terminal block 3.31 mm <sup>2</sup>  |   |

#### 10.3.1.3 Technical data

### Information:

The following specified characteristic data, features and limit values are only valid for this accessory and may differ from those of the complete system. The data specified for the complete system applies to the complete system in which an accessory is used.

| Order number                           | 0TB103.9   | 0TB103.91   |
|--|--|---|
| <b>General information</b>             |  |   |
| Certifications                         |  |   |
| CE                                     |  | Yes   |
| UKCA                                   |  | Yes   |
| UL                                     |  | cULus E115267<br>Industrial control equipment   |
| HazLoc                                 |  | cULus HazLoc E180196<br>Industrial control equipment<br>for hazardous locations<br>Class I, Division 2, Groups ABCD, T4                     |
| DNV                                    |  | Temperature: <b>B</b> (0 to 55°C)<br>Humidity: <b>B</b> (up to 100%)<br>Vibration: <b>A</b> (0.7 g)<br>EMC: <b>B</b> (bridge and open deck) |
| LR                                     |  | ENV3  |
| KR                                     |  | Yes   |
| ABS                                    |  | Yes   |
| BV                                     |  | <b>EC31B</b><br>Temperature: 5 - 55°C<br>Vibration: 0.7 g<br>EMC: Bridge and open deck  |
| <b>Terminal block</b>                  |  |   |
| Note                                   | Protected against vibration by the screw flange<br>Nominal data per UL |   |
| Number of pins                         | 3 (female)   |   |
| Type of terminal block                 | Screw clamp terminal block variant                                     | Cage clamp terminal block variant <sup>1)</sup>   |
| Cable type                             | Only copper wires (no aluminum wires!)                                 |   |
| Pitch                                  | 5.08 mm  |   |
| Connection cross section               |  |   |
| AWG wire                               | 26 to 14 AWG   | 26 to 12 AWG  |
| Wire end sleeves with plastic covering |  | 0.20 to 1.50 mm <sup>2</sup>  |
| Single-wire                            |  | 0.20 to 2.50 mm <sup>2</sup>  |
| Fine-stranded wires                    | 0.20 to 1.50 mm <sup>2</sup>   | 0.20 to 2.50 mm <sup>2</sup>  |
| With wire end sleeves                  |  | 0.20 to 1.50 mm <sup>2</sup>  |
| Tightening torque                      | 0.4 Nm   | -   |
| <b>Electrical properties</b>           |  |   |
| Nominal voltage                        |  | 150 V   |
| Nominal current <sup>2)</sup>          | 13 A / contact   | 15 A / contact  |
| Contact resistance                     |  | ≤5 mΩ   |
| <b>Operating conditions</b>            |  |   |
| Pollution degree per EN 61131-2        |  | Pollution degree 2  |

1) The cage clamp terminal block cannot be used side by side.

2) The respective limit data of the I/O modules must be taken into account!

## 10.4 Terminal block for IF options

### 10.4.1 0TB1210.3100

#### 10.4.1.1 General information

Two-row 10-pin terminal block 0TB1210.3100 is used to connect to the interfaces of various interface options.

#### 10.4.1.2 Order data

| Order number | Short description   | Figure  |
|--------------|---|---|
|              | <b>Terminal blocks</b>  |   |
| 0TB1210.3100 | Connector 300 VDC - 10-pin female - Cage clamp terminal block - Protected against vibration by the screw flange |  |

#### 10.4.1.3 Technical data

##### Information:

The following specified characteristic data, features and limit values are only valid for this accessory and may differ from those of the complete system. The data specified for the complete system applies to the complete system in which an accessory is used.

| Order number                           | 0TB1210.3100  |
|--|---|
| <b>General information</b>             |   |
| Certifications                         |   |
| CE                                     | Yes   |
| UKCA                                   | Yes   |
| UL                                     | cULus E115267<br>Industrial control equipment   |
| HazLoc                                 | cULus HazLoc E180196<br>Industrial control equipment<br>for hazardous locations<br>Class I, Division 2, Groups ABCD, T4                     |
| DNV                                    | Temperature: <b>B</b> (0 to 55°C)<br>Humidity: <b>B</b> (up to 100%)<br>Vibration: <b>A</b> (0.7 g)<br>EMC: <b>B</b> (bridge and open deck) |
| LR                                     | ENV3  |
| KR                                     | Yes   |
| ABS                                    | Yes   |
| BV                                     | <b>EC31B</b><br>Temperature: 5 - 55°C<br>Vibration: 0.7 g<br>EMC: Bridge and open deck  |
| <b>Terminal block</b>                  |   |
| Note                                   | Nominal data per UL   |
| Number of pins                         | 10 (female)   |
| Type of terminal block                 | Push-in spring connection   |
| Cable type                             | Only copper wires (no aluminum wires!)  |
| Pitch                                  | 3.5 mm  |
| Connection cross section               |   |
| AWG wire                               | 26 to 16 AWG  |
| Wire end sleeves with plastic covering | 0.14 to 1 mm <sup>2</sup>   |
| Single-wire                            | 0.14 to 1.5 mm <sup>2</sup>   |
| Fine-stranded wires                    | 0.14 to 1.5 mm <sup>2</sup>   |
| With wire end sleeves                  | 0.14 to 1.5 mm <sup>2</sup>   |
| <b>Electrical properties</b>           |   |
| Nominal voltage                        | 300 V   |
| Nominal current <sup>1)</sup>          | 10 A  |
| <b>Operating conditions</b>            |   |
| Pollution degree per EN 61131-2        | Pollution degree 2  |

1) The respective limit data of the I/O modules must be taken into account!

## 10.5 USB mass storage device

For additional information about compatible USB mass storage devices, see the B&R website ([USB mass storage devices](#)).

## 10.6 USB hub

### 10.6.1 5ACCUSB4.0000-000

#### 10.6.1.1 General information

- USB hub 5ACCUSB4.0000-000 can be used starting with a display diagonal of the panel of at least 10.1".
- The USB hub can be installed starting with the following revisions of the system units:

| System unit       | Minimum revision | System unit       | Minimum revision |
|-------------------|------------------|-------------------|------------------|
| 5PPC2100.BY01-000 | F0               | 5PPC2100.BY11-000 | F0               |
| 5PPC2100.BY22-000 | F0               | 5PPC2100.BY34-000 | F0               |
| 5PPC2100.BY44-000 | G0               | 5PPC2100.BY48-000 | A0               |

#### Features

- 4x USB 2.0, interfaces
- Compatible with the APC2100 and PPC2100

#### Installation

For details about installing the USB hub, see section "Installing the USB hub" on page 179.

#### 10.6.1.2 Order data

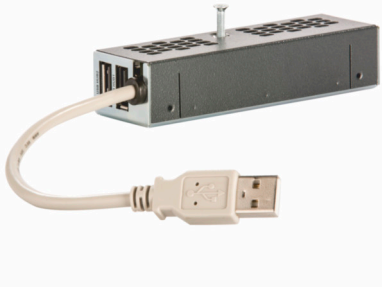
| Order number       | Short description  | Figure   |
|--------------------|--|--|
|                    | <b>Accessories</b>   |  |
| 5ACCUSB4.0000-000  | USB hub 4x passive - For APC2100/PPC2100                     |  |
|                    | <b>Required accessories</b>                                  |  |
|                    | <b>Front covers</b>  |  |
| 5ACCCFF00.0001-000 | APC2100 front cover - Orange - With B&R logo - For USB hub   |  |
| 5ACCCFF00.0001-001 | APC2100 front cover - Dark gray - Without logo - For USB hub |  |
| 5ACCCFF00.0001-002 | APC2100 front cover - Orange - Without logo - For USB hub    |  |

#### 10.6.1.3 Technical data

### Information:

The following specified characteristic data, features and limit values are only valid for this accessory and may differ from those of the complete system. The data specified for the complete system applies to the complete system in which an accessory is used.

| Order number                      | 5ACCUSB4.0000-000   |
|-----------------------------------|---|
| <b>General information</b>        |   |
| B&R ID code                       | 0xEABA  |
| <b>Certifications</b>             |   |
| CE                                | Yes   |
| UKCA                              | Yes   |
| UL                                | cULus E115267<br>Industrial control equipment   |
| HazLoc                            | cULus HazLoc E180196<br>Industrial control equipment<br>for hazardous locations<br>Class I, Division 2, Groups ABCD, T4 |
| EAC                               | Product family certification  |
| <b>Interfaces</b>                 |   |
| <b>USB</b>                        |   |
| Quantity                          | 4   |
| Type                              | USB 2.0   |
| Variant                           | Type A  |
| Transfer rate                     | Low speed (1.5 Mbit/s), full speed (12 Mbit/s) to high speed (480 Mbit/s)   |
| Current-carrying capacity         | Total max. 1 A (sum of all 4 ports)   |
| <b>Operating conditions</b>       |   |
| Pollution degree per EN 61131-2   | Pollution degree 2  |
| Degree of protection per EN 60529 | Back: IP20 (front: depends on the panel used) <sup>1)</sup>   |

| Order number                 | 5ACCUSB4.0000-000         |
|------------------------------|---------------------------|
| <b>Ambient conditions</b>    |                           |
| Temperature                  |                           |
| Operation                    | 0 to 60°C <sup>2)</sup>   |
| Storage                      | -20 to 60°C               |
| Transport                    | -20 to 60°C               |
| Relative humidity            |                           |
| Operation                    | 5 to 90%, non-condensing  |
| Storage                      | 5 to 95%, non-condensing  |
| Transport                    | 5 to 95%, non-condensing  |
| Elevation                    |                           |
| Operation                    | Max. 3000 m <sup>2)</sup> |
| <b>Mechanical properties</b> |                           |
| Housing                      |                           |
| Material                     | Stainless steel, coated   |
| Coating                      | Anthracite gray           |
| Dimensions                   |                           |
| Width                        | 21.5 mm                   |
| Height                       | 29.5 mm                   |
| Depth                        | 97 mm                     |
| Weight                       | 100 g                     |

1) Only if all interface covers are installed.

2) The maximum ambient temperature is typically derated 1°C per 1000 meters starting at 500 m above sea level.

### 10.6.1.3.1 USB interfaces

The 4-port USB hub is equipped with a USB 2.0 (Universal Serial Bus) host controller with several USB ports, of which four USB 2.0 interfaces are routed externally and freely available to the user.

#### Warning!

USB peripheral devices can be connected to the USB interfaces. Due to the variety of USB devices available on the market, B&R cannot guarantee their functionality. The functionality of USB devices available from B&R is ensured.

#### Caution!

Due to the general PC specification, this interface must be handled with the utmost care with regard to EMC, cable routing, etc.

### USB HUB 1 - USB HUB 4

| USB HUB 1 - USB HUB 4                   |                                     |
|---|-------------------------------------|
| Standard                                | USB 2.0                             |
| Variant                                 | Type A, female                      |
| Quantity                                | 4                                   |
| Transfer rate                           | Low speed (1.5 Mbit/s)              |
|   | Full speed (12 Mbit/s)              |
|   | High speed (480 Mbit/s)             |
| Current-carrying capacity <sup>1)</sup> | Total max. 1 A (sum of all 4 ports) |
| Cable length                            |                                     |
| USB2.0                                  | Max. 5 m                            |

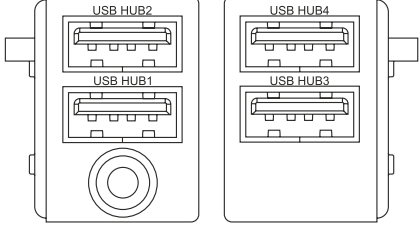

1) The USB hub is protected by a maintenance-free "USB current-limiting switch" (max. 1 A).

#### Information:

If a Technology Guard (USB dongle) is used, it is recommended to connect it to the USB HUB 3 interface.

### 10.6.1.4 Dimensions

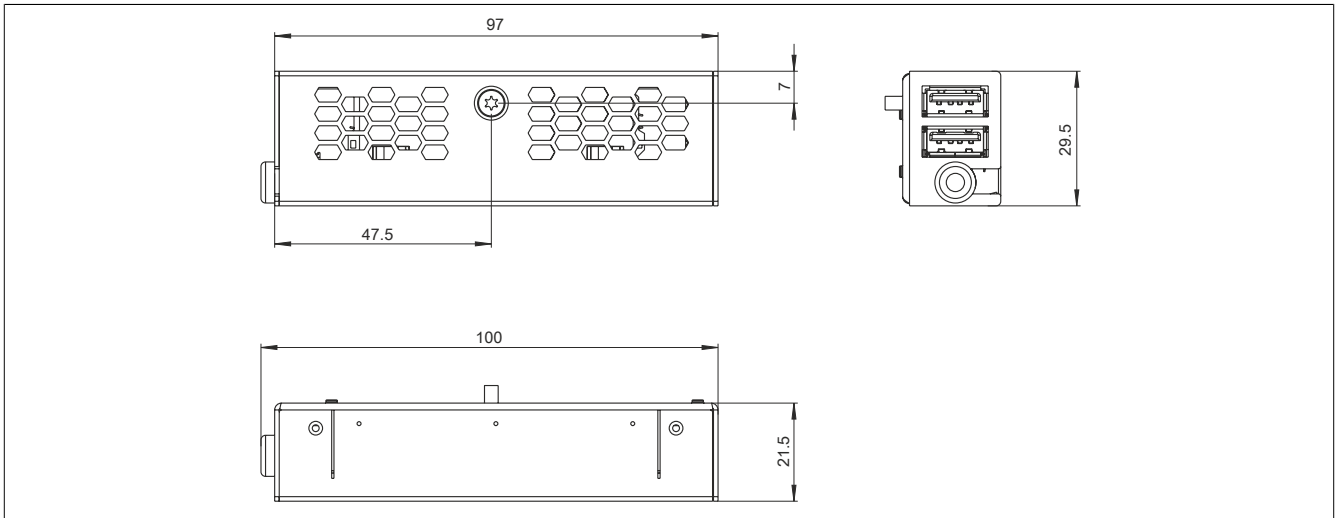

### 10.7 Cables

For additional information about compatible cables, see the B&R website ([HMI cable manual](#)).

## 10.8 Replacement parts

The following replacement parts can be ordered for the PPC2100:

- Mounting screws for PPC2100
- Slot cover for interfaces
- Cover for CFast slot

### 10.8.1 Replacement parts - Order data

| Material number   | Description   |
|-------------------|---|
| 5ACCRPC2.0000-000 | PPC2100/2200 mounting screws kit - 4x screw M3x34 mm - 2x special screw for PPC2100 |
| 5ACCRPC2.0001-000 | xPC2100/2200 interface covers - 1x cover set  |

# 11 Environmentally friendly disposal

---

All programmable logic controllers, operating and monitoring devices and uninterruptible power supplies from B&R are designed to have as little impact on the environment as possible.

## 11.1 Separation of materials

To ensure that devices can be recycled in an environmentally friendly manner, it is necessary to separate out the different materials.

| Component  | Disposal                  |
|--|---------------------------|
| Programmable logic controllers<br>Operating and monitoring devices<br>Uninterruptible power supplies<br>Batteries and rechargeable batteries<br>Cables | Electronics recycling     |
| Paper/Cardboard packaging  | Paper/Cardboard recycling |
| Plastic packaging material   | Plastic recycling         |

Disposal must be carried out in accordance with applicable legal regulations.

# Appendix A

---

## A.A Abbreviations

Abbreviations used in the document are explained here.

| Abbreviation | Stands for                      | Description   |
|--------------|---------------------------------|---|
| NC           | Normally closed                 | Stands for a normally closed relay contact.   |
|              | Not connected                   | Used in pinout descriptions if a terminal or pin is not connected on the module side.   |
| ND           | Not defined                     | Stands for an undefined value in technical data tables. This may be because the cable manufacturer has not provided a value for certain technical data. |
| NO           | Normally open                   | Stands for a normally open relay contact.   |
| TBD          | To be defined                   | Used in technical data tables if there is currently no value for specific technical data. The value will be supplied later.                             |
| $B_{100}$    | -                               | Number of cycles until 10% of the components fail dangerously (per channel).  |
| MTBF         | Mean time between failures      | The expected value of the operating time between two consecutive failures.  |
| $MTTF_D$     | Mean time to dangerous failure  | Mean time to dangerous failure (per channel).   |
| DC           | Diagnostic coverage             | Degree of diagnostic coverage   |
| PL           | Performance level               | Discrete level specifying the ability of safety-related devices to perform a safety function under foreseeable conditions.                              |
| PFH          | Probability of failure per hour | Probability of a failure per hour.  |
| SIL          | Safety integrity level          | Safety integrity level  |

## A.B Maintenance Controller Extended (MTCX)

The MTCX controller (FPGA processor) is located on the mainboard (part of each system unit) of the APC2100 and PPC2100 device.

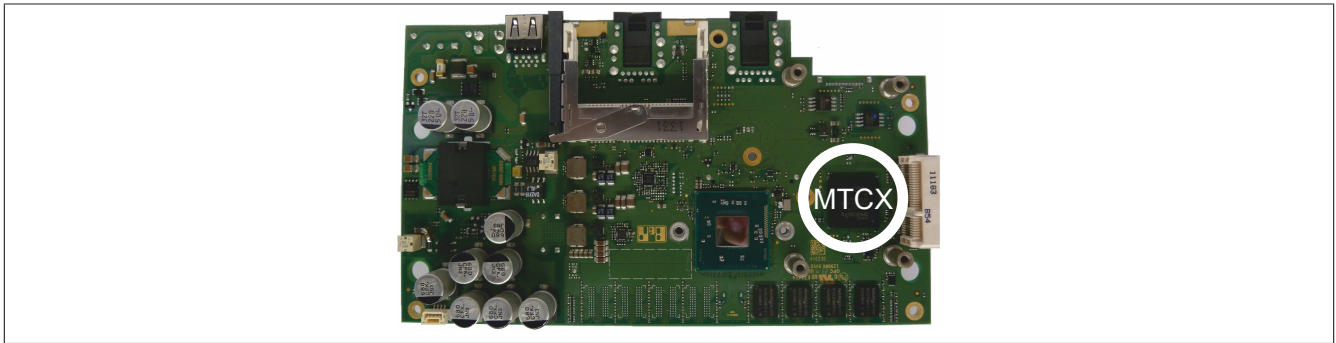

The MTCX is responsible for the following monitoring and control functions:

- Switching on (power OK sequencing) and power failure logic
- Watchdog handling (NMI and reset handling)
- Temperature monitoring
- Fan control
- Handling/Coordination of keys and LEDs (matrix keyboard of B&R panels)
- Advanced desktop operation (buttons, USB forwarding)
- Daisy chain display operation (touch screen, USB forwarding)
- Panel locking mechanism (configurable via the B&R Control Center - ADI driver)
- Backlight control of a connected B&R display
- Calculating statistical data: Power-on cycles, power-on hours and fan hours (resolution: 15 min)
- SDL data transfer (display, matrix keyboard, touch screen, service data, USB)
- LED status indicators (Power, HDD, Link, Run)
- Optimal default BIOS settings are reported to BIOS by the MTCX depending on the existing hardware.

The functions of the MTCX can be extended by upgrading its firmware<sup>5)</sup>. The version can be read in BIOS or in approved Microsoft Windows operating systems using the B&R Control Center.

<sup>5)</sup> Can be downloaded from the Downloads section of the B&R website ([www.br-automation.com](http://www.br-automation.com)).

## A.C Viewing angles

For viewing angle specifications (R, L, U, D) of the display types, see the technical data of the individual components.

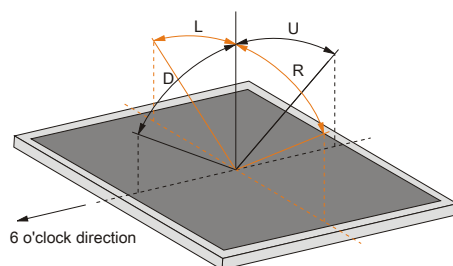

## A.D Chemical resistance

All panels are made of a coated aluminum support frame.

### Single-touch panels

- AP1000 single-touch panels are manufactured with an Autotex panel overlay.
- AP9x3 single-touch panels are manufactured with an Autotex panel overlay starting with the following revision:
  - 5AP923.1215-00 ≥ revision B8
  - 5AP923.1505-00 ≥ revision B8
  - 5AP923.1906-00 ≥ revision B8

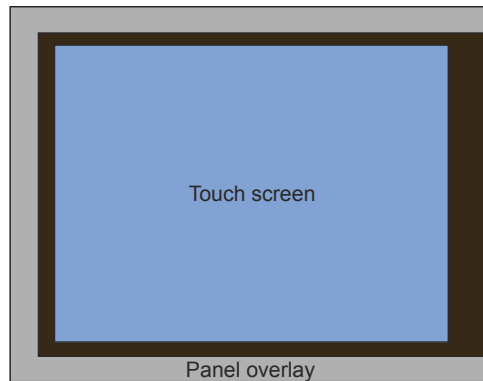

- AP9x3 single-touch panels < revision B8 were manufactured with an aluminum panel overlay.

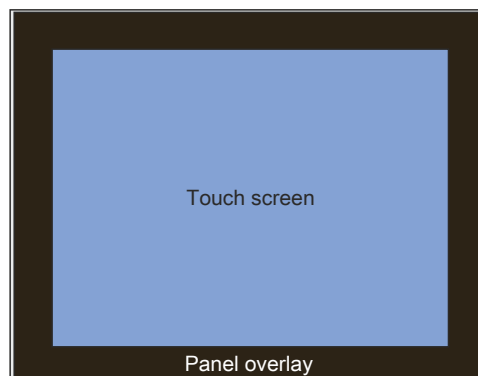

### Multi-touch panels

- AP9x3 and AP1000 multi-touch panels are equipped with a continuous glass surface.

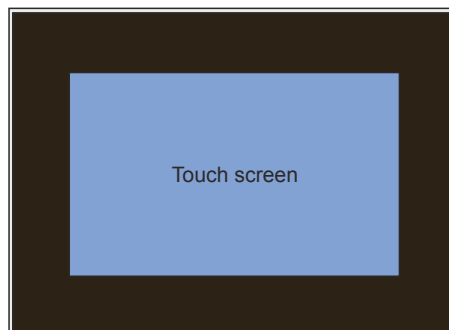

### A.D.1 Autotex panel overlay (polyester)

Unless otherwise specified, the panel overlay is resistant to the following chemicals, materials and substances per DIN 42115 Part 2 when exposed for up to 24 hours without visible changes:

- Acetaldehyde
- Acetone
- Acetonitrile
- Aliphatic hydrocarbons
- Alkali carbonate
- Formic acid <50%
- Ammonia <40%
- Amyl acetate
- Ethanol
- Ether
- Gasoline
- Bichromate
- Potassium
- Cutting oil
- Brake fluid
- Butyl CELLOSOLVE (2-Bu-toxyethanol)
- Sodium hypochlorite <20%
- Cyclohexanol
- Cyclohexanone
- Decon
- Diacetone alcohol
- Dibutyl phthalate
- Diesel
- Diethyl ether
- Diethyl phthalate
- Dioxan
- Dowandol DRM/PM
- Iron II chloride (FeCl<sub>2</sub>)
- Iron III chloride (FeCl<sub>3</sub>)
- Acetic acid <50%
- Butyl acetate
- Ethyl acetate
- Linseed oil
- Aviation fuel
- Formaldehyde 37 to 42%
- Glycerine
- Glycol
- Isophorone
- Isopropanol
- Potassium hydroxide
- Potassium carbonate
- Methanol
- Methylisobutylketone (MIBK)
- Sodium bisulphate
- Sodium carbonate
- Caustic soda <40%
- Paraffin oil
- Phosphoric acid <30%
- Blown castor oil
- Nitric acid <10%
- Hydrochloric acid <36%
- Sea water
- Sulphuric acid <10%
- Silicon oil
- Tenside
- Turpentine oil substitute
- Toluene
- Triacetin
- Trichloroacetic acid < 50%
- Trichloroethane
- Thinner (white spirit)
- Washing agents
- Water
- Hydrogen peroxide <25%
- Fabric conditioner
- Xylene

Per DIN 42115 Part 2, the panel overlay is resistant to exposure to glacial acetic acid for less than one hour without visible damage.

### A.D.2 Aluminum panel overlay

Unless otherwise specified, the panel overlay is resistant to the following chemicals, materials and substances per DIN 42115 Part 2 when exposed for up to 24 hours without visible changes:

- Acetaldehyde
- Acetone
- Acetonitrile
- Alkali carbonate
- Alkane
- Formic acid <50%
- Ammonia <40%
- Amyl acetate
- Gasoline
- Bichromate
- Brake fluid
- Castor oil
- Hydrogen chloride <36%
- Cyclohexanol
- Cyclohexanone
- Decon
- Diacetone alcohol
- Diesel
- Diethyl ether
- Diethyl phthalate
- Dimethylbenzene
- Dioxan
- Dowandol
- DRM/PM
- Iron chloride
- Iron II chloride (FeCl<sub>2</sub>)
- Iron III chloride (FeCl<sub>3</sub>)
- Acetic acid <50%
- Butyl acetate
- Ethanol
- Ether
- Ethyl acetate
- 2-Butoxyethanol (Butyl CEL-  
LOSOVLE)
- Aviation fuel
- Formaldehyde 37 to 42%
- Gear oil
- Glycerine
- Glycol
- Isophorone
- Isopropanol
- Potassium
- Potassium carbonate
- Potassium hydroxide
- White spirit
- Linseed oil
- Methanol
- Methylbenzene
- Methyl ethyl ketone
- Methylisobutylketone
- Sodium bisulphate
- Sodium carbonate
- Sodium hydroxide <40%
- Sodium hypochlorite <20%
- Paraffin oil
- Phosphoric acid <30%
- Phthalate
- Nitric acid <10%
- Sea water
- Cutting oil
- Sulphuric acid <10%
- Turpentine oil replacement
- Triacetin
- Trichloroacetic acid <50%
- Trichloroethane
- Washing agents
- Water
- Hydrogen peroxide <25%
- Fabric conditioner

The panel overlay is not resistant to the following chemicals:

- Benzyl alcohol
- Dimethyl formamide
- Concentrated mineral acid
- Concentrated caustic solution
- High-pressure steam over  
100°C
- Methylene chloride
- Tetrahydrofuran

### A.D.3 Coated aluminum front

Unless otherwise specified, the coated aluminum front is resistant to the following chemicals, materials and substances per DIN 42115 Part 2 when exposed for up to 24 hours without visible changes:

- Formic acid <50%
- Ammonia <40%
- Brake fluid
- Hydrogen chloride <10%
- Diesel
- Acetic acid <50%
- Gear oil
- Lactic acid <10%
- Isopropanol
- Coolant <4%
- Sodium hydroxide <40%
- Petroleum
- Phosphoric acid <25%
- Saline <10%
- Sulphuric acid <25%
- Sidolin
- Skydrol

The coated aluminum front is not resistant to the following chemicals:

- Acetone
- Ethyl acetate

## A.D.4 Touch screen

### 5-wire touch screen (single-touch)

Unless otherwise specified, the touch screen is resistant to the following chemicals, materials and substances when exposed for up to 1 hour (at 25°C) with no visible changes:

- Acetone
- Beer
- Unleaded gasoline
- Chemical cleaning agents
- Hydrogen chloride <6%
- Coca-Cola
- Diesel
- Dimethylbenzene
- Vinegar
- Ethanol
- Antifreeze
- Gear oil
- Ammonia-based glass cleaner
- Household detergents
- Hexane
- n-hexane
- Isopropanol
- Coffee
- Methylbenzene
- Methylene chloride
- Methyl ethyl ketone
- Mineral spirits
- Motor oil
- Nitric acid <70%
- Saline solution <5%
- Tea
- Turpentine
- Lubricants
- Sulphuric acid <40%
- Cooking oil

### Touch screen generation 2 and 3 (multi-touch)

Unless otherwise specified, the touch screen is resistant to the following chemicals, materials and substances per ASTM D 1308-02 and ASTM F 1598-95 when exposed for up to 24 hours without visible changes:

- Acetone
- Ammonia <5%
- Gasoline
- Beer
- Lead
- Brake fluid
- Hydrogen chloride <6%
- Coca-Cola
- Dimethylbenzene
- Ethanol
- Rubber cement
- Isopropanol
- Coffee
- Ink
- Lipstick
- Lysol
- Methylbenzene
- Methyl ethyl ketone
- Naphtha
- Nitric acid <70%
- Lubricants
- Sulphuric acid <40%
- Stamping ink
- Tea
- Trichloroethylene
- Water
- White wine vinegar
- Windex Original

## A.E Touch screen

### A.E.1 5-wire touch screen (single-touch)

#### A.E.1.1 Technical data

##### Information:

The following specified characteristic data, features and limit values are only valid for these individual components and may differ from those of the complete system. The data specified for the complete system applies to the complete system in which an individual component is used.

##### Note:

Drivers for this touch screen for approved operating systems are available for download in the Downloads section of the B&R website ([www.br-automation.com](http://www.br-automation.com)).

| Order number                | Touchscreen 5-Draht   |
|-----------------------------|---|
| <b>General information</b>  |   |
| Technology                  | Analog, resistive   |
| Actuating force             | <1 N  |
| Light transmission          | 80% ±3%   |
| Service life                | 10,000,000 touch operations at the same position (actuating force: 250 g, interval: 0.25 s) |
| <b>Operating conditions</b> |   |
| Activation                  | Finger, stylus, credit card, glove  |
| <b>Ambient conditions</b>   |   |
| Temperature                 |   |
| Operation                   | -20 to 70°C   |
| Storage                     | -40 to 80°C   |
| Transport                   | -40 to 80°C   |
| Relative humidity           |   |
| Operation                   | 90% at max. 50°C  |
| Storage                     | 90% RH at max. 60°C for 504 hours   |
| Transport                   | 90% RH at max. 60°C for 504 hours   |

#### A.E.1.2 Temperature/Humidity diagram

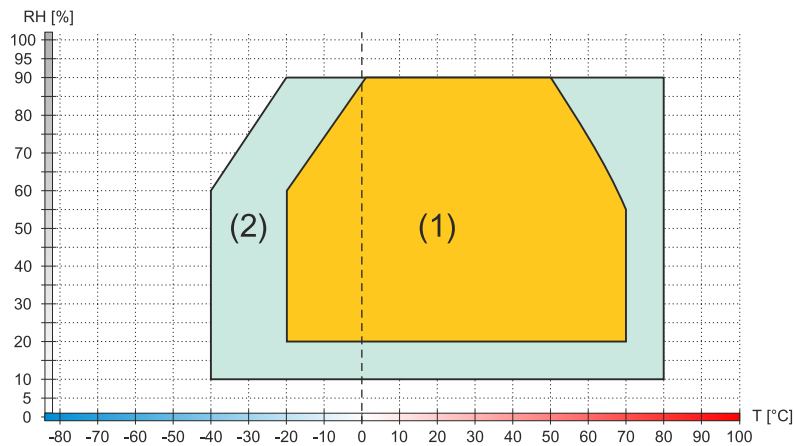

| Diagram legend |                       |        |   |
|----------------|-----------------------|--------|---|
| (1)            | Operation             | T [°C] | Temperature in °C   |
| (2)            | Storage and transport | RH [%] | Relative humidity (RH) in percent and <b>non-condensing</b> |

## A.E.2 Touch screen (multi-touch generation 2)

### A.E.2.1 General information

Valid for the following products:

- 5AP933.156B-00 with Rev. ≤ C0
- 5AP933.185B-00 with Rev. ≤ C0
- 5AP933.215C-00 with Rev. ≤ C0
- 5AP933.240C-00 with Rev. ≤ C0

### A.E.2.2 Technical data

#### Information:

The following specified characteristic data, features and limit values are only valid for these individual components and may differ from those of the complete system. The data specified for the complete system applies to the complete system in which an individual component is used.

| Order number                | Touchscreen                      |
|-----------------------------|----------------------------------|
| <b>General information</b>  |                                  |
| Technology                  | Projected capacitive touch (PCT) |
| Light transmission          | 88 ±2%                           |
| Anti-glare coating          | Optical/Gloss = 70               |
| <b>Operating conditions</b> |                                  |
| Activation                  | Finger, thin glove               |
| <b>Ambient conditions</b>   |                                  |
| Temperature                 |                                  |
| Operation                   | 0 to 50°C                        |
| Storage                     | -10 to 70°C                      |
| Transport                   | -10 to 70°C                      |
| Relative humidity           |                                  |
| Operation                   | 90% at max. 35°C                 |
| Storage                     | 90% at max. 35°C                 |
| Transport                   | 90% at max. 35°C                 |

### A.E.2.3 Temperature/Humidity diagram

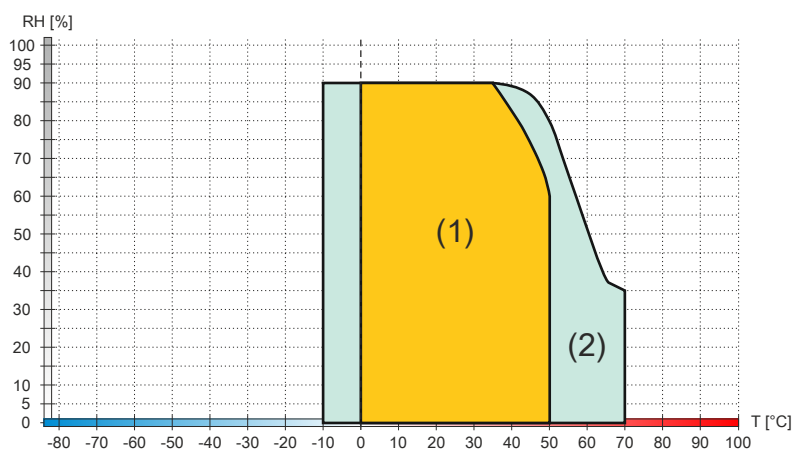

| Diagram legend |                       |        |   |
|----------------|-----------------------|--------|---|
| (1)            | Operation             | T [°C] | Temperature in °C   |
| (2)            | Storage and transport | RH [%] | Relative humidity (RH) in percent and <b>non-condensing</b> |

### A.E.3 Touch screen (multi-touch generation 3)

#### A.E.3.1 General information

Valid for the following products:

- 5AP1130.0702-000
- 5AP1130.101x-000
- 5AP1130.121E-0x0
- 5AP1130.156C-00x
- 5AP1130.185C-000
- 5AP933.156B-00 with Rev.  $\geq$  D0
- 5AP933.185B-00 with Rev.  $\geq$  D0
- 5AP933.215C-00 with Rev.  $\geq$  D0
- 5AP933.240C-00 with Rev.  $\geq$  D0

#### A.E.3.2 Technical data

##### Information:

The following specified characteristic data, features and limit values are only valid for these individual components and may differ from those of the complete system. The data specified for the complete system applies to the complete system in which an individual component is used.

| Order number                | Touchscreen                                     |
|-----------------------------|---|
| <b>General information</b>  |   |
| Technology                  | Projected capacitive touch (PCT)                |
| Light transmission          | >90%  |
| Anti-glare coating          | Optical/Gloss = 80                              |
| <b>Operating conditions</b> |   |
| Activation                  | Finger, thin glove                              |
| <b>Ambient conditions</b>   |   |
| Temperature                 |   |
| Operation                   | -10 to 70°C                                     |
| Storage                     | -40 to 70°C                                     |
| Transport                   | -40 to 70°C                                     |
| Relative humidity           |   |
| Operation                   | Up to 90% at max. 35°C, see diagram for > 35°C. |
| Storage                     | Up to 90% at max. 35°C, see diagram for > 35°C. |
| Transport                   | Up to 90% at max. 35°C, see diagram for > 35°C. |

#### A.E.3.3 Temperature/Humidity diagram

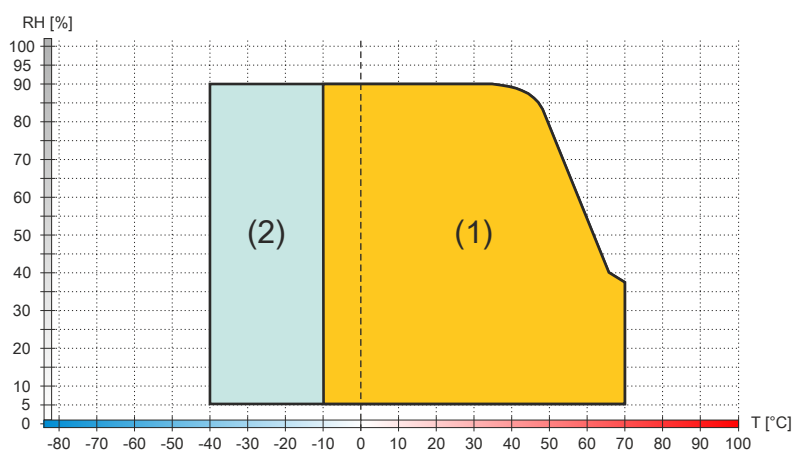

| Diagram legend |                       |        |   |
|----------------|-----------------------|--------|---|
| (1)            | Operation             | T [°C] | Temperature in °C   |
| (2)            | Storage and transport | RH [%] | Relative humidity (RH) in percent and <b>non-condensing</b> |

## A.F Cable data

| Signal |   | Signal |   |
|--------|---|--------|---|
| RS232  | "RS232 - Bus length and cable type" on page 285 | RS422  | "RS422 - Bus length and cable type" on page 285 |
| RS485  | "RS485 - Bus length and cable type" on page 286 | CAN    | "CAN - Bus length and cable type" on page 286   |

### A.F.1 RS232 - Bus length and cable type

The maximum transfer rate of 115 kbit/s depends on the cable length and type of cable used.

| Bus length | Transfer rate   |
|------------|-----------------|
| ≤15 m      | Typ. 64 kbit/s  |
| ≤10 m      | Typ. 115 kbit/s |
| ≤5 m       | Typ. 115 kbit/s |

Preferably, the cable material used should have the following properties or deviate only slightly from them in order to achieve an optimal transfer rate.

| RS232 cables         | Property  |
|----------------------|---|
| <b>Signal line</b>   |   |
| Cable cross section  | 4x 0.16 mm <sup>2</sup> (26 AWG), tinned copper stranded wire   |
| Wire insulation      | PE  |
| Conductor resistance | ≤82 Ω/km  |
| Stranding            | Twisted-pair wires  |
| Shield               | Pair shielding with aluminum foil                               |
| <b>GND</b>           |   |
| Cable cross section  | 1x 0.34 mm <sup>2</sup> (22AWG/19), tinned copper stranded wire |
| Wire insulation      | PE  |
| Conductor resistance | ≤59 Ω/km  |
| <b>Outer jacket</b>  |   |
| Material             | PUR compound  |
| Properties           | Halogen-free  |
| Cable shield         | Tinned copper wire  |

### A.F.2 RS422 - Bus length and cable type

The RTS line must be switched on to activate the transmitter.

The maximum transfer rate of 115 kbit/s depends on the cable length and type of cable used.

| Bus length | Transfer rate   |
|------------|-----------------|
| 1200 m     | Typ. 115 kbit/s |

Preferably, the cable material used should have the following properties or deviate only slightly from them in order to achieve an optimal transfer rate.

| RS422 cables         | Property  |
|----------------------|---|
| <b>Signal line</b>   |   |
| Cable cross section  | 4x 0.25 mm <sup>2</sup> (24AWG/19), tinned copper stranded wire |
| Wire insulation      | PE  |
| Conductor resistance | ≤82 Ω/km  |
| Stranding            | Twisted-pair wires  |
| Shield               | Pair shielding with aluminum foil                               |
| <b>GND</b>           |   |
| Cable cross section  | 1x 0.34 mm <sup>2</sup> (22AWG/19), tinned copper stranded wire |
| Wire insulation      | PE  |
| Conductor resistance | ≤59 Ω/km  |
| <b>Outer jacket</b>  |   |
| Material             | PUR compound  |
| Properties           | Halogen-free  |
| Cable shield         | Tinned copper wire  |

### A.F.3 RS485 - Bus length and cable type

The maximum transfer rate of 115 kbit/s depends on the cable length and type of cable used.

| Bus length | Transfer rate   |
|------------|-----------------|
| 1200 m     | Typ. 115 kbit/s |

Preferably, the cable material used should have the following properties or deviate only slightly from them in order to achieve an optimal transfer rate.

| RS485 cables         |   | Property |
|----------------------|---|----------|
| <b>Signal line</b>   |   |          |
| Cable cross section  | 4x 0.25 mm <sup>2</sup> (24AWG/19), tinned copper stranded wire |          |
| Wire insulation      | PE  |          |
| Conductor resistance | ≤82 Ω/km  |          |
| Stranding            | Twisted-pair wires  |          |
| Shield               | Pair shielding with aluminum foil                               |          |
| <b>GND</b>           |   |          |
| Cable cross section  | 1x 0.34 mm <sup>2</sup> (22AWG/19), tinned copper stranded wire |          |
| Wire insulation      | PE  |          |
| Conductor resistance | ≤59 Ω/km  |          |
| <b>Outer jacket</b>  |   |          |
| Material             | PUR compound  |          |
| Properties           | Halogen-free  |          |
| Cable shield         | Tinned copper wire  |          |

### A.F.4 CAN - Bus length and cable type

The type of cable to be used depends largely on the required bus length and number of nodes. The bus length is determined by the transfer rate. Per CiA (CAN in Automation), the maximum bus length is 1000 meters.

The following bus lengths are permitted at a maximum permissible oscillator tolerance of 0.121%:

| Bus length <sup>1)</sup> | Transfer rate   |
|--------------------------|-----------------|
| ≤1000 m                  | Typ. 50 kbit/s  |
| ≤200 m                   | Typ. 250 kbit/s |
| ≤100 m                   | Typ. 500 kbit/s |
| ≤20 m <sup>2)</sup>      | Typ. 1 Mbit/s   |
| ≤15 m <sup>3)</sup>      |                 |

- 1) The specified cable length is only valid with the values specified in "CAN driver settings". Cable lengths otherwise depend on the values in the bit timing register, cable quality and number of nodes.
- 2) For CAN interfaces without galvanic isolation and 5ACCIF01.ICAN-000.
- 3) For CAN interfaces with galvanic isolation.

Preferably, the cable material used should have the following properties or deviate only slightly from them in order to achieve an optimal transfer rate.

| CAN cable            |   | Property |
|----------------------|---|----------|
| <b>Signal line</b>   |   |          |
| Cable cross section  | 2x 0.25 mm <sup>2</sup> (24AWG/19), tinned copper stranded wire |          |
| Wire insulation      | PE  |          |
| Conductor resistance | ≤82 Ω/km  |          |
| Stranding            | Twisted-pair wires  |          |
| Shield               | Pair shielding with aluminum foil                               |          |
| <b>GND</b>           |   |          |
| Cable cross section  | 1x 0.34 mm <sup>2</sup> (22AWG/19), tinned copper stranded wire |          |
| Wire insulation      | PE  |          |
| Conductor resistance | ≤59 Ω/km  |          |
| <b>Outer jacket</b>  |   |          |
| Material             | PUR compound  |          |
| Properties           | Halogen-free  |          |
| Cable shield         | Tinned copper wire  |          |

## A.G POWERLINK

### A.G.1 LED "S/E" (status/error LED)

This LED is a green/red dual LED and indicates the state of the POWERLINK interface. The LED states have a different meaning depending on the operating mode of the POWERLINK interface.

#### A.G.1.1 Ethernet mode

In this mode, the interface is operated as an Ethernet interface.

| LED "S/E" |     | Description   |
|-----------|-----|---|
| Green     | Red |   |
| On        | Off | The interface is operated as an Ethernet interface. |

Table: LED "S/E": Interface in Ethernet mode

#### A.G.1.2 POWERLINK V2 mode

##### Error message

| LED "S/E" |     | Description   |
|-----------|-----|---|
| Green     | Red |   |
| Off       | On  | The interface is in error mode (failed Ethernet frames, increased number of collisions on the network, etc.).<br>Note:<br>Several red blinking signals are displayed immediately after the device is switched on. These are not errors, however.  |
| Blinking  | On  | If an error occurs in the following modes, then the green LED blinks over the red LED: <ul style="list-style-type: none"> <li>PRE_OPERATIONAL_1</li> <li>PRE_OPERATIONAL_2</li> <li>READY_TO_OPERATE</li> </ul>  |

Table: LED "S/E" - Error message (interface in POWERLINK mode)

##### Interface status

| LED "S/E"                  |     | Description   |
|----------------------------|-----|---|
| Green                      | Red |   |
| Off                        | Off | <b>Mode: NOT_ACTIVE</b><br>The interface is either in mode NOT_ACTIVE or one of the following modes or errors is present: <ul style="list-style-type: none"> <li>The device is switched off.</li> <li>The device is in the startup phase.</li> <li>The interface or device is not configured correctly in Automation Studio.</li> <li>The interface or device is defective.</li> </ul><br><b>Managing node (MN)</b><br>The network is monitored for POWERLINK frames. If a frame is not received within the configured time window (timeout), the interface immediately enters mode PRE_OPERATIONAL_1.<br>If POWERLINK communication is detected before the time has elapsed, however, the MN is not started. |
| Flickering (approx. 10 Hz) | Off | <b>Mode: BASIC_ETHERNET</b><br>The interface is in mode BASIC_ETHERNET. The interface is operated in <a href="#">Ethernet mode</a> .<br><br><b>Managing node (MN)</b><br>This mode can only be exited by resetting the controller.<br><br><b>Controlled node (CN)</b><br>If POWERLINK communication is detected during this mode, the interface enters mode PRE_OPERATIONAL_1.  |

Table: LED "S/E" - Interface state (interface in POWERLINK mode)

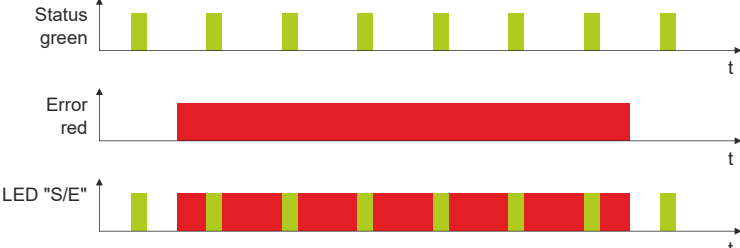
| LED "S/E"                      |     | Description   |
|--------------------------------|-----|---|
| Green                          | Red |   |
| Single flash<br>(approx. 1 Hz) | Off | <p><b>Mode:</b> PRE_OPERATIONAL_1<br/>The interface is in mode PRE_OPERATIONAL_1.</p> <p><b>Managing node (MN)</b><br/>The MN is in "reduced cycle" mode. The CNs are configured in this mode. Cyclic communication is not yet taking place.</p> <p><b>Controlled node (CN)</b><br/>The CN can be configured by the MN in this mode. The CN waits until it receives an SoC frame and then switches to mode PRE_OPERATIONAL_2.</p> |
|                                | On  | <p><b>Controlled node (CN)</b><br/>If the red LED lights up in this mode, this means that the MN has failed.</p>  |
| Double flash<br>(approx. 1 Hz) | Off | <p><b>Mode:</b> PRE_OPERATIONAL_2<br/>The interface is in mode PRE_OPERATIONAL_2.</p> <p><b>Managing node (MN)</b><br/>The MN starts cyclic communication (cyclic input data is not yet evaluated). The CNs are configured in this mode.</p> <p><b>Controlled node (CN)</b><br/>The CN can be configured by the MN in this mode. A command then switches the mode to READY_TO_OPERATE.</p>  |
|                                | On  | <p><b>Controlled node (CN)</b><br/>If the red LED lights up in this mode, this means that the MN has failed.</p>  |
| Triple flash<br>(approx. 1 Hz) | Off | <p><b>Mode:</b> READY_TO_OPERATE<br/>The interface is in mode READY_TO_OPERATE.</p> <p><b>Managing node (MN)</b><br/>Cyclic and asynchronous communication. Received PDO data is ignored.</p> <p><b>Controlled node (CN)</b><br/>The configuration of the CN is completed. Normal cyclic and asynchronous communication. The transmitted PDO data corresponds to the PDO mapping. However, cyclic data is not yet evaluated.</p>  |
|                                | On  | <p><b>Controlled node (CN)</b><br/>If the red LED lights up in this mode, this means that the MN has failed.</p>  |
| On                             | Off | <p><b>Mode:</b> OPERATIONAL<br/>The interface is in mode OPERATIONAL. PDO mapping is active and cyclic data is evaluated.</p>   |
| Blinking<br>(approx. 2.5 Hz)   | Off | <p><b>Mode:</b> STOPPED<br/>The interface is in mode STOPPED.</p> <p><b>Managing node (MN)</b><br/>This mode does not occur for the MN.</p> <p><b>Controlled node (CN)</b><br/>Output data is not being output, and no input data is being provided. This mode can only be reached and exited by a corresponding command from the MN.</p>   |

Table: LED "S/E" - Interface state (interface in POWERLINK mode)

**Blink times**

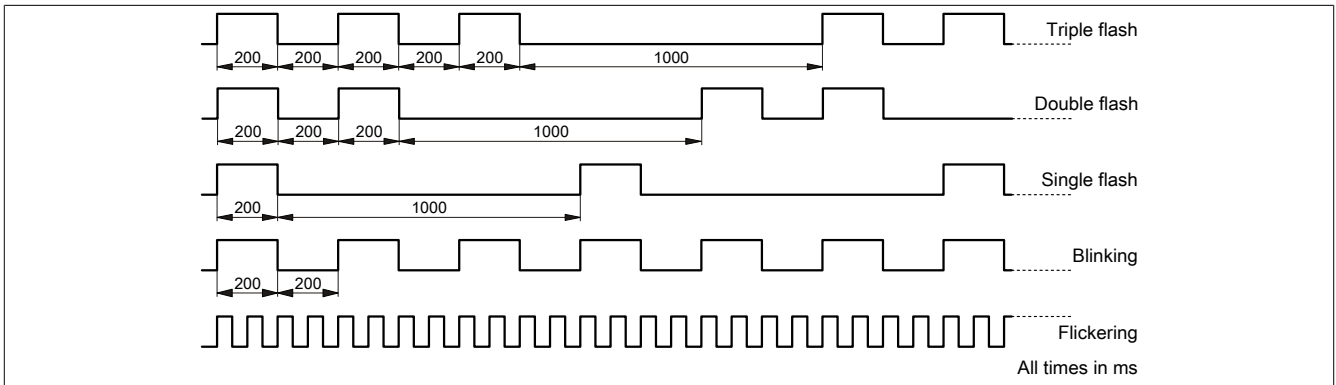

### A.G.1.3 System stop error codes

A system stop error can occur due to incorrect configuration or defective hardware.

The error code is indicated by LED "S/E" blinking red. The blinking signal of the error code consists of 4 switch-on phases with short (150 ms) or long (600 ms) duration. The error code is repeated every 2 seconds.

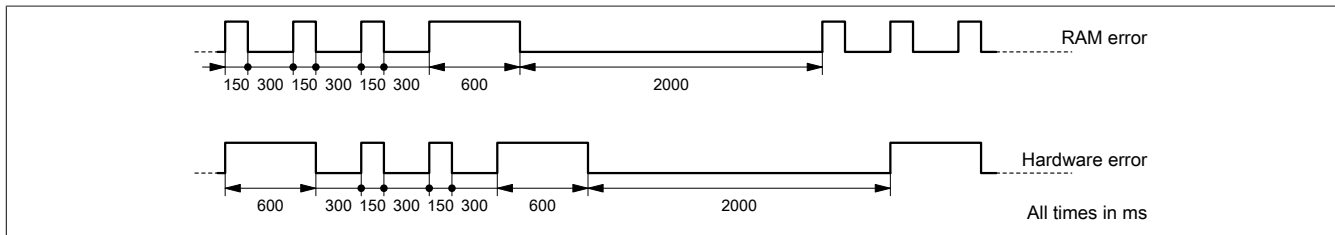

| Error          | Error description   |
|----------------|---|
| RAM error      | The device is defective and must be replaced.                       |
| Hardware error | The device or a system component is defective and must be replaced. |

### A.G.1.4 POWERLINK V2

By default, the POWERLINK interface is operated as a managing node (MN). In the managing node, the node number is set to a fixed value of 240.

If the POWERLINK node is operated as a controlled node (CN), a node number from 1 to 239 can be set in the POWERLINK configuration in Automation Studio.

## A.H Installation compatibility

This section describes the compatibility of the installation dimensions for Power Panel 100/200, Power Panel 300/400, Power Panel 500, Automation Panel 900, Automation Panel 1000, Panel PC 700 and Panel PC 800 devices depending on the respective device diagonals.

The external dimensions of the device types of the respective diagonals are identical.

### Information:

Device designation "AP1000" refers to the Automation Panel 1000 as well as to the Panel PC 900, Panel PC 2100, Panel PC 2200 and Panel PC 3100 with an installed AP1000 panel.

The various device types are abbreviated as follows:

| Device type           | Short form |
|-----------------------|------------|
| Power Panel xxx       | PPxxx      |
| Panel PC xxxx         | PPCxxxx    |
| Automation Panel xxxx | APxxxx     |

### A.H.1 Compatibility overview

The following table gives a brief overview of the PP100/200, PP300/400, PP500, AP900, AP1000, PPC700 and PPC800 devices. For more information, see section "Compatibility details" on page 292.

### Information:

The cutout tolerance for the PP100/200, PP300/400, PP500, AP900, PPC700 and PPC800 is  $\pm 0.5$  mm.  
The cutout tolerance for the AP1000 is +0 mm / -0.5 mm.

| Diagonal | Format      |                         | PP100/200   | PP300/400 | PP500     | AP900     | AP1000 <sup>1)</sup> | PPC700 | PPC800 |
|----------|-------------|-------------------------|-------------|-----------|-----------|-----------|----------------------|--------|--------|
| 5.7"     | Land-scape1 | Outer dimensions        | 212 x 156   |           | -         | 212 x 156 | -                    |        |        |
|          |             | Installation dimensions | 199 x 143   |           | -         | 199 x 143 | -                    |        |        |
|          | Land-scape2 | Outer dimensions        | 302 x 187   |           | -         | -         |                      |        |        |
|          |             | Installation dimensions | 289 x 174   |           | -         | -         |                      |        |        |
|          | Por-trait1  | Outer dimensions        | 212 x 245   |           | -         | 212 x 245 | -                    |        |        |
|          |             | Installation dimensions | 199 x 226.8 | 199 x 232 | -         | 199 x 232 | -                    |        |        |
| 7"       | Land-scape1 | Outer dimensions        | -           | 212 x 156 | -         | 212 x 156 | -                    |        |        |
|          |             | Installation dimensions | -           | 199 x 143 | -         | 199 x 143 | -                    |        |        |
| 10.4"    | Land-scape1 | Outer dimensions        | 323 x 260   |           |           |           | -                    |        |        |
|          |             | Installation dimensions | 303 x 243   |           |           |           | -                    |        |        |
|          | Land-scape2 | Outer dimensions        | 423 x 288   |           |           |           | -                    |        |        |
|          |             | Installation dimensions | 402 x 266.5 | 403 x 271 | 402 x 271 | 403 x 271 | 402 x 271            | -      |        |
|          | Por-trait1  | Outer dimensions        | 323 x 358   |           |           |           | -                    |        |        |
|          |             | Installation dimensions | 303 x 336   | 303 x 341 |           |           | -                    |        |        |
| 12.1"    | Land-scape1 | Outer dimensions        | 362 x 284   |           |           |           | -                    |        |        |
|          |             | Installation dimensions | 345 x 267   | 342 x 267 |           |           | -                    |        |        |

| Diagonal | Format          |                            | PP100/200 | PP300/400 | PP500     | AP900     | AP1000 <sup>1)</sup> | PPC700    | PPC800    |   |
|----------|-----------------|----------------------------|-----------|-----------|-----------|-----------|----------------------|-----------|-----------|---|
| 15"      | Land-<br>scape1 | Outer di-<br>mensions      | 435 x 330 |           |           |           |                      |           |           |   |
|          |                 | Installation<br>dimensions | 415 x 312 |           | 415 x 313 | 415 x 312 | 415 x 313            | 415 x 312 |           |   |
|          | Por-<br>trait1  | Outer di-<br>mensions      | 435 x 430 |           |           |           |                      | -         | 435 x 430 | - |
|          |                 | Installation<br>dimensions | 415 x 412 |           | 415 x 413 | 415 x 412 |                      | -         | 415 x 412 | - |
| 17"      | Land-<br>scape1 | Outer di-<br>mensions      | -         |           |           | 477 x 390 | -                    | 477 x 390 | -         |   |
|          |                 | Installation<br>dimensions | -         |           |           | 460 x 373 | -                    | 460 x 373 | -         |   |
| 19"      | Land-<br>scape1 | Outer di-<br>mensions      | -         |           |           | 527 x 421 |                      |           |           |   |
|          |                 | Installation<br>dimensions | -         |           |           | 510 x 404 |                      |           |           |   |
| 21.3"    | Land-<br>scape1 | Outer di-<br>mensions      | -         |           |           | 583 x 464 | -                    |           |           |   |
|          |                 | Installation<br>dimensions | -         |           |           | 566 x 447 | -                    |           |           |   |

1) Device designation "AP1000" refers to the Automation Panel 1000 as well as to Panel PCs installed on AP1000 panels.

## A.H.2 Compatibility details

### A.H.2.1 Example

The dimensions (mm) in the subsequent figures have the following meaning.

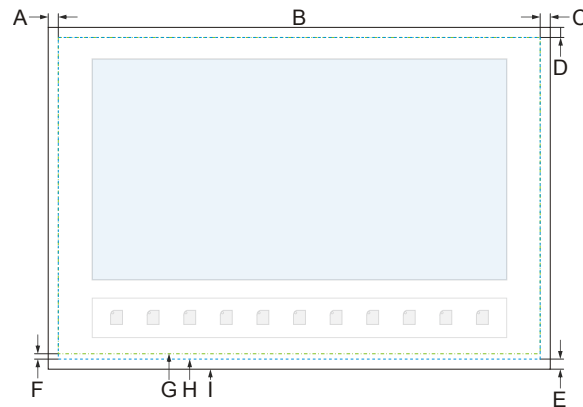

| Diagram legend |                                 |   |   |
|----------------|---------------------------------|---|---|
| A              | Spacing (left) to device edge   | F | Difference value  |
| B              | Outer dimensions                | G | Installation dimensions/Cutout for PP100/200/300/400 device |
| C              | Spacing (right) to device edge  | H | Installation dimensions/Cutout AP900/PP500/PPC700 device    |
| D              | Spacing (top) to device edge    | I | Outer contour of device                                     |
| E              | Spacing (bottom) to device edge |   |   |

### A.H.2.2 5.7" devices

The cutout tolerance for the PP100/200, PP300/400, PP500, AP900, PPC700 and PPC800 is  $\pm 0.5$  mm. The cutout tolerance for the AP1000 is  $+0$  mm /  $-0.5$  mm.

#### Installation compatibility - 5.7" devices - Landscape1

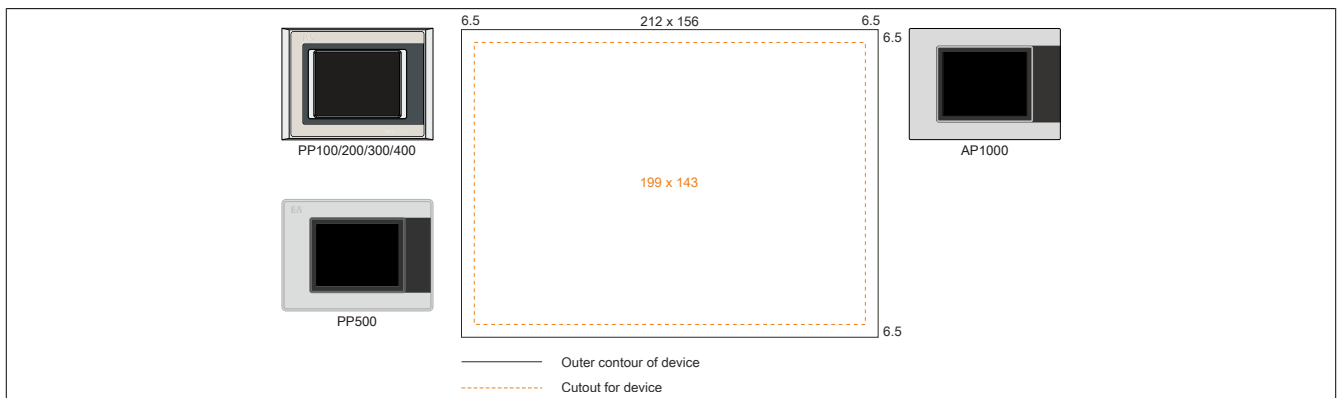

The 5.7" Automation Panel 1000, Power Panel 500, Power Panel 300/400 and Power Panel 100/200 devices in Landscape1 format are 100% compatible.

#### Installation compatibility - 5.7" devices - Landscape2

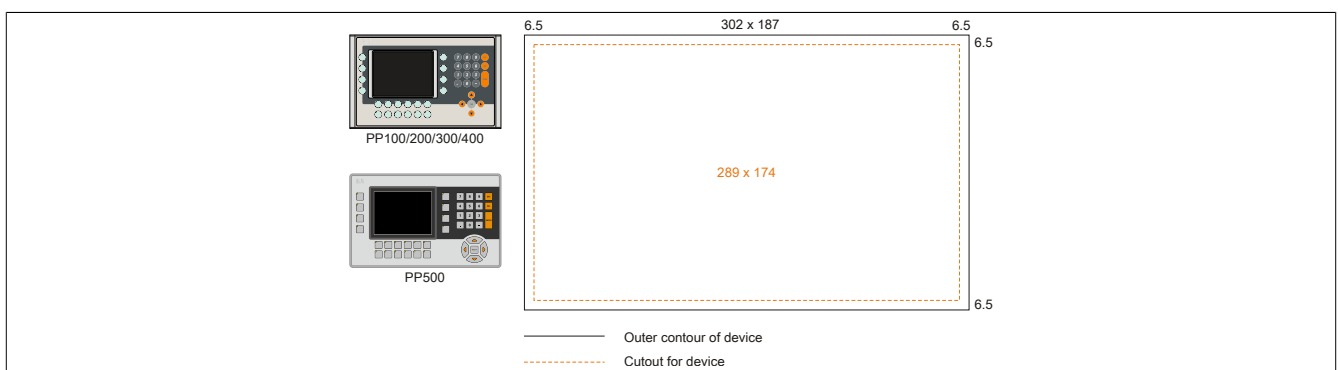

The 5.7" Power Panel 500, Power Panel 300/400 and Power Panel 100/200 devices in Landscape2 format are 100% compatible.

## Installation compatibility - 5.7" devices - Portrait1

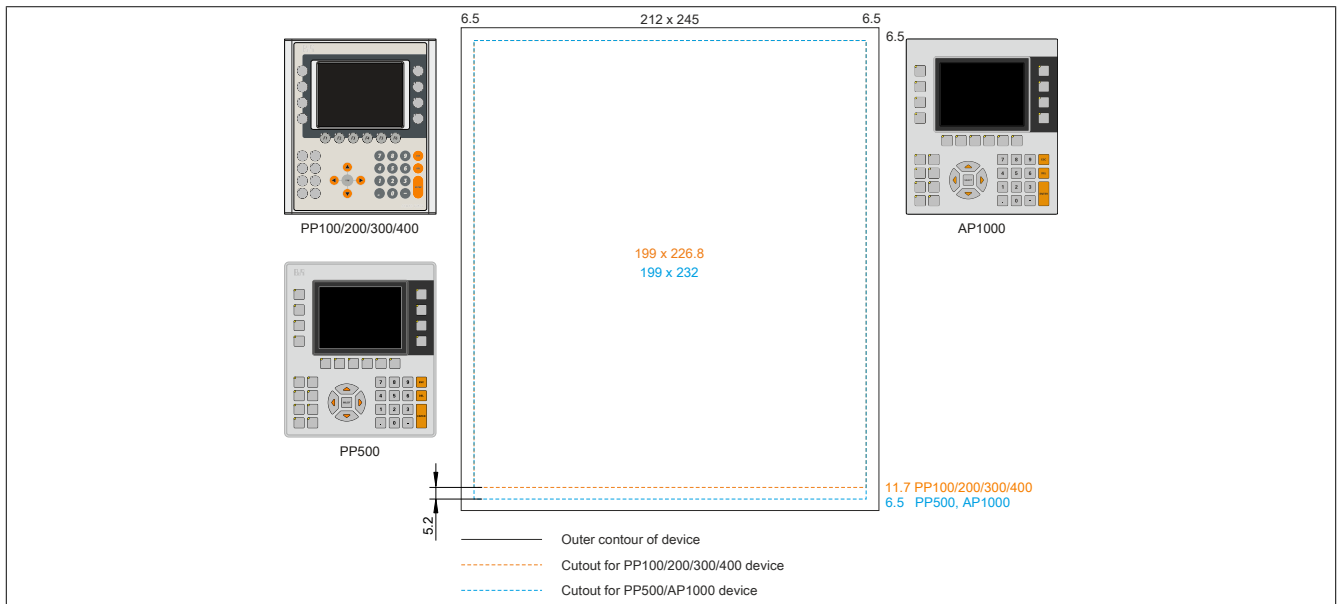

The 5.7" Automation Panel 1000 and Power Panel 500 are not 100% compatible with Power Panel 300/400 and Power Panel 100/200 devices in Portrait1 format. Automation Panel 1000 and Power Panel 500 devices need a cutout that is 5.2 mm larger (bottom edge).

### The larger cutout can be used conditionally for all devices:

- During installation, it is important to ensure that the PP100/200 and PP300/400 devices are positioned and installed as centrally as possible in the cutout. If this is not the case, the retaining clips can no longer grip and impermeability is no longer ensured by the circumferential cord gasket (IP65).

### A.H.2.3 10.4" devices

The cutout tolerance for the PP100/200, PP300/400, PP500, AP900, PPC700 and PPC800 is  $\pm 0.5$  mm. The cutout tolerance for the AP1000 is  $+0$  mm /  $-0.5$  mm.

#### Installation compatibility - 10.4" devices - Landscape1

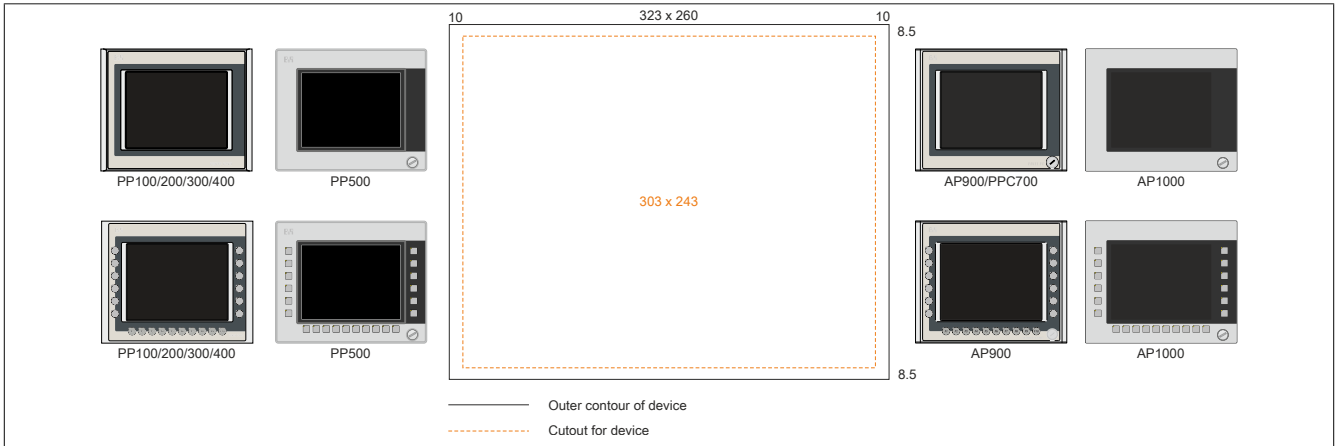

10.4" Automation Panel 1000, Automation Panel 900, Panel PC 700, Power Panel 500, Power Panel 300/400 and Power Panel 100/200 devices in Landscape1 format are 100% compatible.

#### Installation compatibility - 10.4" devices - Landscape2

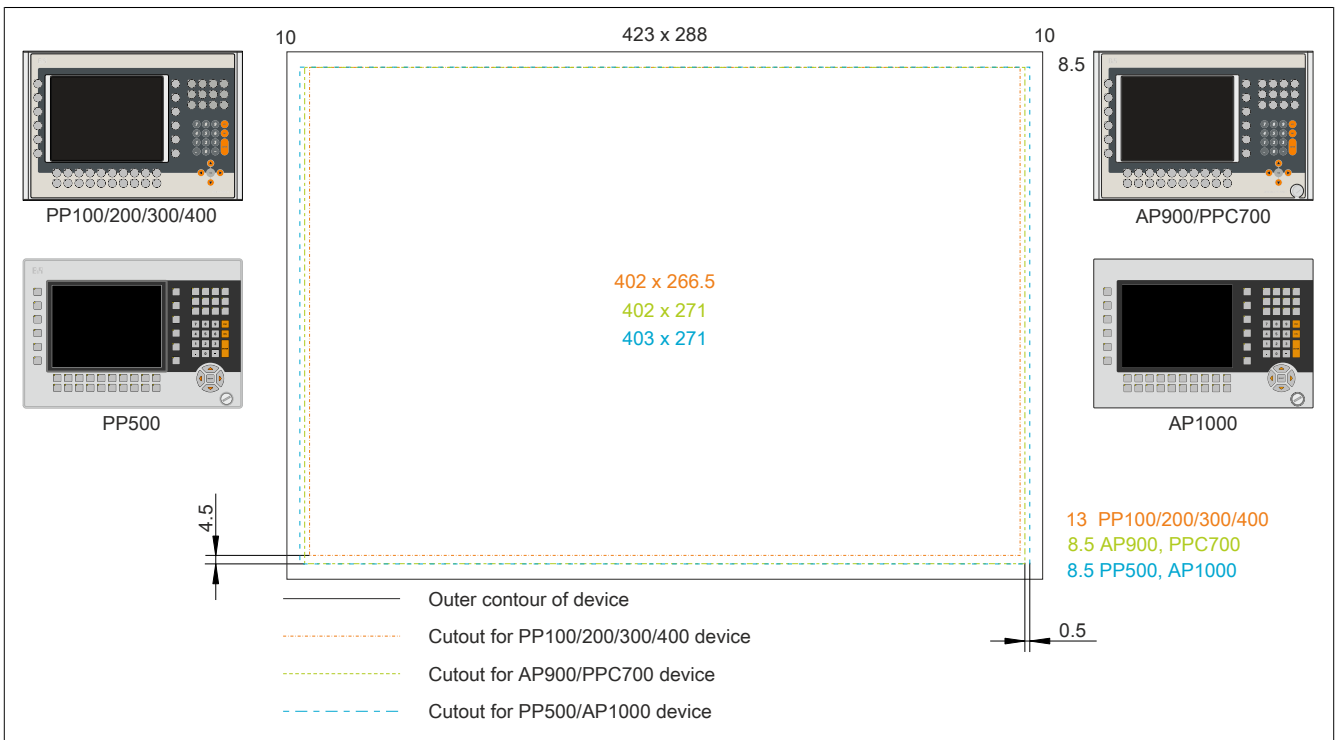

10.4" Automation Panel 1000, Automation Panel 900, Panel PC 700 and Power Panel 500 devices are not 100% compatible with Power Panel 300/400 or Power Panel 100/200 devices in Landscape2 format. Automation Panel 1000, Automation Panel 900, Panel PC 700 and Power Panel 500 devices need a cutout that is 4.5 mm larger (bottom edge) and 0.5 mm wider (left and right).

#### The larger cutout can be used conditionally for all devices:

- During installation, it is important to ensure that the PP100/200 and PP300/400 devices are positioned and installed as centrally as possible in the cutout. If this is not the case, the retaining clips can no longer grip and impermeability is no longer ensured by the circumferential cord gasket (IP65).

## Installation compatibility - 10.4" devices - Portrait1

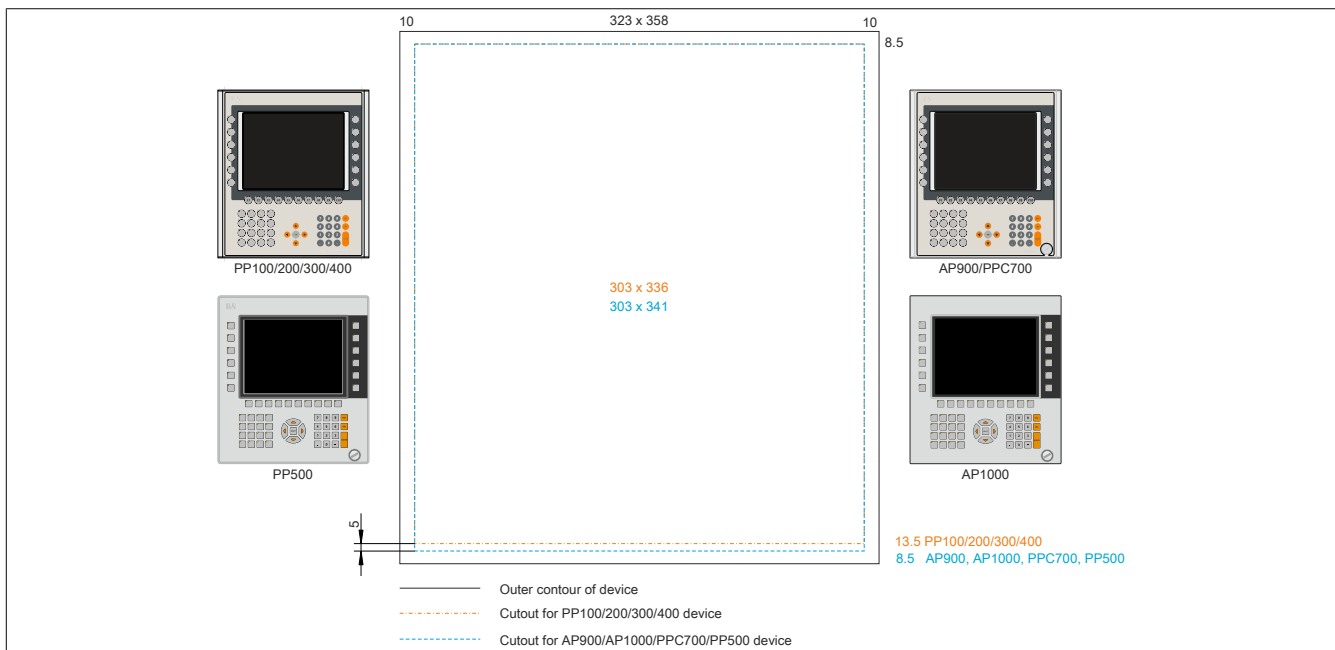

Figure 1: Installation compatibility - 10.4" devices - Portrait1

10.4" Automation Panel 1000, Automation Panel 900, Panel PC 700 and Power Panel 500 devices are not 100% compatible with Power Panel 300/400 or Power Panel 100/200 devices in Portrait1 format. Automation Panel 1000, Automation Panel 900, Panel PC 700 and Power Panel 500 devices need a cutout that is 5 mm larger (bottom edge).

### The larger cutout can be used conditionally for all devices:

- During installation, it is important to ensure that the PP100/200/300/400 devices are positioned and installed as centrally as possible in the cutout. If this is not the case, the retaining clips can no longer grip and impermeability is no longer ensured by the circumferential cord gasket (IP65).

### A.H.2.4 12.1" devices

The cutout tolerance for the PP100/200, PP300/400, PP500, AP900, PPC700 and PPC800 is  $\pm 0.5$  mm.  
The cutout tolerance for the AP1000 is +0 mm / -0.5 mm.

#### Installation compatibility - 12.1" devices - Landscape1

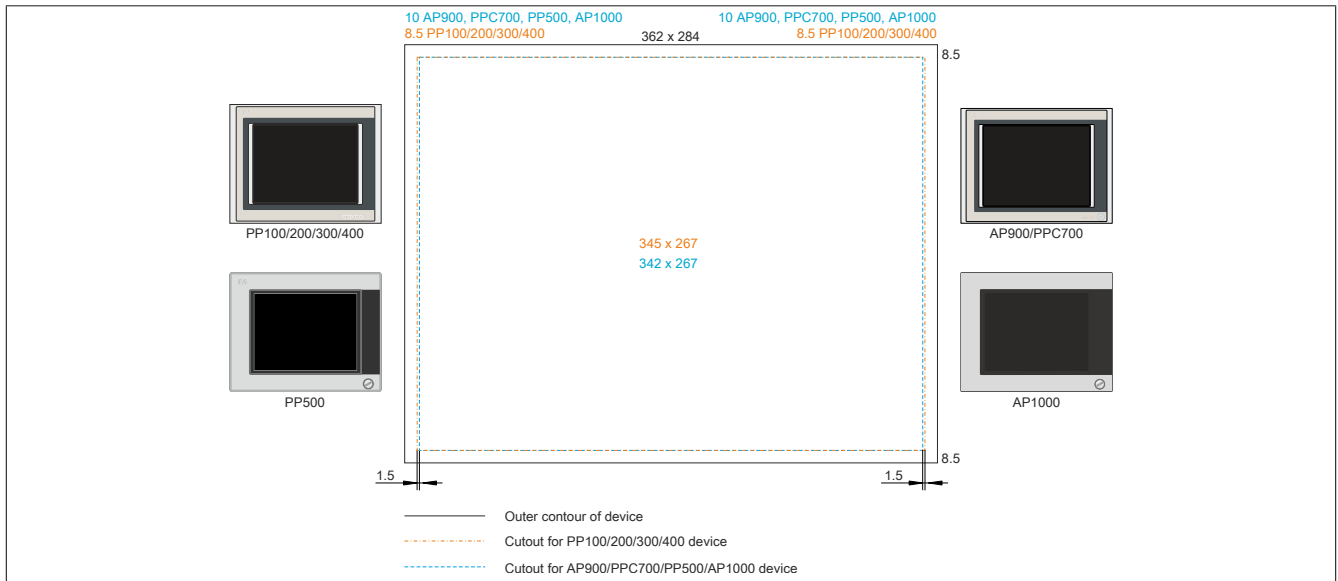

12.1" Automation Panel 1000, Automation Panel 900, Panel PC 700 and Power Panel 500 devices are not 100% compatible with Power Panel 300/400 or Power Panel 100/200 devices in Landscape1 format. Power Panel 300/400 and Power Panel 100/200 devices need a cutout that is 1.5 mm wider (left and right).

#### The larger cutout can be used conditionally for all devices:

- During installation, it is important to ensure that the AP1000, AP900, PPC700 and PP500 devices are positioned and installed as centrally as possible in the cutout.

### A.H.2.5 15" devices

The cutout tolerance for the PP100/200, PP300/400, PP500, AP900, PPC700 and PPC800 is  $\pm 0.5$  mm. The cutout tolerance for the AP1000 is  $+0$  mm /  $-0.5$  mm.

#### Installation compatibility - 15" devices - Landscape1

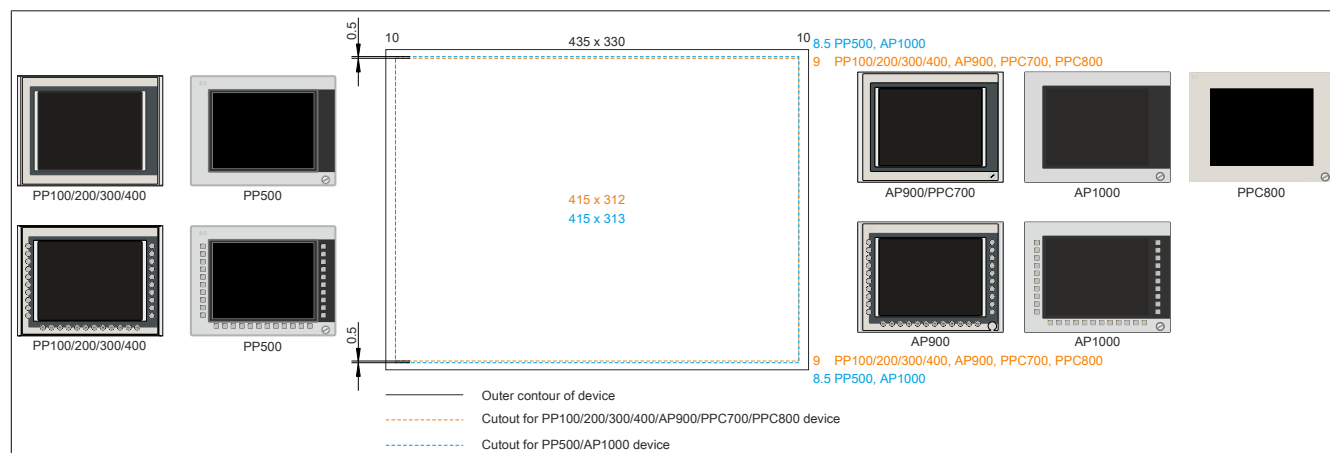

15" Automation Panel 1000 and Power Panel 500 devices are not 100% compatible with Power Panel 100/200, Power Panel 300/400, Automation Panel 900, Panel PC 700 and Panel PC 800 devices in Landscape1 format. Automation Panel 1000 and Power Panel 500 devices need a cutout that is 0.5 mm larger (top and bottom edge).

#### The larger cutout can be used conditionally for all devices:

- During installation, it is important to ensure that the PP100/200, PP300/400, AP900, PPC700 and PPC800 devices are positioned and installed as centrally as possible in the cutout. If this is not the case, the retaining clips can no longer grip and impermeability is no longer ensured by the circumferential cord gasket (IP65).

#### Installation compatibility - 15" devices - Portrait1

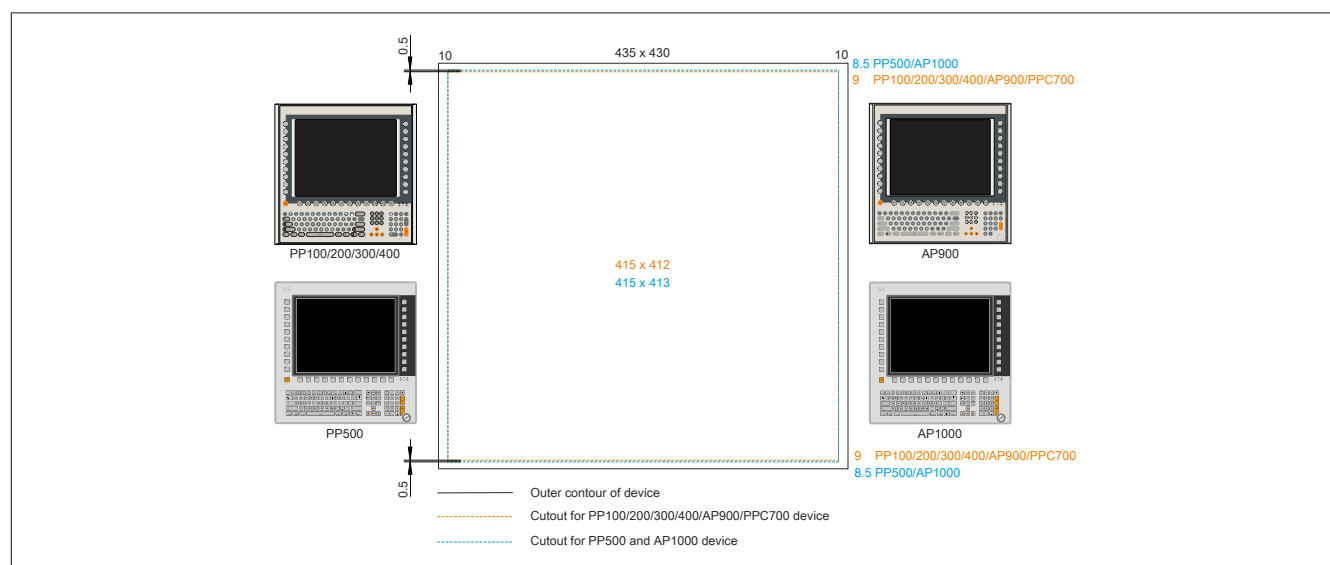

15" Automation Panel 1000 and Power Panel 500 devices are not 100% compatible with Power Panel 100/200, Power Panel 300/400, Automation Panel 900 and Panel PC 700 devices in Portrait1 format. Automation Panel 1000 and Power Panel 500 devices need a cutout that is 0.5 mm larger (top and bottom edge).

#### The larger cutout can be used conditionally for all devices:

- During installation, it is important to ensure that the PP100/200, PP300/400, AP900 and PPC700 devices are positioned and installed as centrally as possible in the cutout. If this is not the case, the retaining clips can no longer grip and impermeability is no longer ensured by the circumferential cord gasket (IP65).

**A.H.2.6 17" devices**

The cutout tolerance for the PP100/200, PP300/400, PP500, AP900, PPC700 and PPC800 is  $\pm 0.5$  mm.  
 The cutout tolerance for the AP1000 is +0 mm / -0.5 mm.

**Installation compatibility - 17" devices - Landscape1**

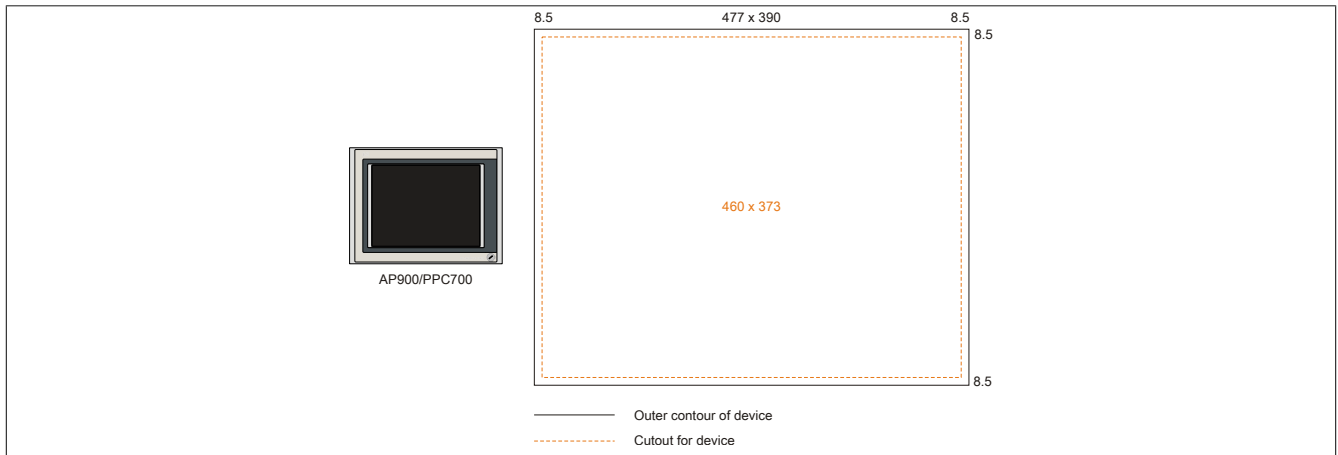

The 17" Automation Panel 900 and Panel PC 700 in Landscape1 format are 100% compatible.

**A.H.2.7 19" devices**

The cutout tolerance for the PP100/200, PP300/400, PP500, AP900, PPC700 and PPC800 is  $\pm 0.5$  mm.  
 The cutout tolerance for the AP1000 is +0 mm / -0.5 mm.

**Installation compatibility - 19" devices - Landscape1**

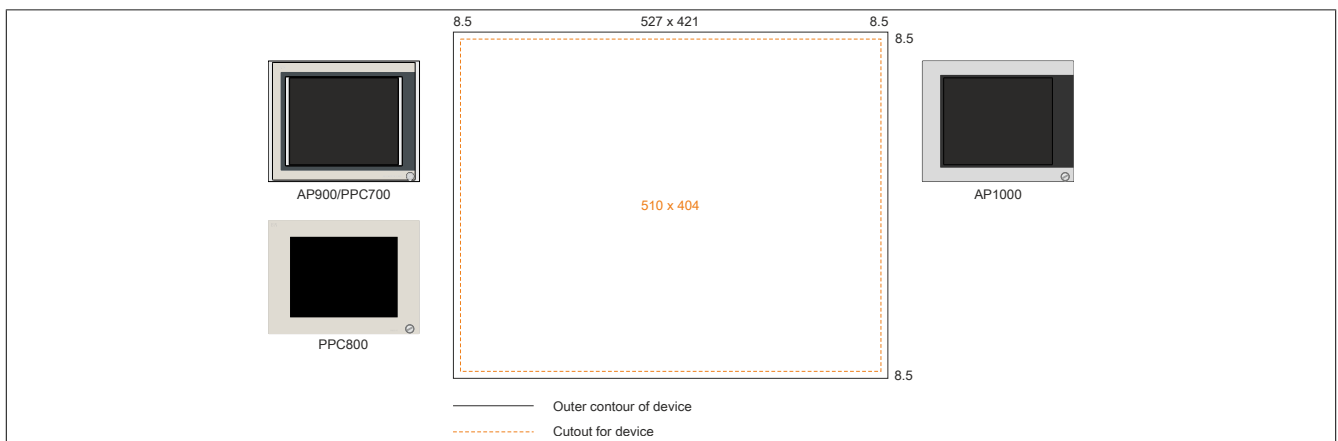

The 19" Automation Panel 1000, Automation Panel 900, Panel PC 700 and Panel PC 800 in Landscape1 format are 100% compatible.

### A.H.2.8 21.3" devices

The cutout tolerance for the PP100/200, PP300/400, PP500, AP900, PPC700 and PPC800 is  $\pm 0.5$  mm.  
The cutout tolerance for the AP1000 is +0 mm / -0.5 mm.

#### Installation compatibility - 21.3" devices - Landscape1

