

Solid-state Timer H3BA-N

Please read and understand this catalog before purchasing the products. Please consult your OMRON representative if you have any questions or comments. Refer to *Warranty and Application Considerations* (page 21), and *Safety Precautions* (page 17).

Solid-state Timer with Valuable Multiple-time Ranges and Multiple-operating Modes

- Handles a wide range of applications through eight operating modes.
- With H3BA-N8H models, the output type can be switched between time-limit DPDT and time-limit SPDT + instantaneous SPDT using a selector.
- Setting rings (order separately) to enable consistent settings and to limit the setting range.
- Panel Covers (order separately) to enable various panel designs.
- CE marking.
UL, CSA and CCC certification, conforms to LR.



■ Broad Line-up of H3B□-N Series

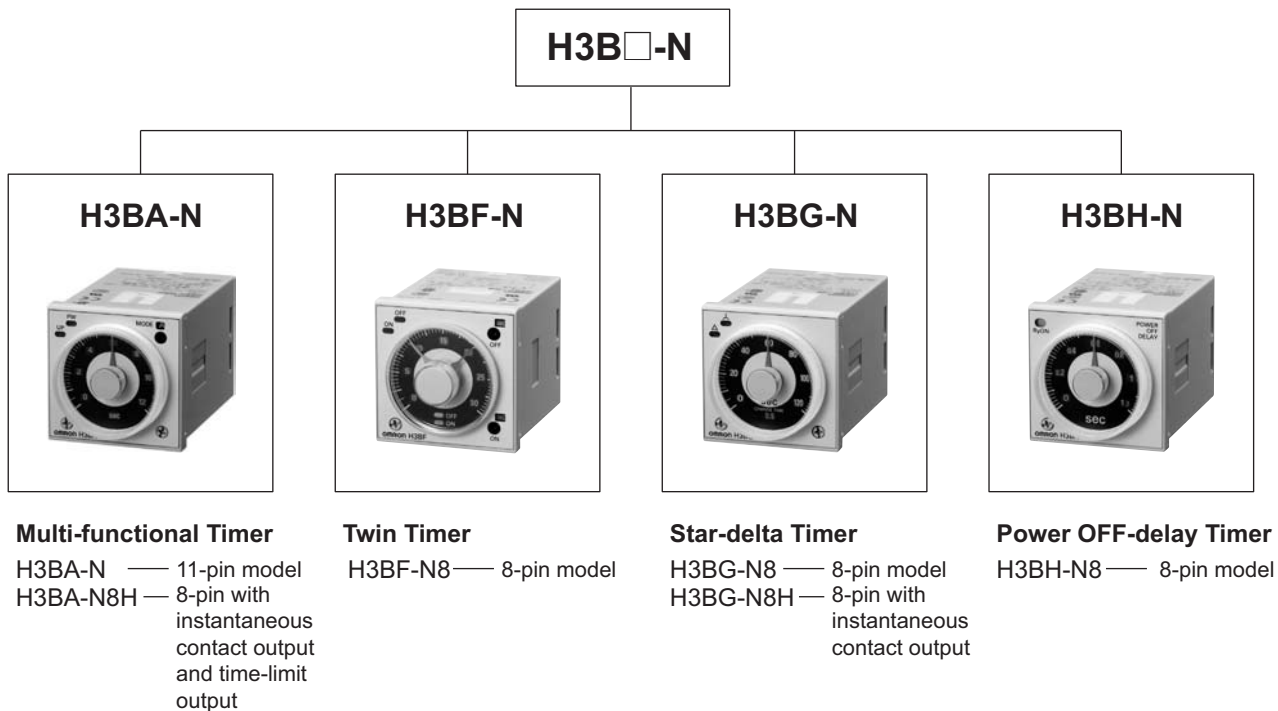

Note: Refer to the *H3BF-N/BG-N/BH-N Datasheet* (Cat. No. L094-E1-02) for details.

Model Number Structure

Model Number Legend

H3BA-N□

1

1. Number of Pins/Output

None: 11-pin models/Time-limit DPDT

8H: 8-pin models/Time-limit SPDT and switchable SPDT (time-limit ↔ instantaneous)

Ordering Information

List of Models

Control output	Supply voltage	11-pin models	8-pin models
Contact output: DPDT (time-limit output)	110 VAC (50/60 Hz)	H3BA-N 110 VAC	---
	220 VAC (50/60 Hz)	H3BA-N 220 VAC	
	24 VDC	H3BA-N 24 VDC	
Contact output: Time-limit SPDT and switchable SPDT (time-limit ↔ instantaneous)	110 VAC (50/60 Hz)	---	H3BA-N8H 110 VAC
	220 VAC (50/60 Hz)		H3BA-N8H 220 VAC
	24 VDC		H3BA-N8H 24 VDC

Accessories (Order Separately)

Name/specifications		Models
Flush Mounting Adapters		Y92F-30
		Y92F-70
		Y92F-71
Mounting Tracks	50 cm (l) × 7.3 mm (t)	PFP-50N
	1 m (l) × 7.3 mm (t)	PFP-100N
	1 m (l) × 16 mm (t)	PFP-100N2
End Plate		PFP-M
Spacer		PFP-S
Protective Cover		Y92A-48B
Track Mounting/ Front Connecting Sockets	8-pin	P2CF-08
	11-pin	P2CF-11
Back Connecting Sockets	8-pin	P3G-08
	11-pin	P3GA-11
Time Setting Rings	Setting a specific time	Y92S-27
	Limiting the setting range	Y92S-28
Panel Covers (See note 1.)	Light gray (5Y7/1)	Y92P-48GL
	Black (N1.5)	Y92P-48GB
Hold-down Clips (See note 2.)	For PL08 Socket	Y92H-1
	For PF085A Socket	Y92H-2

Note: 1. The Time Setting Ring and Panel Cover are sold together.

2. Hold-down Clips are sold in sets of two.

Specifications

General

Item	H3BA-N	H3BA-N8H																																				
Operating mode	A: ON-delay B: Flicker OFF start B2: Flicker ON start C: Signal ON/OFF-delay D: Signal OFF-delay E: Interval G: Signal ON/OFF-delay J: One-shot	A: ON-delay H: ON-delay with instantaneous output contact																																				
Pin type	11-pin	8-pin																																				
Input type	No-voltage input	---																																				
Output type	DPDT (time-limit)	SPDT (time-limit) and switchable SPDT (time-limit <---> instantaneous)																																				
Mounting method	DIN track mounting, surface mounting, and flush mounting																																					
Approved standards	UL508 *1, CSA C22.2 No.14, LR, CCC: GB/T 14048.5 *2 Conforms to EN61812-1 (Pollution degree 2 / Overvoltage category III)																																					
EMC	<table border="0"> <tr> <td>(EMI)</td> <td>EN61812-1</td> <td></td> </tr> <tr> <td>Radiated Emissions:</td> <td>EN 55011 class A</td> <td></td> </tr> <tr> <td>Emission AC Mains:</td> <td>EN 55011 class A</td> <td></td> </tr> <tr> <td>(EMS)</td> <td>EN61812-1</td> <td></td> </tr> <tr> <td>ESD Immunity:</td> <td>EN 61000-4-2:</td> <td>6 kV contact discharge, 8 kV air discharge</td> </tr> <tr> <td>Radiated Radio-Frequency</td> <td>EN 61000-4-3:</td> <td>10 V/m (80 MHz to 1 GHz AM modulation)</td> </tr> <tr> <td>Electromagnetic Field Immunity:</td> <td></td> <td>3 V/m (1.4 GHz to 2 GHz AM modulation) 1 V/m (2 GHz to 2.7 GHz AM modulation) 10 V/m (900 MHz Pulse modulation)</td> </tr> <tr> <td>Conducted disturbances:</td> <td>EN 61000-4-6:</td> <td>10 V (0.15 MHz to 80 MHz)</td> </tr> <tr> <td>Burst Immunity:</td> <td>EN 61000-4-4:</td> <td>2 kV power line 2 kV I/O signal line</td> </tr> <tr> <td>Surge Immunity:</td> <td>EN 61000-4-5:</td> <td>2 kV common mode 1 kV differential mode</td> </tr> <tr> <td>Voltage dips:</td> <td>EN 61000-4-11</td> <td></td> </tr> <tr> <td>Voltage interruptions:</td> <td>EN 61000-4-11</td> <td></td> </tr> </table>		(EMI)	EN61812-1		Radiated Emissions:	EN 55011 class A		Emission AC Mains:	EN 55011 class A		(EMS)	EN61812-1		ESD Immunity:	EN 61000-4-2:	6 kV contact discharge, 8 kV air discharge	Radiated Radio-Frequency	EN 61000-4-3:	10 V/m (80 MHz to 1 GHz AM modulation)	Electromagnetic Field Immunity:		3 V/m (1.4 GHz to 2 GHz AM modulation) 1 V/m (2 GHz to 2.7 GHz AM modulation) 10 V/m (900 MHz Pulse modulation)	Conducted disturbances:	EN 61000-4-6:	10 V (0.15 MHz to 80 MHz)	Burst Immunity:	EN 61000-4-4:	2 kV power line 2 kV I/O signal line	Surge Immunity:	EN 61000-4-5:	2 kV common mode 1 kV differential mode	Voltage dips:	EN 61000-4-11		Voltage interruptions:	EN 61000-4-11	
(EMI)	EN61812-1																																					
Radiated Emissions:	EN 55011 class A																																					
Emission AC Mains:	EN 55011 class A																																					
(EMS)	EN61812-1																																					
ESD Immunity:	EN 61000-4-2:	6 kV contact discharge, 8 kV air discharge																																				
Radiated Radio-Frequency	EN 61000-4-3:	10 V/m (80 MHz to 1 GHz AM modulation)																																				
Electromagnetic Field Immunity:		3 V/m (1.4 GHz to 2 GHz AM modulation) 1 V/m (2 GHz to 2.7 GHz AM modulation) 10 V/m (900 MHz Pulse modulation)																																				
Conducted disturbances:	EN 61000-4-6:	10 V (0.15 MHz to 80 MHz)																																				
Burst Immunity:	EN 61000-4-4:	2 kV power line 2 kV I/O signal line																																				
Surge Immunity:	EN 61000-4-5:	2 kV common mode 1 kV differential mode																																				
Voltage dips:	EN 61000-4-11																																					
Voltage interruptions:	EN 61000-4-11																																					

*1.Surrounding air temperature: 0°C to 40°C

*2.CCC certification requirements

Recommended fuse	0216005 (250 VAC, 5 A) manufactured by Littelfuse
Rated operating voltage Ue	AC-15: Ue: 250 VAC, Ie: 3 A
Rated operating current Ie	AC-13: Ue: 250 VAC, Ie: 5 A DC-13: Ue: 30 VDC, Ie: 1.5 A
Rated insulation voltage	250 V
Rated impulse withstand voltage (altitude: 2,000 m max.)	4 kV (at 240 VAC)
Conditional short-circuit current	1,000 A

Time Ranges

Full scale setting	Time unit	sec	× 10 s	min	× 10 m	hrs	× 10 h
1.2	Set time	0.05 to 1.2	1.2 to 12	0.12 to 1.2	1.2 to 12	0.12 to 1.2	1.2 to 12
3		0.3 to 3	3 to 30	0.3 to 3	3 to 30	0.3 to 3	3 to 30
12		1.2 to 12	12 to 120	1.2 to 12	12 to 120	1.2 to 12	12 to 120
30		3 to 30	30 to 300	3 to 30	30 to 300	3 to 30	30 to 300

■ Ratings

Item	H3BA-N	H3BA-N8H
Rated supply voltage (See notes 1 and 2)	110 VAC (50/60 Hz), 220 VAC (50/60 Hz), 24 VDC	
Operating voltage range (See note 3)	85% to 110% of rated supply voltage	
Power reset	Minimum power-opening time: 0.1 s	
No-voltage input	ON impedance: 1 kΩ max. ON residual voltage: 1 V max. OFF impedance: 200 kΩ min.	
Power consumption	110 VAC: Approx. 4.6 VA (1.5 W) 220 VAC: Approx. 7.6 VA (1.3 W) 24 VDC: Approx. 0.6 W	110 VAC: Approx. 3.6 VA (1.6 W) 220 VAC: Approx. 7.8 VA (1.9 W) 24 VDC: Approx. 0.9 W
Control outputs	Contact: 5 A at 250 VAC, resistance load (cosφ = 1)	

Note: 1. DC ripple rate: 20% max.

2. Models other than 24-VDC H3BA-N models cause an inrush current. Pay careful attention when attempting to turn on power to such models with non-contact output from a device such as a sensor.
3. 90% or higher if the Timer is used continuously at a high ambient temperature.

■ Characteristics

Item	H3BA-N	H3BA-N8H
Accuracy of operating time	±0.3% FS max. (±0.3%±10 ms in a range of 1.2 s)	
Setting error	±5% FS ±0.05 s max.	
Reset time	Min. power-opening time: 0.1 s max. Min. pulse-input time: 50 ms	
Influence of voltage	±0.5% FS max. (±0.5%±10 ms in a range of 1.2 s)	
Influence of temperature	±2% FS max. (±2%±10 ms in a range of 1.2 s)	
Insulation resistance	100 MΩ min. (at 500 VDC)	
Dielectric strength	2,000 VAC, 50/60 Hz for 1 min between current-carrying metal parts and exposed non-current-carrying metal parts 2,000 VAC, 50/60 Hz for 1 min between control output terminals and operating circuit 1,000 VAC, 50/60 Hz for 1 min between contacts not located next to each other (750 VAC for H3BA-N8H)	
Impulse withstand voltage	1 kV (between power terminals) 2 kV (between current-carrying terminal and exposed non-current-carrying metal parts, 1.5 kV for 24-VDC models)	
Noise immunity	AC models: ±1.5 kV (between power terminals), and ±600 V (between input terminals), square-wave noise by noise simulator (pulse width: 100 ns/1 μs, 1-ns rise) DC models: ±480 V (between power terminals), and ±600 V (between input terminals), square-wave noise by noise simulator (pulse width: 100 ns/1 μs, 1-ns rise)	
Static immunity	Malfunction: 4 kV Destruction: 8 kV	
Vibration resistance	Destruction: 10 to 55 Hz with 0.75-mm single amplitude each in three directions Malfunction: 10 to 55 Hz with 0.5-mm single amplitude each in three directions	
Shock resistance	Destruction: 1,000 m/s ² (approx. 100G) each in three directions Malfunction: 100 m/s ² (approx. 10G) each in three directions	
Ambient temperature	Operating: -10°C to 55°C (with no icing) Storage: -25°C to 65°C (with no icing)	
Ambient humidity	Operating: 35% to 85%	
Life expectancy	Mechanical: 10 million operations min. (under no load at 1,800 operations/h) Electrical: 100,000 operations min. (5 A at 250 VAC, resistive load at 1,800 operations/h)	Mechanical: 10 million operations min. (under no load at 1,800 operations/h) Electrical: 100,000 operations min. (5 A at 250 VAC, resistive load at 360 operations/h)
Case color	Light gray (Munsell 5Y7/1)	
Enclosure ratings	IEC: IP40 (panel surface)	
Weight	Approx. 95 g	

Note: For setting the time-limit of the Timer to a cycle of less than 3 seconds or applying the forced reset, use the H3BA-N in mode D (signal OFF-delay).

Nomenclature

H3BA-N

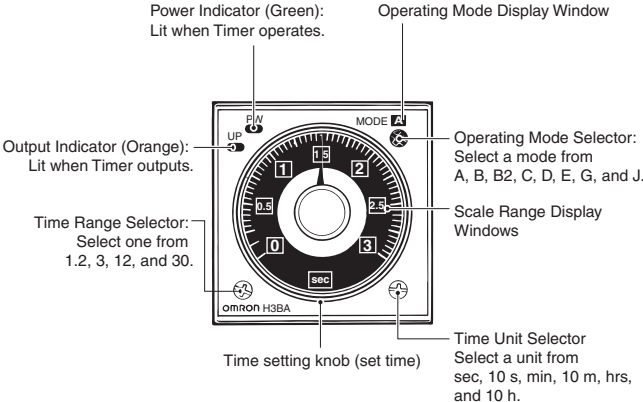

H3BA-N8H

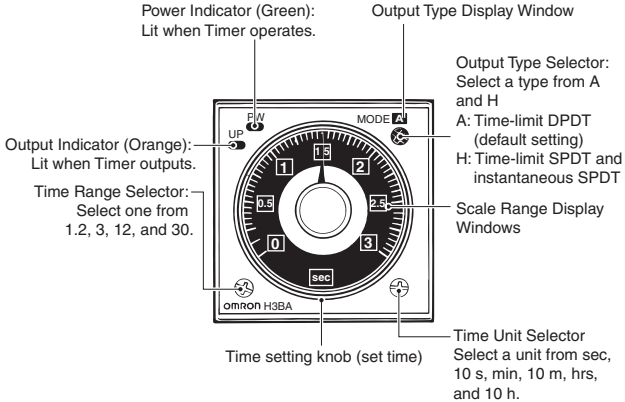

Operation

Block Diagrams

H3BA-N

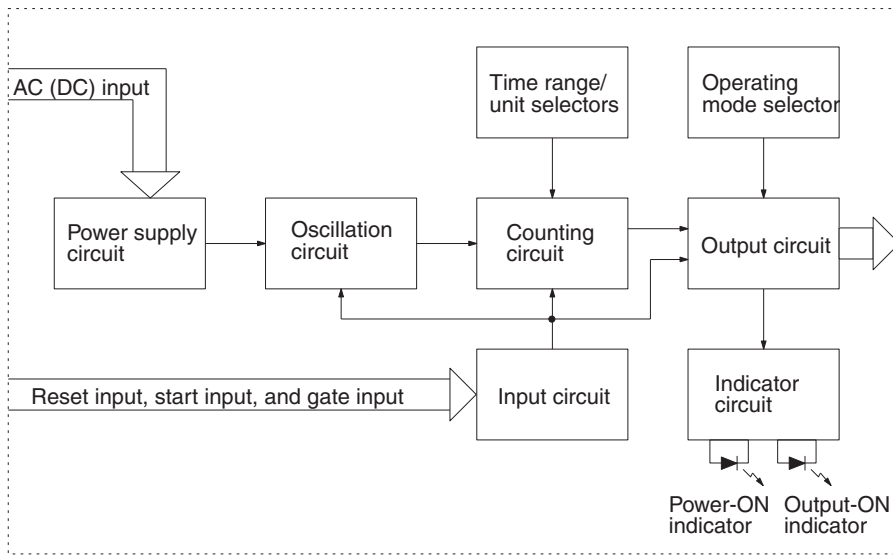

H3BA-N8H

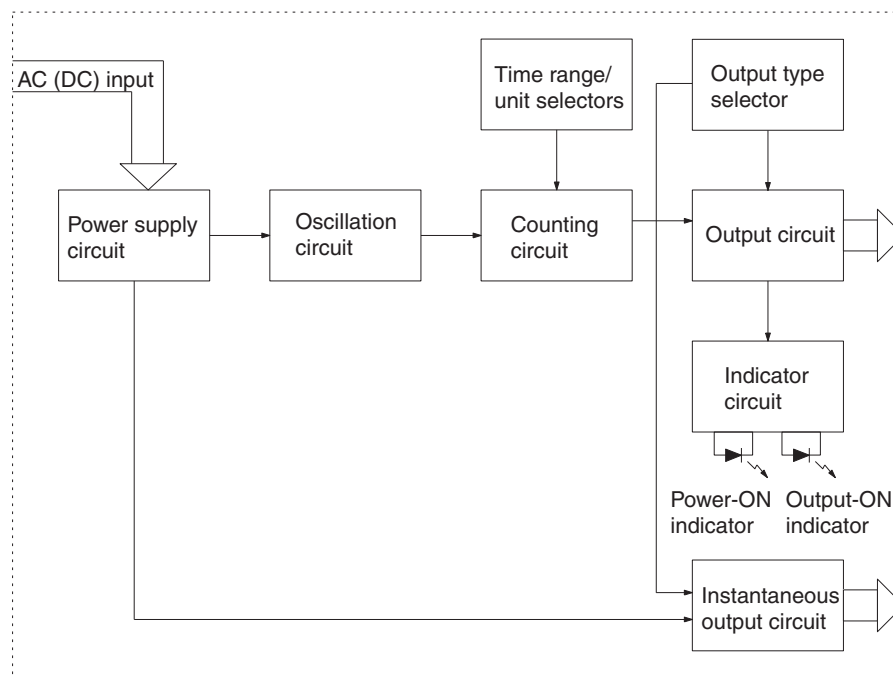

I/O Functions

Inputs	Start	Starts time-measurement.
	Reset	Interrupts time-measurement and resets time-measurement value. No time-measurement is made and control output is OFF while the reset input is ON.
	Gate	Prohibits time-measurement.
Outputs	Control output	Outputs are turned ON according to designated output mode when preset value is reached.

Basic Setting

Setting of Selector

The selectors can be turned clockwise and counterclockwise to select the desired time unit, time range, output type (only for H3BA-N8H) or operating mode. Each selector has a snap mechanism that secures the selector at a given position. Set the selector at a position at which it is secured. Do not set it midway between two securing positions or a malfunction could result from improper setting.

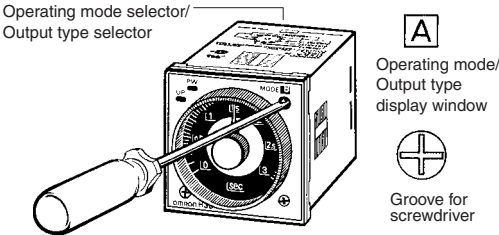

Selection of Operating Mode with H3BA-N

Turn the operating mode selector with a screwdriver until the desired operating mode (A, B, B2, C, D, E, G, or J) appears in the display window located above the selector.

Selection of Output Type with H3BA-N8H

Turn the output type selector with a screwdriver until the desired output type (A or H) appears in the display window located above the selector.

Selection of Time Unit and Time Range

The desired time unit (sec, 10 s, min, 10 m, hrs, or 10 h) is displayed in the window below the time setting knob by turning the time unit selector located at the lower right corner of the front panel. A time range (1.2, 3, 12, or 30) is selected with the time range selector at the lower left corner of the front panel, and the selected time range appears (in the window at the lower right part) within the plastic frame of the time setting knob.

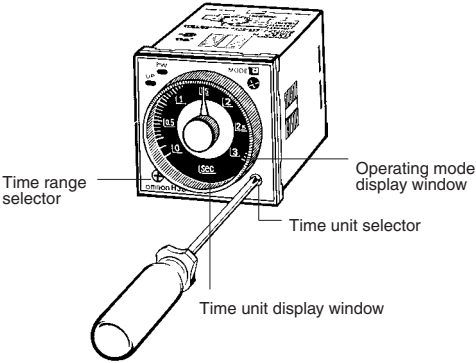

Setting of Time

Use the time setting knob to set the desired time.

Using the Setting Ring

Setting a Specific Time

Mount the Panel Cover on the Timer, set the desired time with the time setting knob, and place Time Setting Ring A onto the time setting knob so that the time setting notch of Time Setting Ring A is in the center of the reset lock position of the Panel Cover.

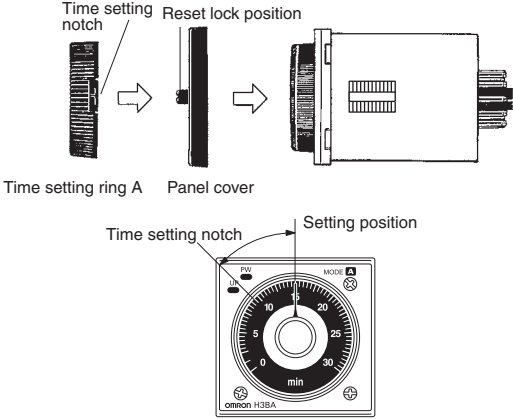

Example: To set the time to 10 s.

Limiting the Setting Range

Example: To set a range of 10 and 20 s. Mount the Panel Cover on the Timer, set the time setting knob to 10 s (the lower limit of the setting range), and place Time Setting Ring C onto the time setting knob so that the stopper of Time Setting Ring C is on the right edge of the reset lock position of the Panel Cover. Next, set the time setting knob to 20 s (the upper limit of the setting range), place Time Setting Ring B onto the time setting knob so that the stopper of Time Setting Ring B is on the left edge of the reset lock position of the Panel Cover.

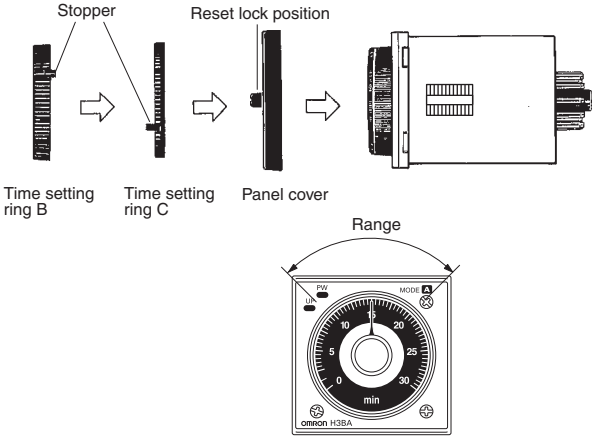

■ Timing Chart

- Note:** 1. The minimum power-opening time ("Rt") is 0.1 s and the minimum pulse width is 0.05 s.
 2. The letter "t" in the timing charts stands for the set time and "t-a" means that the period is less than the time set.

H3BA-N

Operating mode	Timing chart	
A: ON-delay		<div style="border: 1px solid black; padding: 2px; display: inline-block;">Basic operation</div>
B: Flicker OFF start		<div style="border: 1px solid black; padding: 2px; display: inline-block;">Basic operation</div>
B2: Flicker ON start		<div style="border: 1px solid black; padding: 2px; display: inline-block;">Basic operation</div>
C: Signal ON/OFF-delay		<div style="border: 1px solid black; padding: 2px; display: inline-block;">Basic operation</div>

Operating mode	Timing chart
<p>D: Signal OFF-delay</p>	<p>Power 2 and 10</p> <p>Start 2 and 6</p> <p>Reset 2 and 7</p> <p>Output relay 1 and 4 (11 and 8) (NC)</p> <p>Output relay (NO) (Output indicator) 1 and 3 (11 and 9)</p> <p>Power indicator</p> <p>Basic operation</p> <p>Power</p> <p>Start</p> <p>Output</p>
<p>E: Interval</p>	<p>Power 2 and 10</p> <p>Start 2 and 6</p> <p>Reset 2 and 7</p> <p>Output relay 1 and 4 (11 and 8) (NC)</p> <p>Output relay (NO) (Output indicator) 1 and 3 (11 and 9)</p> <p>Power indicator</p> <p>Basic operation</p> <p>Power</p> <p>Start</p> <p>Output</p>
<p>G: Signal ON/OFF-delay</p>	<p>Power 2 and 10</p> <p>Start 2 and 6</p> <p>Reset 2 and 7</p> <p>Output relay 1 and 4 (11 and 8) (NC)</p> <p>Output relay (NO) (Output indicator) 1 and 3 (11 and 9)</p> <p>Power indicator</p> <p>Basic operation</p> <p>Power</p> <p>Start (See note)</p> <p>Output</p> <p>Note: Start input is valid and retriggerable while the Timer is in operation.</p>
<p>J: One-shot output</p>	<p>Power 2 and 10</p> <p>Start 2 and 6</p> <p>Reset 2 and 7</p> <p>Output relay 1 and 4 (11 and 8) (NC)</p> <p>Output relay (NO) (Output indicator) 1 and 3 (11 and 9)</p> <p>Power indicator</p> <p>Basic operation</p> <p>Power</p> <p>Start (See note)</p> <p>Output</p> <p>Note: Start input is valid and retriggerable while the Timer is in operation. (Previous start input will be cancelled.)</p>

Gate Signal Input in Operating Mode A (ON-delay Operation)

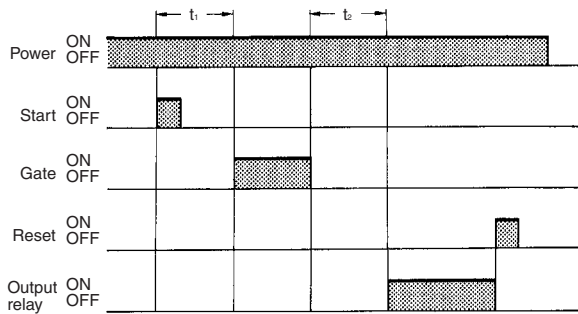

Note: The set time is the sum of t_1 and t_2 .

H3BA-N8H, Output Type: A Type

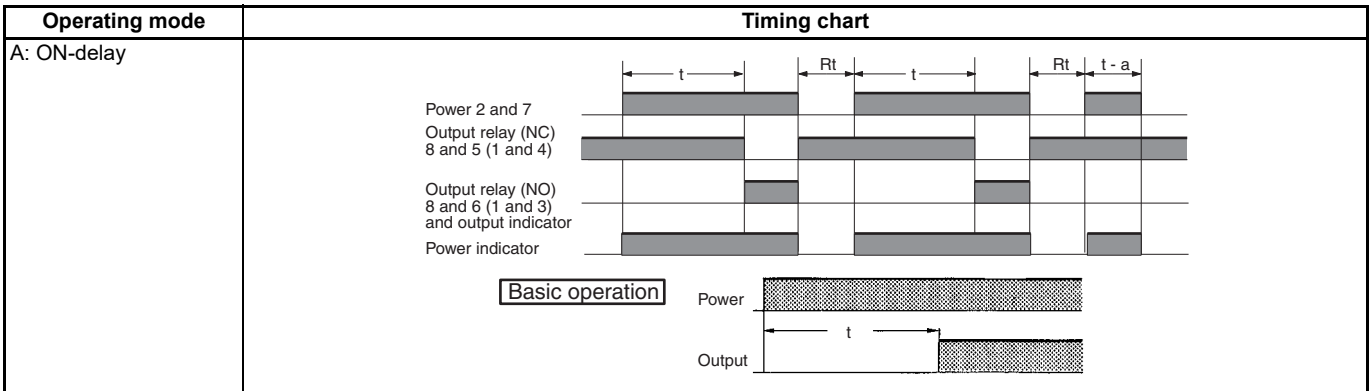

H3BA-N8H, Output Type: H Type

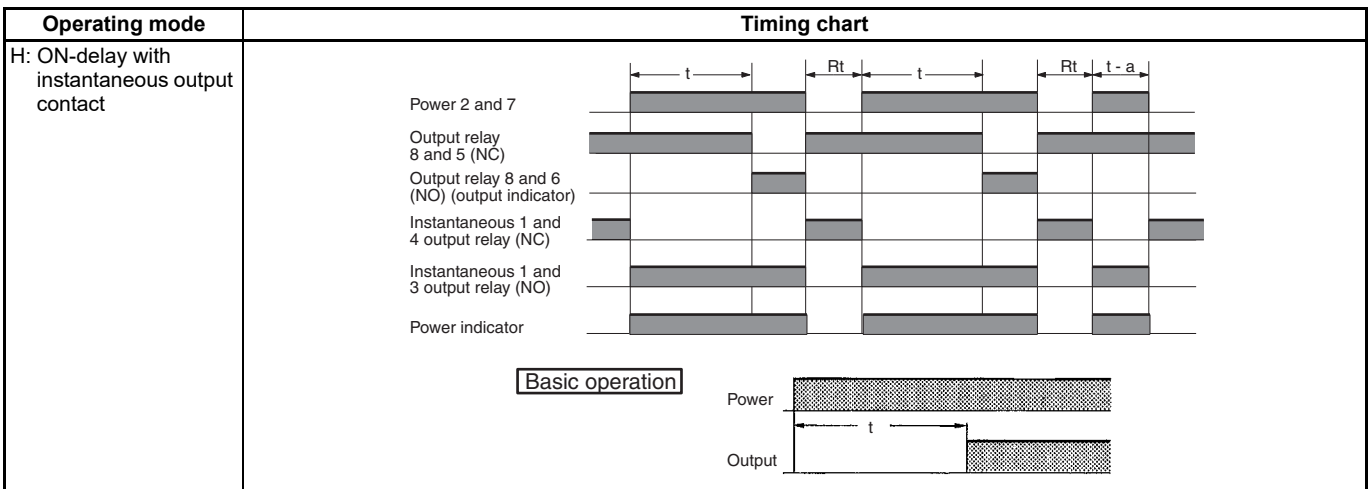

Dimensions

Note: All units are in millimeters unless otherwise indicated.

H3BA-N

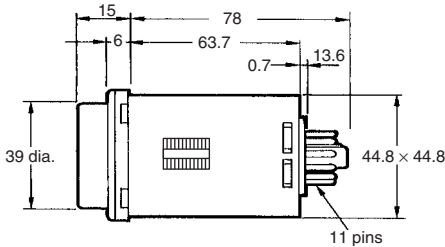
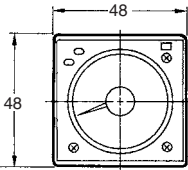
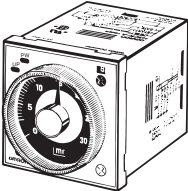

H3BA-N8H

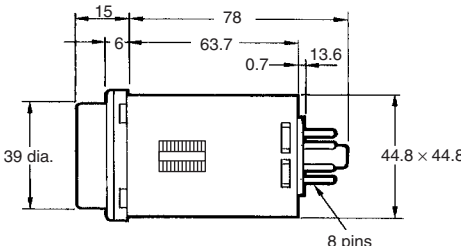
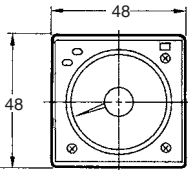
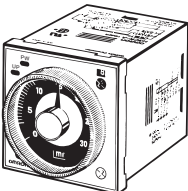

Dimensions with Set Ring

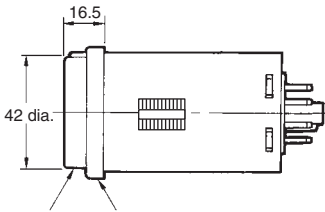
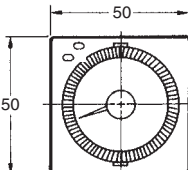
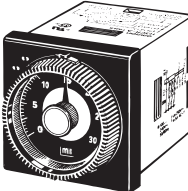

Time setting ring Panel cover

Dimensions with Y92F-30 Flush Mounting Adapter

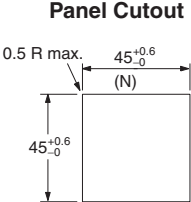
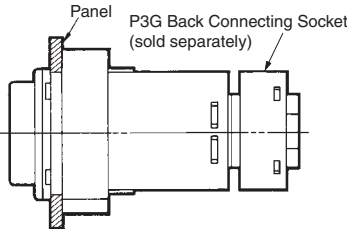
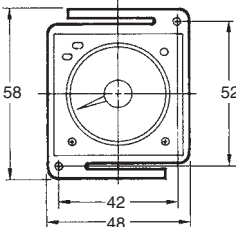
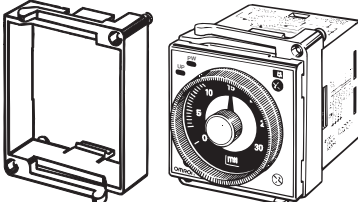

Note: The mounting panel thickness should be 1 to 5 mm.

Dimensions with Y92F-70 Flush Mounting Adapter

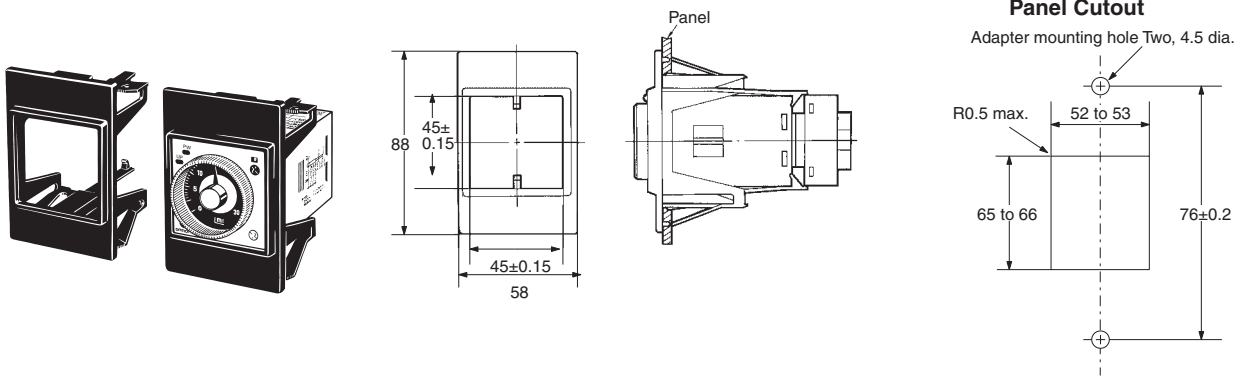

Dimensions with Y92F-71 Flush Mounting Adapter

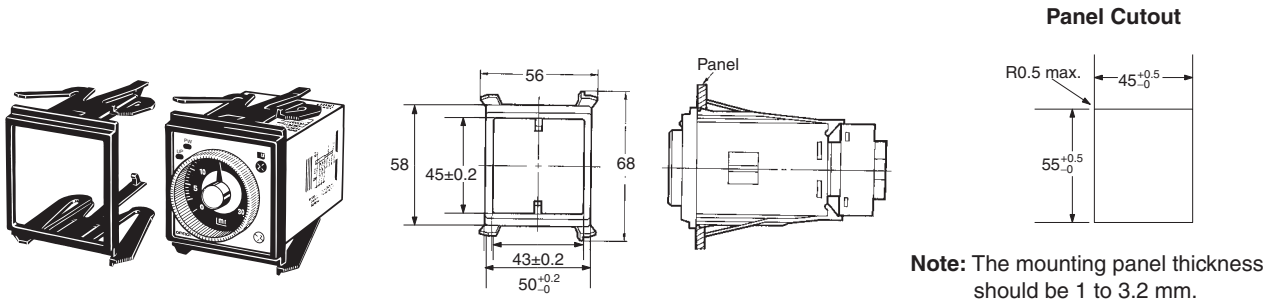

Track Mounting

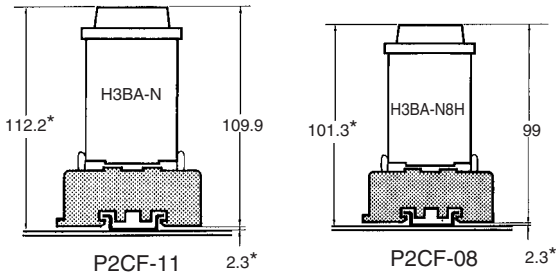

Note: These dimensions vary with the kind of DIN track (reference value).

Flush Mounting

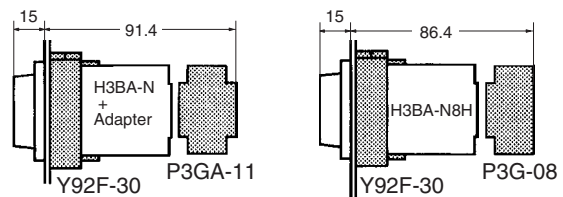

■ Accessories (Order Separately)

Track Mounting/Front Connecting Socket

P2CF-08

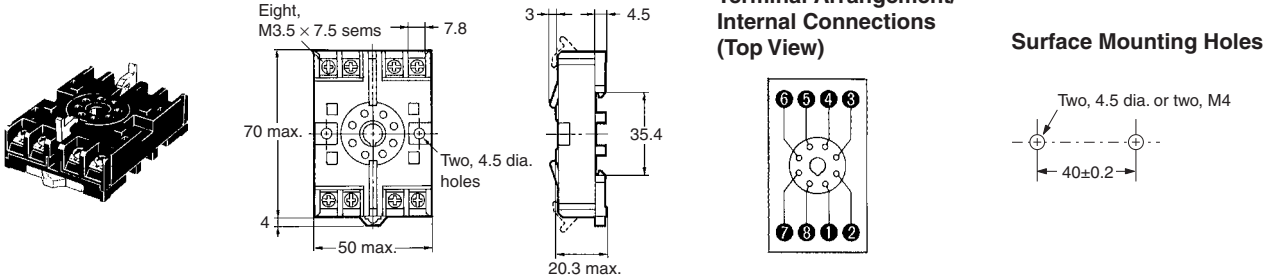

P2CF-11

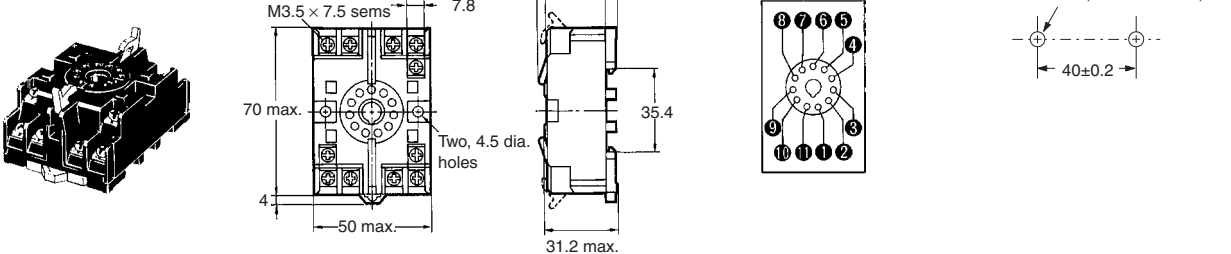

Back Connecting Socket

P3G-08

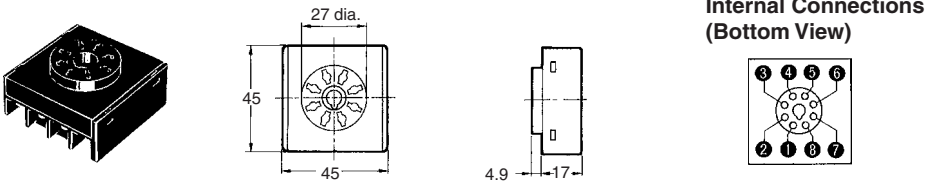

P3GA-11

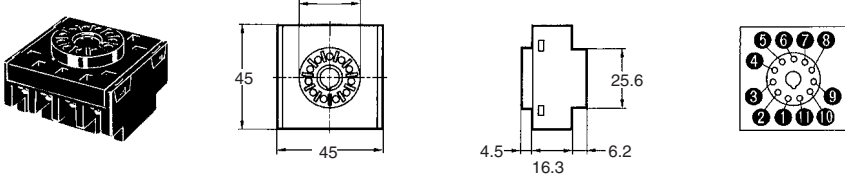

Mounting Track

PFP-100N, PFP-50N

PFP-100N2

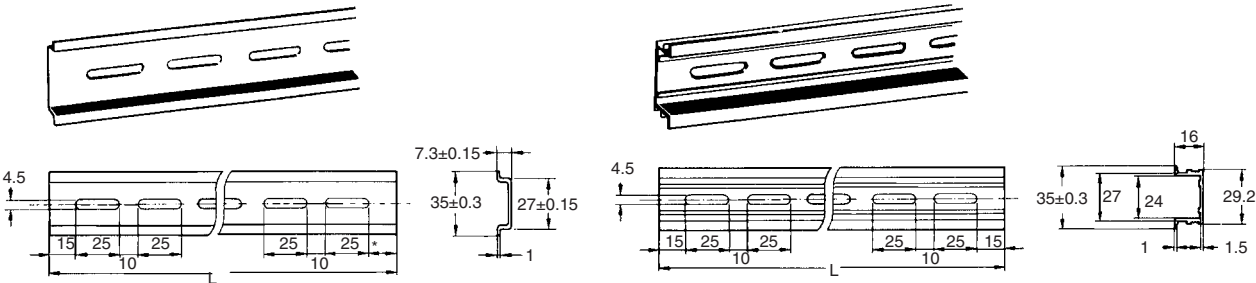

L: Length

1 m	PFP-100N
50 cm	PFP-50N
1 m	PFP-100N2

End Plate

PFP-M

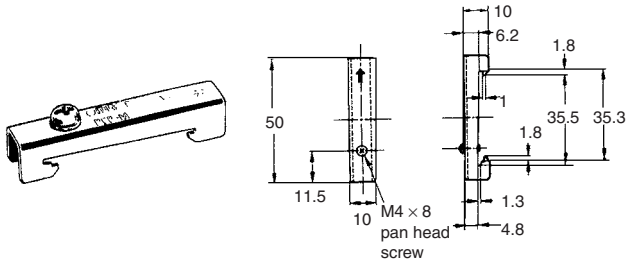

Spacer

PFP-S

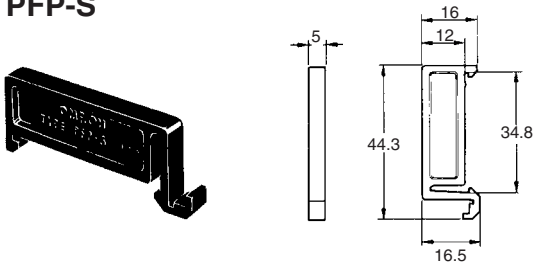

Protective Cover

Y92A-48B

The protective cover protects the front panel, particularly the time setting section, against dust, dirt, and water. It also prevents the set value from being altered due to accidental contact with the time setting knob.

- Note:**
1. The Y92A-48B Protective Cover is made of a hard plastic and therefore it must be removed to change the timer set value.
 2. The Protective Cover cannot be mounted if the Panel Cover (sold separately) is used on the Timer.

Y92A-48B

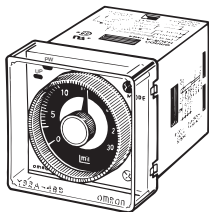

Time Setting Ring/Panel Cover

There are two types of Panel Covers (Y92P-48GL, Y92P-48GB), all of which are available in two colors. Use the most suitable type of Panel Cover with the design of the scaling plate according to the application.

When setting a given time for the Timer, use of the Y92S-27 or Y92S-28 Time Setting Ring facilitates the time setting operation and minimizes possible setting errors by operators.

The Time Setting Ring and Panel Cover should be used as a pair.

Setting a specific time	Time Setting Ring A (Y92S-27) and Panel Cover (Y92P-48GL, -48GB)
Limiting the setting range	Time Setting Ring B or C (Y92S-28), and Panel Cover (Y92P-48GL, -48GB)

Y92S-27 Time Setting A



Y92P-48GL
Light Gray

Y92S-28 Time Setting B



Y92P-48GB
Black

Y92S-28 Time Setting C

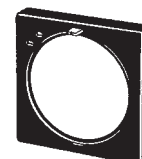
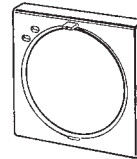

Hold-down Clip

Y92H-1 For PL08 Socket

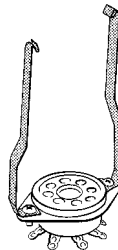

Y92H-2 For PF085A Socket

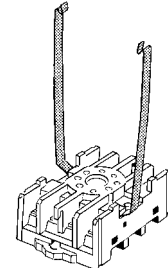

Installation

Terminal Arrangement

H3BA-N (Contact Output)

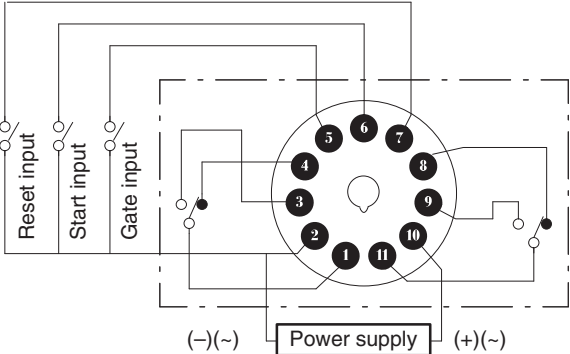

H3BA-N8H (Contact Output)

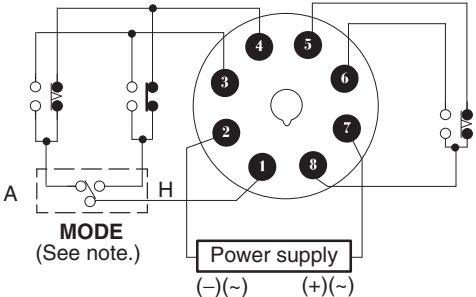

Note: The output contact can be set to either instantaneous or time-limit contact using the output type selector located at the upper right corner of the front panel.

Note: The delayed contacts of conventional timers are shown as follows:



The contact symbol of the H3BA-N is expressed as follows because of its multiple operating modes:



The instantaneous contacts of conventional timers are shown as follows:



Input Connections

The inputs of the H3BA-N are no-voltage (short circuit or open) inputs.

No-voltage Inputs

No-contact Input

(Connection to NPN open collector output sensor.)

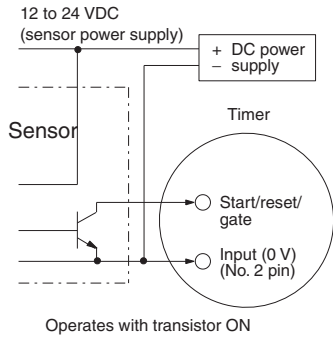

Contact Input

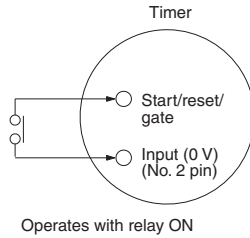

No-contact Input

(Connection to a voltage output sensor.)

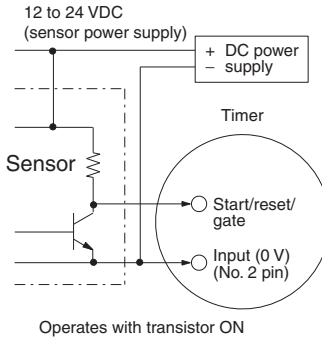

No-voltage Input Signal Levels





No-contact input	1. Short-circuit level Transistor ON Residual voltage: 1 V max. Impedance when ON: 1 kΩ max.
	2. Open level Transistor OFF Impedance when OFF: 200 kΩ min.
Contact input	Use contacts which can adequately switch 0.1 mA at 5 V

Safety Precautions

Warning Indications

 CAUTION	Indicates a potentially hazardous situation which, if not avoided, may result in minor or moderate injury or in property damage.
Precautions for Safe Use	Supplementary comments on what to do or avoid doing, to use the product safely.
Precautions for Correct Use	Supplementary comments on what to do or avoid doing, to prevent failure to operate, malfunction or undesirable effect on product performance.

Meaning of Product Safety Symbols

	Used to warn of the risk of electric shock under specific conditions.
	Used to warn of the risk of minor injury caused by high temperatures
	Used for general mandatory action precautions for which there is no specified symbol.
	Use to indicate prohibition when there is a risk of minor injury from electrical shock or other source if the product is disassembled.

CAUTION

Minor electric shock may occasionally occur. Do not disassemble the product or touch the interior of the Timer.



Minor burns may occasionally occur. Do not touch the product while power is being supplied or immediately after power is turned OFF.



Minor fires may occasionally occur. Tighten terminal screws to a torque of 1.08 N·m so that they do not become loose.



Minor electric shock may occasionally occur during operation. Install the terminal cover.



Minor electric shock, fire, or malfunction may occasionally occur.

Do not allow metal fragments, lead wire scraps, or chips from processing during installation to fall inside the Timer.



■ Precautions for Safe Use

Please observe the following precautions for safe use of this product.

Environmental Precautions

Store the Timer within specified ratings. If the Timer has been stored at -10°C or lower, let it stand for 3 hours or longer at room temperature before turning ON the power supply.

Use the Timer within the specified ratings for operating temperature and humidity.

Do not operate the Timer in locations subject to sudden or extreme changes in temperature, or locations where high humidity may result in condensation.

Do not use the Timer in locations subject to excessive dust, corrosive gas, or direct sunlight.

Do not use the Timer in locations subject to vibration or shock. Extended use in such locations may result in damage due to stress.

Install the Timer well away from any sources of static electricity, such as pipes transporting molding materials, powders, or liquids.

Usage Precautions

Install a switch or circuit breaker that allows the operator to immediately turn OFF the power, and label it to clearly indicate its function.

Pay careful attention to polarity to prevent wrong connections when wiring terminals.

Internal elements may be destroyed if a voltage outside the rated voltage is applied.

Maintain voltage fluctuations in the power supply within the specified range.

The Timer uses a transformerless power supply. Do not touch the input terminals while the supply voltage is being applied, otherwise an electric shock may occur.

■ Precautions for Correct Use

Changing the Setting

Do not change the time unit, time range, or operation mode while the Timer is in operation, otherwise the Timer may malfunction.

Connecting the Operating Power Supply

The H3BA-N□ contains a capacitor-drop power circuit. Use a sinusoidal power supply with a commercial frequency. Do not use power supplies with a high frequency component (such as inverter power supplies) for Timers with 110 or 220-VAC specifications. Using these power supplies can damage internal circuits.

If voltages other than the rated voltage is applied, the internal components may be damaged. The internal element (varistor) will be damaged if a voltage of higher than 100 VAC is applied to the 24-VDC line.

Connect the power supply voltage through a relay or switch in such a way that the voltage reaches a fixed value immediately or the Timer may not be reset or a timer error could result.

A DC power supply can be connected if its ripple factor is 20% or less and the mean voltage is within the rated operating voltage range of the Timer.

If the wiring to the terminal 2 (common terminal for both the power supply and input signals) is broken, the internal circuit will be destroyed.

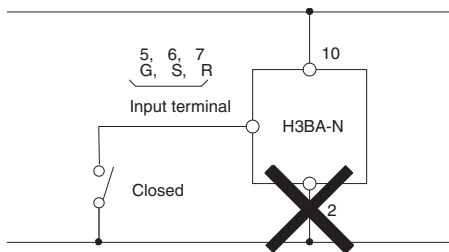

Input/Output

An appropriate input will be applied to the input signal terminals of the Timer when one of the input terminals (terminals 5, 6, and 7) and the common terminal (terminal 2) for the input signals are short-circuited. Do not attempt to connect any input terminal to any terminal other than the common terminal or to apply voltage across other than the specified input and common terminals or the internal circuits of the Timer may be damaged.

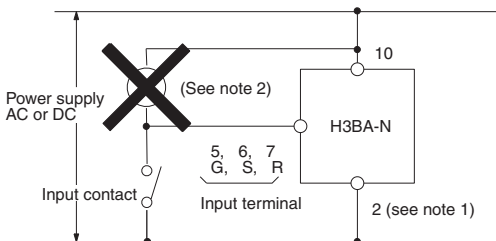

- Note: 1.** Power supply terminal 2 is a common terminal for the input signals (G, S, R) to the Timer. Never use terminal 10 as the common terminal for this purpose, otherwise the internal circuit of the Timer may be damaged.
- 2.** Do not connect a relay or any other load between these two points, otherwise the internal circuit of the Timer may be damaged due to the high-tension voltage applied to the input terminals.

Operating Time Setting

When setting the operating time, do not turn the setting knob beyond its scale range. For precise time setting, conduct operation tests by adjusting the setting knob.

The accuracy of the operating time of the Analog Timer is indicated by the percentage value on the basis of the full-scale time. The absolute fluctuation value will not be improved by changing the time setting. Therefore, when selecting the model, be sure that the application will be able to use a time setting as close as the full-scale time setting of the Timer.

Others

When conducting a dielectric test, impulse voltage test, or insulation resistance test between the electric circuit and non-current-carrying metal parts of the Timer mounted to a control panel, be sure to take the following steps. These steps will prevent the internal circuitry of the Timer from damage that may be caused if a machine on the control panel has an improper dielectric strength or insulation resistance.

1. Separate the Timer from the circuitry of the control panel by disconnecting the socket from the Timer or wires.
2. Short-circuit all terminals of the Timer.
If any device with no-contact output, such as a proximity sensor, photoelectric sensor, or SSR, is directly connected to the Timer, current leakage from the device may cause Timer malfunction. Be sure to test the device with the Timer before using the device for actual applications.

Before using the Timer to switch inductive loads, be sure to connect a surge absorbing element to the Timer in order to prevent the Timer from malfunction and damage. A diode is an example of a surge absorbing element for DC circuits and a surge absorber is an example of a surge absorbing element for AC circuits.

Do not leave the Timer in time-up condition for a month or longer in places with high temperatures, otherwise the internal parts, such as an electrolytic capacitor, of the Timer may be damaged. Use the Timer with an appropriate relay so that the Timer will not be left in time-up condition for a long time.

If the Timer is mounted in contact with a mounting surface, the service life of internal parts may be shortened. Provide at least 10 mm between the Timer and the mounting surface to prolong the service life of the Timer.

When the Timer is reset right after the Timer goes into time-up condition, be sure to provide the Timer with an appropriate circuit configuration considering the resetting time of the Timer so that a sequential error will not result.

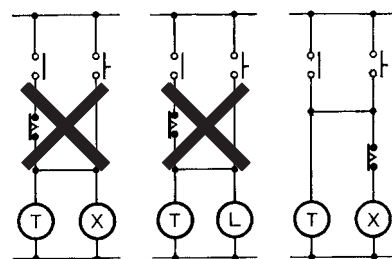

The Timer uses the constant value read method. Be careful when changing the set value because the output of the Timer will be ON when the set value coincides with the count value.

Be sure that the casing of the Timer is free from organic solvents, such as paint thinner and benzene, strong acid, and alkali solvents, which will damage the casing.

Note: It is impossible to connect more than two Timers in parallel.

■ Mounting

Surface Mounting

There is no particular restriction on surface mounting directions, but be sure that the Timer is securely mounted horizontally.

P2CF Socket

When mounting the Timer vertically with the P2CF Socket, consider the movable hooks and be sure that there is a 20-mm space on each of the upper and lower parts of the Socket.

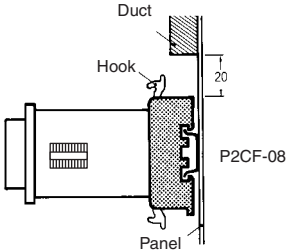

PL Socket

1. Secure the Socket to the panel surface with screws and insert the F-shaped hook into the sockets.

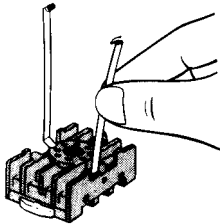

2. Connect the Timer to the Socket and press the tip of each hook by hand.

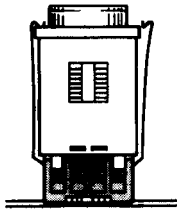

Panel Mounting

When the Y92F-30 Flush Mounting Adapter is used, insert the Timer into the square hole from the front side of the panel and put on the Flush Mounting Adapter from the rear side of the Timer. Press the Flush Mounting Adapter so that the space between the Flush Mounting Adapter and the panel is reduced as much as possible, and secure the Flush Mounting Adapter with screws.

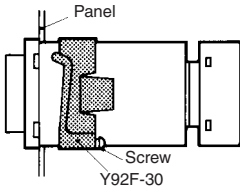

When using the US08, be sure to use 10.5-dia. max. multi-conductor cable or 3-dia. max. insulated stranded wire for wiring.

When the Y92F-30, Y92F-70 or Y92F-71 Flush Mounting Adapter is used, just insert the Timer into the square panel hole. If the panel coating is too thick and the hooks do not click, spread open the hooks appropriately to the left and right after inserting the Timer to the hole.

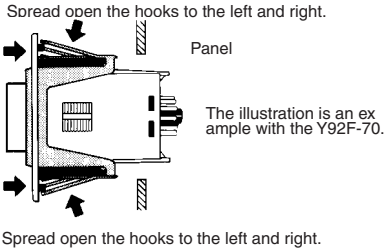

■ Dismounting

Surface Mounting with P2CF

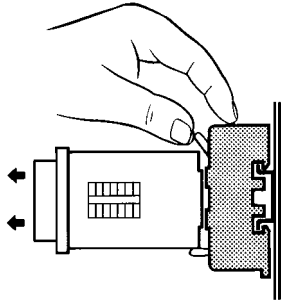

Panel Mounting

Loosen the screws of the Flush Mounting Adapter, spread open the hooks, and remove the Mounting Adapter.

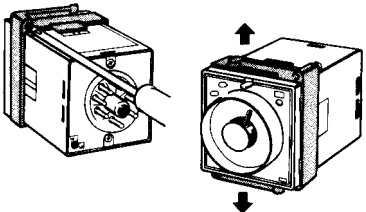

When the Y92F-30, Y92F-70, Y92F-71 Mounting Adapter is used, press the hook inwards with the thumb and index finger of both hands, and press the Timer towards the front side.

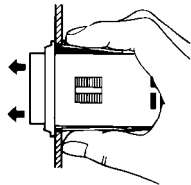

Read and Understand this Catalog

Please read and understand this catalog before purchasing the product. Please consult your OMRON representative if you have any questions or comments.

Warranty and Limitations of Liability

WARRANTY

OMRON's exclusive warranty is that the products are free from defects in materials and workmanship for a period of one year (or other period if specified) from date of sale by OMRON.

OMRON MAKES NO WARRANTY OR REPRESENTATION, EXPRESS OR IMPLIED, REGARDING NON-INFRINGEMENT, MERCHANTABILITY, OR FITNESS FOR PARTICULAR PURPOSE OF THE PRODUCTS. ANY BUYER OR USER ACKNOWLEDGES THAT THE BUYER OR USER ALONE HAS DETERMINED THAT THE PRODUCTS WILL SUITABLY MEET THE REQUIREMENTS OF THEIR INTENDED USE. OMRON DISCLAIMS ALL OTHER WARRANTIES, EXPRESS OR IMPLIED.

LIMITATIONS OF LIABILITY

OMRON SHALL NOT BE RESPONSIBLE FOR SPECIAL, INDIRECT, OR CONSEQUENTIAL DAMAGES, LOSS OF PROFITS OR COMMERCIAL LOSS IN ANY WAY CONNECTED WITH THE PRODUCTS, WHETHER SUCH CLAIM IS BASED ON CONTRACT, WARRANTY, NEGLIGENCE, OR STRICT LIABILITY.

In no event shall the responsibility of OMRON for any act exceed the individual price of the product on which liability is asserted.

IN NO EVENT SHALL OMRON BE RESPONSIBLE FOR WARRANTY, REPAIR, OR OTHER CLAIMS REGARDING THE PRODUCTS UNLESS OMRON'S ANALYSIS CONFIRMS THAT THE PRODUCTS WERE PROPERLY HANDLED, STORED, INSTALLED, AND MAINTAINED AND NOT SUBJECT TO CONTAMINATION, ABUSE, MISUSE, OR INAPPROPRIATE MODIFICATION OR REPAIR.

Application Considerations

SUITABILITY FOR USE

OMRON shall not be responsible for conformity with any standards, codes, or regulations that apply to the combination of the product in the customer's application or use of the product.

Take all necessary steps to determine the suitability of the product for the systems, machines, and equipment with which it will be used.

Know and observe all prohibitions of use applicable to this product.

NEVER USE THE PRODUCT FOR AN APPLICATION INVOLVING SERIOUS RISK TO LIFE OR PROPERTY WITHOUT ENSURING THAT THE SYSTEM AS A WHOLE HAS BEEN DESIGNED TO ADDRESS THE RISKS, AND THAT THE OMRON PRODUCT IS PROPERLY RATED AND INSTALLED FOR THE INTENDED USE WITHIN THE OVERALL EQUIPMENT OR SYSTEM.

PROGRAMMABLE PRODUCTS

OMRON shall not be responsible for the user's programming of a programmable product, or any consequence thereof.

Disclaimers

CHANGE IN SPECIFICATIONS

Product specifications and accessories may be changed at any time based on improvements and other reasons. Consult with your OMRON representative at any time to confirm actual specifications of purchased product.

DIMENSIONS AND WEIGHTS

Dimensions and weights are nominal and are not to be used for manufacturing purposes, even when tolerances are shown.

PERFORMANCE DATA

Performance data given in this catalog is provided as a guide for the user in determining suitability and does not constitute a warranty. It may represent the result of OMRON's test conditions, and the users must correlate it to actual application requirements. Actual performance is subject to the OMRON Warranty and Limitations of Liability.

Note: Do not use this document to operate the Unit.

OMRON Corporation Industrial Automation Company

Kyoto, JAPAN

Contact : www.ia.omron.com

Regional Headquarters

OMRON EUROPE B.V.

Wegalaan 67-69, 2132 JD Hoofddorp
The Netherlands
Tel: (31) 2356-81-300 Fax: (31) 2356-81-388

OMRON ELECTRONICS LLC

2895 Greenspoint Parkway, Suite 200
Hoffman Estates, IL 60169 U.S.A.
Tel: (1) 847-843-7900 Fax: (1) 847-843-7787

OMRON ASIA PACIFIC PTE. LTD.

438B Alexandra Road, #08-01/02 Alexandra
Technopark, Singapore 119968
Tel: (65) 6835-3011 Fax: (65) 6835-3011

OMRON (CHINA) CO., LTD.

Room 2211, Bank of China Tower,
200 Yin Cheng Zhong Road,
PuDong New Area, Shanghai, 200120, China
Tel: (86) 21-6023-0333 Fax: (86) 21-5037-2388

Authorized Distributor:

©OMRON Corporation 1997-2024 All Rights Reserved.
In the interest of product improvement,
specifications are subject to change without notice.

CSM_2_2

Cat. No. L093-E1-06 0524 (1197)