



S50/S51

Extended range of standard “One for All” photoelectric tubular M18 sensors

- All optic functions and LASER models
- M18 flat plastic with universal mounting
- Available in M18 metal housing
- Axial or radial optics, cable or connector
- Standard 4-wire NO-NC NPN or PNP output



SENSORS

APPLICATIONS

- Processing and Packaging machinery
- Conveyor lines, material handling
- Ceramics intralogistics
- Automated warehousing

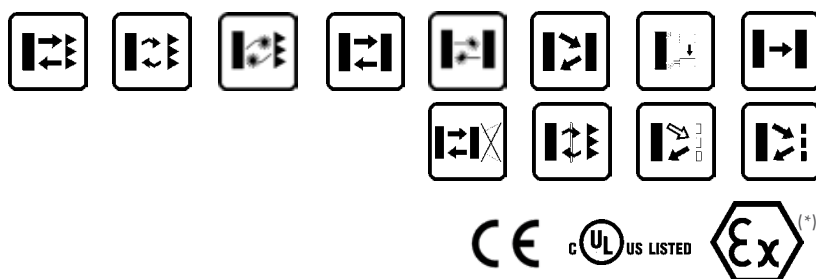

(*) Axial models.
ATEX II 3DG

S50/S51		
Through beam		0...20 m 0...60 m (class 1 LASER) (S50)
Retroreflective (on R2 reflector)		0,1...4 m
Polarized retroreflective		0,1...4 m (S50) 0,1...3 m (S51)
Retroreflective for transparent (on R2 reflector)		0,1...16 m (class 1 LASER) (S50) 0,1...1,3 m (S50)
Diffuse proximity		short distance 0...100 mm medium distance 0...400 mm (S50) 0...450 mm (S51) long distance 0...700 mm long distance LASER 0...350 mm
Fixed focus		100 mm (S50)
Background suppression		50...100 mm (S50)
Through beam with fiber optic		0...100 mm (S50)
Diffuse proximity with fiber optic		0...30 mm (S50)
Contrast sensor		10 ±2 mm
Luminescence sensor		0...20 mm
Power supply	Vdc	10...30 V
	Vac	
	Vac/dc	
Output	PNP	▪
	NPN	▪
	NPN/PNP	
	relay	
	other	
Connection	cable	▪
	connector	▪
	pig-tail	
Approximate dimensions (mm)		M18x 55/68
Housing material		PBT, nickel plated brass
Mechanical protection		IP67

TECHNICAL DATA	
Power supply	10 ... 30 Vdc (limit values)
Ripple	2 Vpp max.
Consumption (output current excluded)	35 mA max. (mod. S50...A00/B01/C01/C10/C21/D00/E01/T01) 30 mA max. (mod. S50...F01/M03, S51...A00/B01/C01/C10/C20/F00) 25 mA max. (mod. S50...W03/U03)
Light emission	red LED 630 nm (mod. S50...D00/E01, S50-PA/MA...M03) red LED 660 nm (mod. S50...B01/T01, S51...B01) red LED 670 nm (mod. S50-PS/MS...M03) IR LED 880 nm (mod. S50/S51...A00/C01/C10/C20/C21/G00) white LED 400-700 nm (mod. S50...W03) UV LED 370 nm (mod. S50...U03) red Laser 650 nm (mod. S50...G00/F01/B01/C01)
Setting	sensitivity trimmer (mod. B01/C01/C21/E01/F01/T01) teach-in push-button (mod. M03/W03/U03)
Operating mode	LIGHT mode on N.O. output / DARK mode on N.C. output (mod.S50...C01/C10/C21/D00/M03/U03) DARK mode on N.O. output / LIGHT mode on N.C. output (mod.S50...A00/B01/E01/F01/T01/W03) white wire or pin 2 connected to +10...30V LIGHT mode/ to 0V DARK mode (mod. S51) white wire or pin 2 not connected LIGHT mode (mod. S51...C01/C10/C20)/ DARK mode (mod. S51...A00/B01/F00)
Indicators	yellow OUTPUT LED (S50, S51, excl. mod. G00) green STABILITY LED (mod. S50...B01/C01/C21/E01/F01), POWER LED (mod. S50...G00, S51) green/red READY/ERROR LED (mod. S50...M03/W03/U03)
Output	PNP or NPN; NO; NC (mod. S50)
Output current	100 mA max.
Saturation voltage	2 V max.
Response time	0,5 ms (mod. S50...A00/B01/T01/C10/C21/C01/D00/E01/U03) 2 ms (mod. S50...F01/G00) 1 ms (mod. S50...M03, S51...A00/B01/C01/C10/G00) 4 ms (mod. S51...F00) 100 µs (mod. S50...W03) 333 µs (Laser mod. S50)
Switching frequency	1 kHz (mod. S50...A00/B01/T01/C10/C21/C01/D00/E01/U03) 250 Hz (mod. S50...F01/G00) 500 Hz (mod. S50...M03, S51...A00/B01/C01/C10/G00) 120 Hz (mod. S51...F00) 5 kHz (mod. S50...W03) 1,5 kHz (Laser mod. S50)
Connection	2 m cable Ø 4 mm, M12 4-pole connector
Dielectric strength	500 Vac, 1 min between electronics and housing
Insulating resistance	>20 MΩ, 500 Vdc between electronics and housing
Electrical protection	class 2
Mechanical protection	IP67
Ambient light rejection	according to EN 60947-5-2
Vibrations	0,5 mm amplitude, 10 ... 55 Hz frequency, for every axis (EN60068-2-6)
Shock resistance	11 ms (30 G) 6 shock for every axis (EN60068-2-27)
Housing material	Plastic version PBT Metal version nickel plated brass
Lens material	PMMA
Operating temperature	-25 ... 55 °C (Laser mod.) -10 ... 50 °C
Storage temperature	-25 ... 70 °C
Weight	Plastic version 75 g max. cable vers. (90 g max. mod. M03), 25 g max. conn. vers. (40 g max. mod. M03) Metal version 110 g max. cable vers. (125 g max. mod. M03), 60 g max. conn. vers. (75 g max. mod. M03)

BACKGROUND SUPPRESSION AXIAL VERSION

PLASTIC

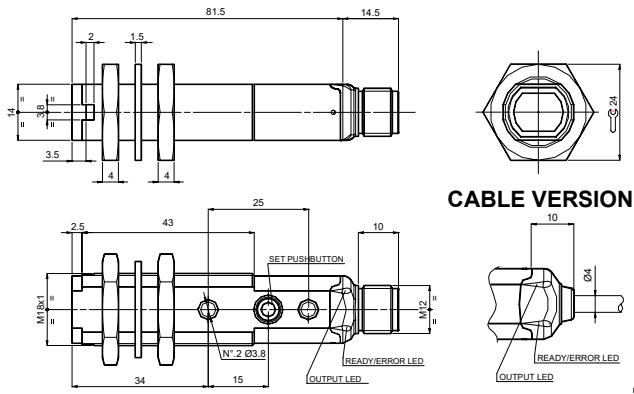

METAL

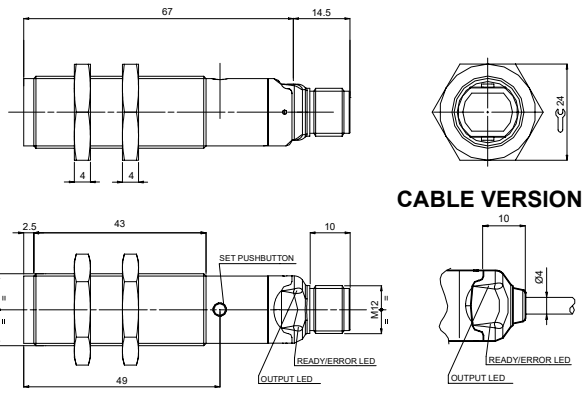

BACKGROUND SUPPRESSION RADIAL VERSION

PLASTIC

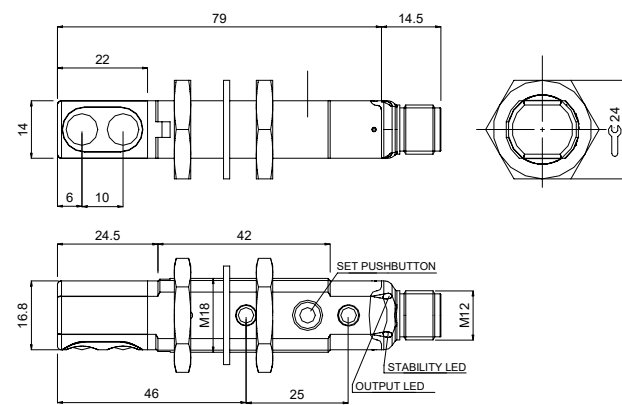

METAL

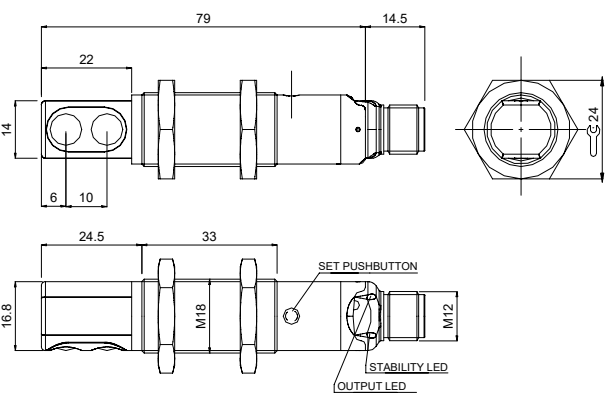

LUMINESCENCE AND CONTRAST

PLASTIC

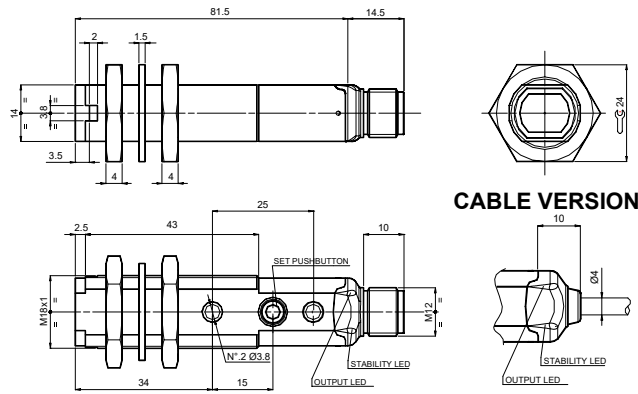

METAL

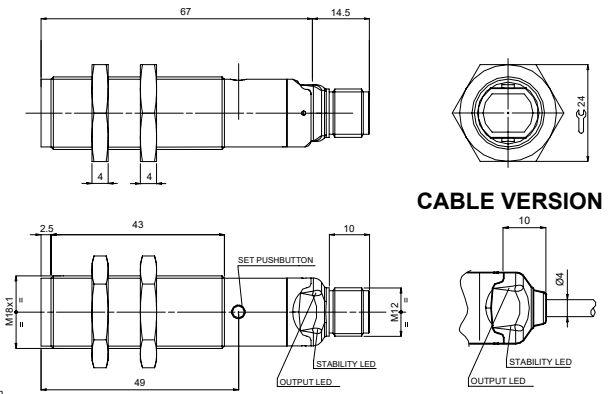

CONNECTIONS

CABLE

BROWN	1	+	10 ... 30 Vdc
WHITE	2		N.C. OUTPUT
BLACK	4		N.O. OUTPUT
BLUE	3	-	0 V

Through beam emitter

BROWN	1	+	10 ... 30 Vdc
WHITE	2		TEST +
BLACK	4		TEST / NOT USED (Laser version)
BLUE	3	-	0 V

M12 CONNECTOR

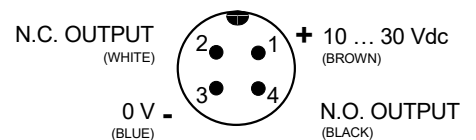

S51

DIMENSIONS

PLASTIC

AXIAL VERSION

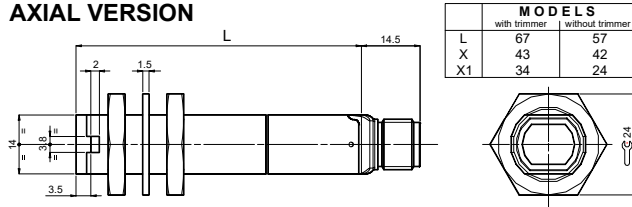

MODELS		
	with trimmer	without trimmer
L	67	57
X	43	42
X1	34	24

RADIAL VERSION

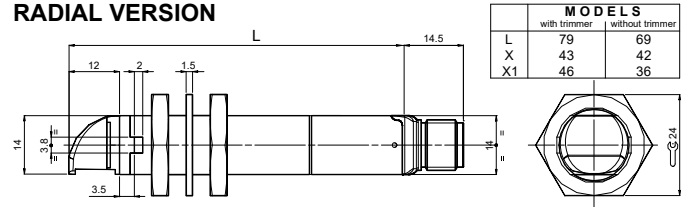

MODELS		
	with trimmer	without trimmer
L	79	69
X	43	42
X1	46	36

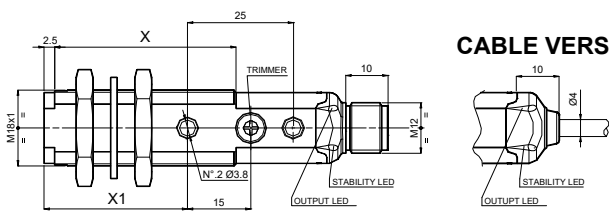

CABLE VERS.

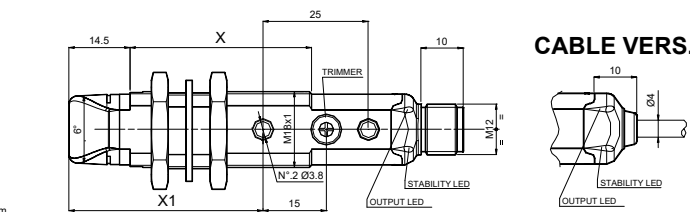

CABLE VERS.

CH.24 PLASTIC NUTS

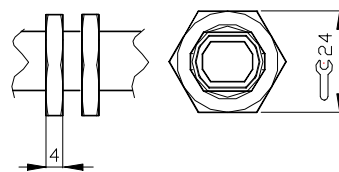

CH.22 PLASTIC NUTS

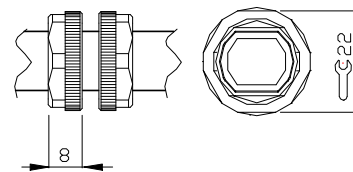

METAL

AXIAL VERSION

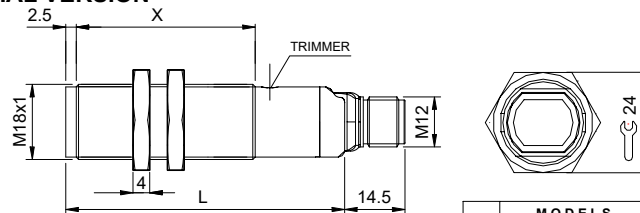

MODELS		
	B01/C01/F00	A00/C10/G00
L	67	57
X	43	38

RADIAL VERSION

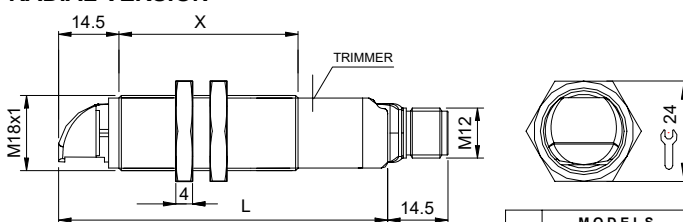

MODELS		
	B01/C01/F00	A00/C10/G00
L	79	69
X	43	38

CABLE VERSION

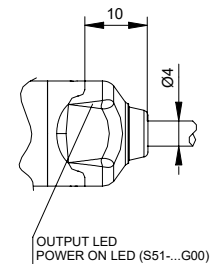

CONNECTIONS

CABLE

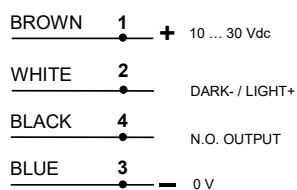

Through beam emitter

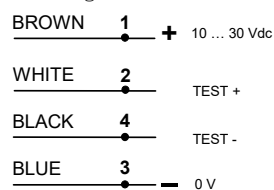

M12 CONNECTOR

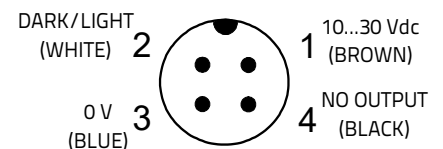

S50/S51

INDICATORS AND SETTINGS

S50-XX...A00/B01/C01/C21/E01/F01/T01
S51-XX...B01/C01

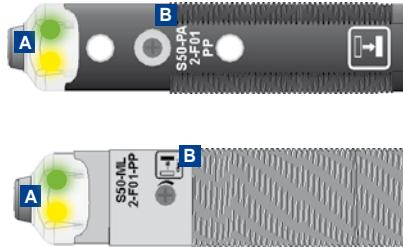

- A** OUTPUT status LED Yellow
STABILITY LED Green (Only Receiver)
POWER ON LED Green (Only Emitter)
- B** Adjustment trimmer (receiver)

Single-turn trimmer for sensitivity adjustment. Rotate in a clockwise direction to increase the operating distance.

S50-XX-M03/W03/U03

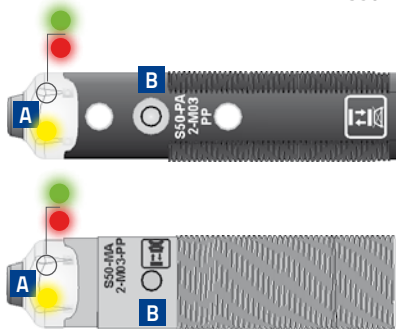

- A** OUTPUT status LED Yellow
READY LED Green
ERROR LED Red
- B** Teach-in push-button

Teach-in button for setting.
EASYtouch™ provides two setting modes: standard or fine, both obtained by pressing the push-button only once.
Please refer to instructions manual for operating details.

S50-XX-C10
S51-XX-A00/C10/C20/F00/G00

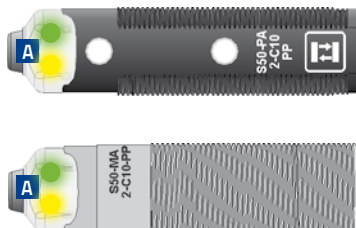

- A** A00/C10/C20/F00
OUTPUT status LED Yellow
STABILITY LED green
- G00
OUTPUT status LED yellow (Only Emitter G00)

S50 DETECTION DIAGRAMS

G/F INFRARED EMISSION

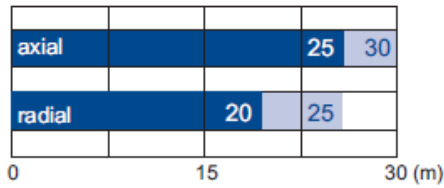

Recommended operating distance
 Maximum operating distance

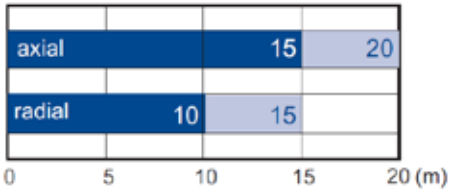
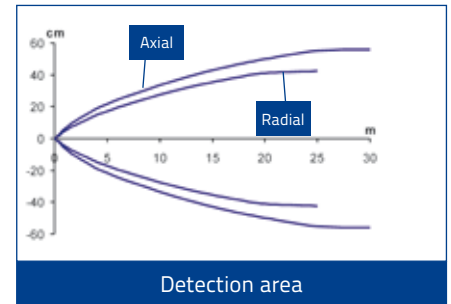
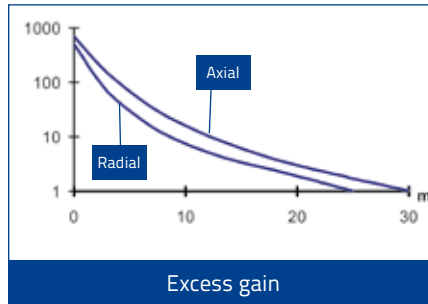

Recommended operating distance
 Maximum operating distance

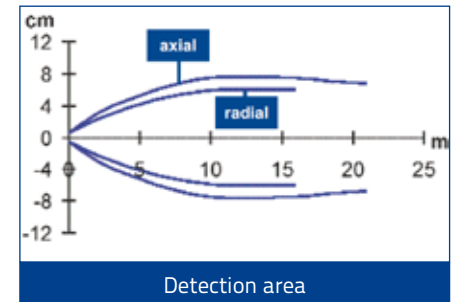
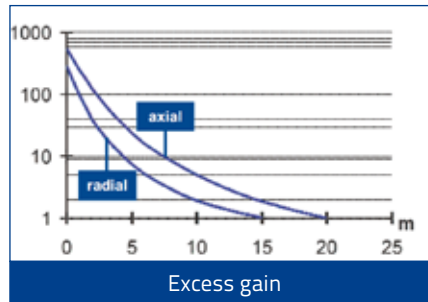

G/F LASER RED EMISSION



Operating distance

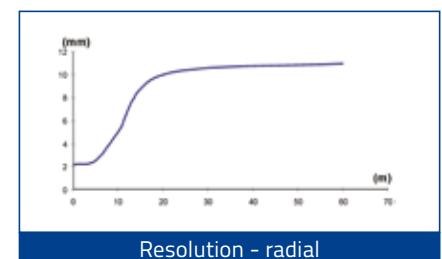
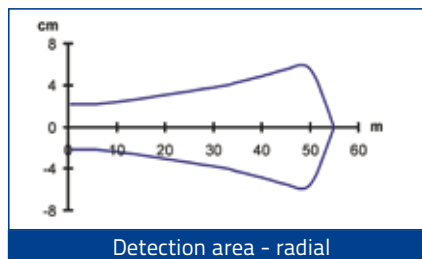
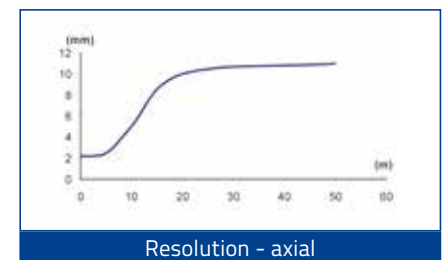
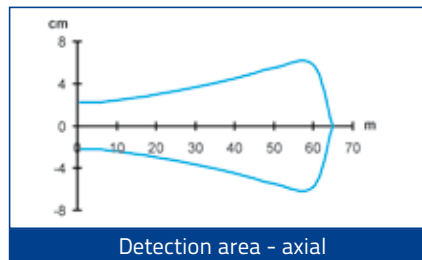

Operating distance

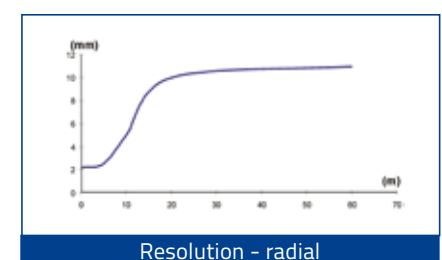
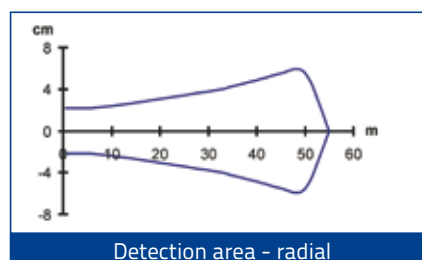
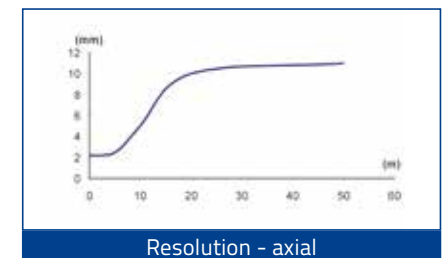
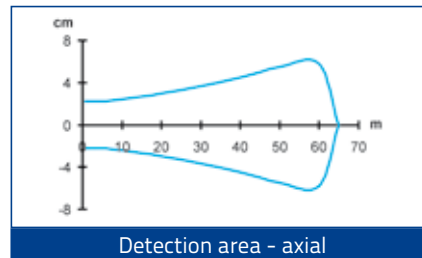

A INFRARED EMISSION

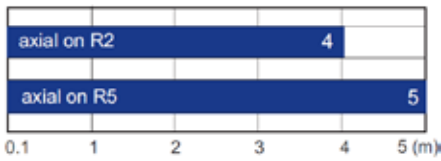

■ Operating distance

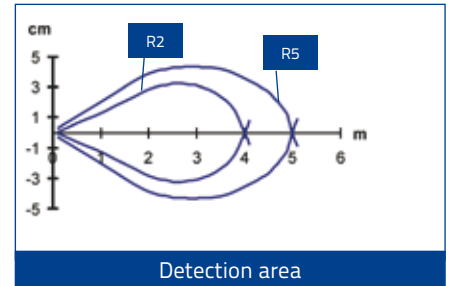
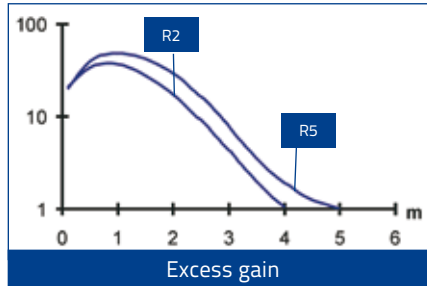

B RED EMISSION

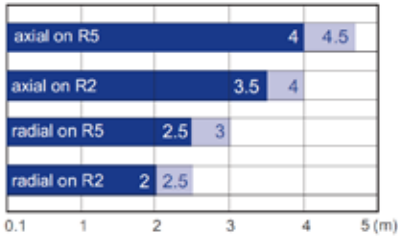

■ Recommended operating distance
 ■ Maximum operating distance

High efficiency reflectors can be used to obtain larger operating distances. Refer to **Reflectors** (A.01).

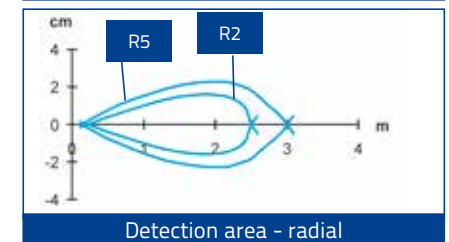
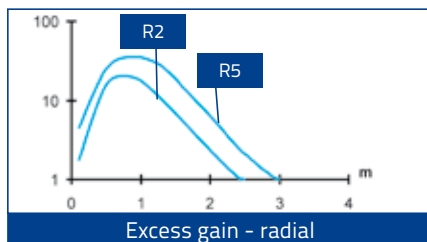
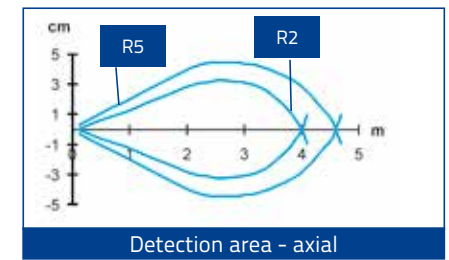
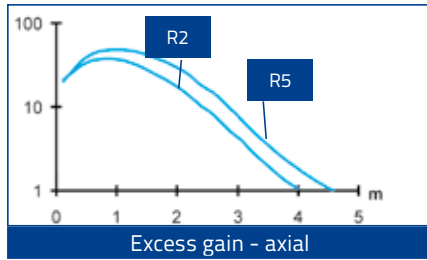

B LASER RED EMISSION

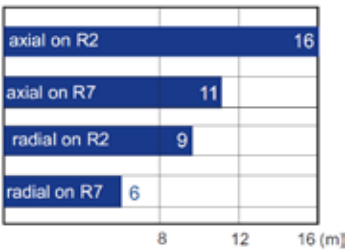

■ Operating distance

High efficiency reflectors can be used to obtain larger operating distances. Refer to **Reflectors** (A.01).

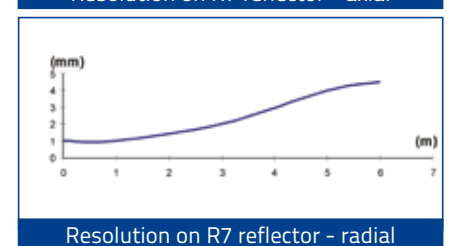
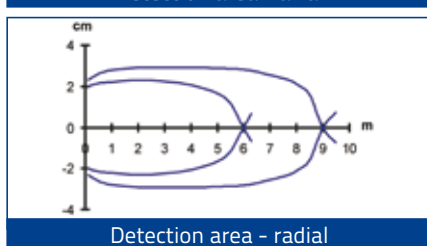
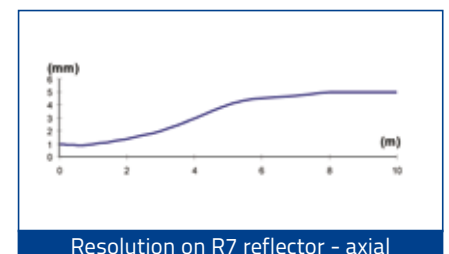
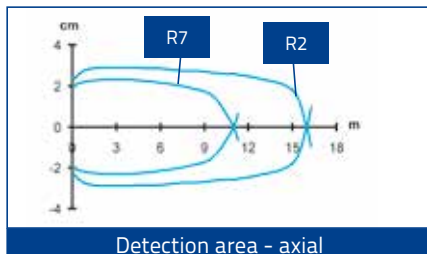

T RED EMISSION

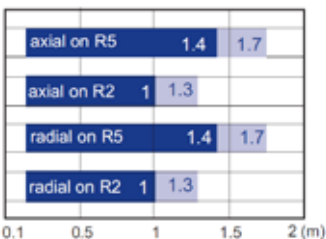

■ Recommended operating distance
 ■ Maximum operating distance

High efficiency reflectors can be used to obtain larger operating distances. Refer to **Reflectors**.

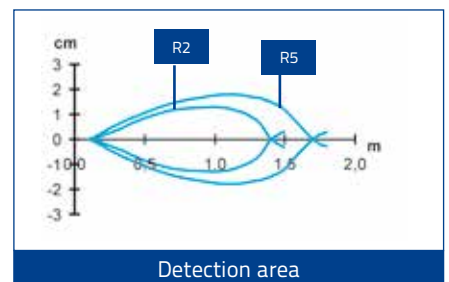
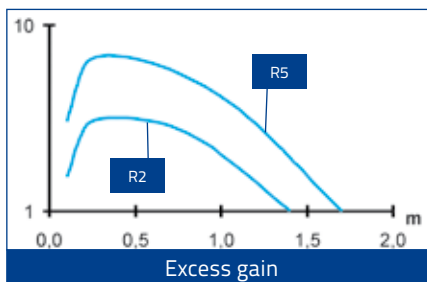

C SHORT INFRARED EMISSION



Recommended operating distance
 Maximum operating distance

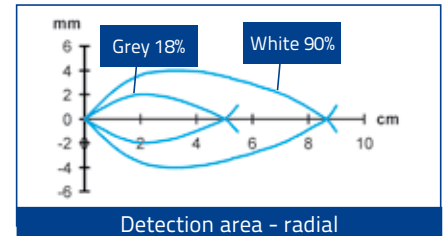
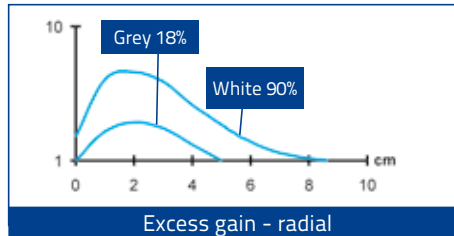
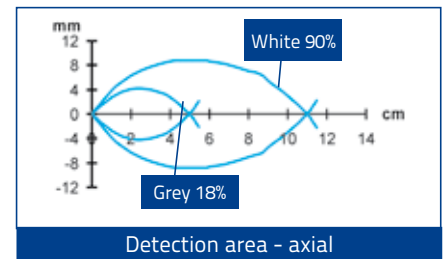
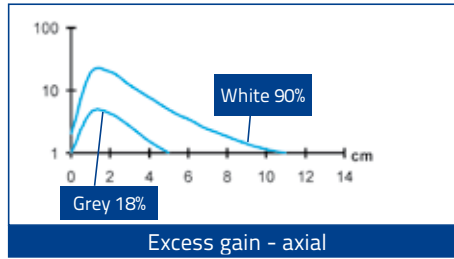

C MID INFRARED EMISSION

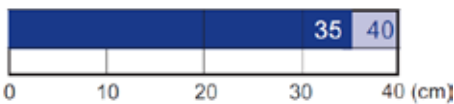

Recommended operating distance
 Maximum operating distance

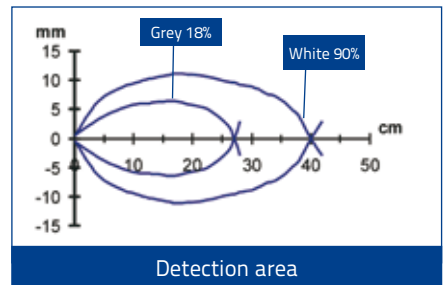
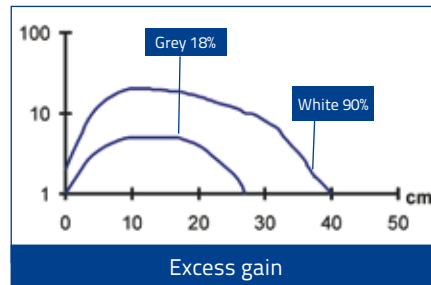

C LONG INFRARED EMISSION

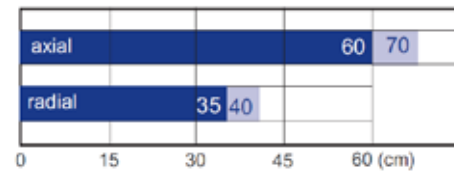

Recommended operating distance
 Maximum operating distance

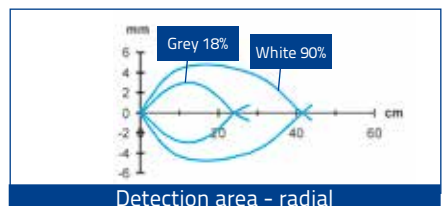
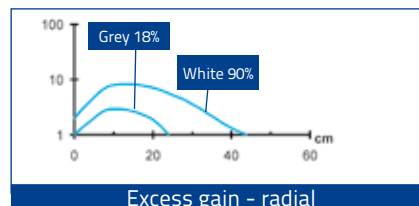
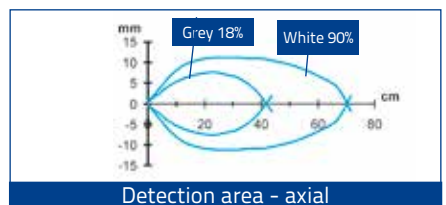
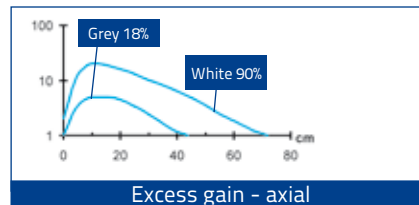

D RED EMISSION

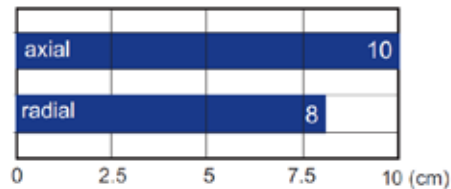

Operating distance

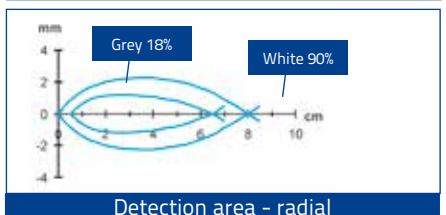
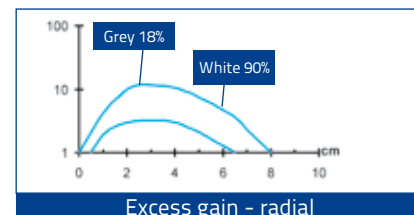
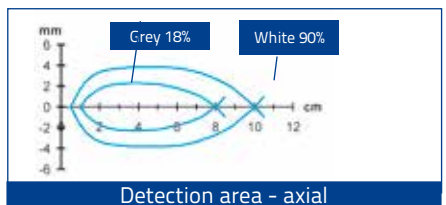
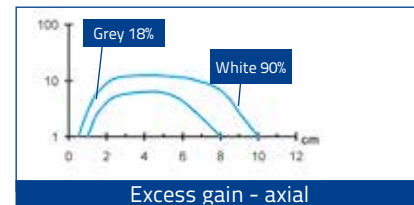

C LASER RED EMISSION

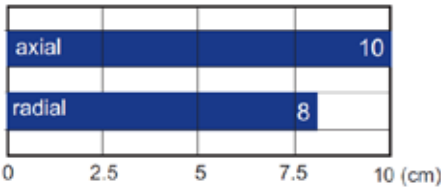

Operating distance

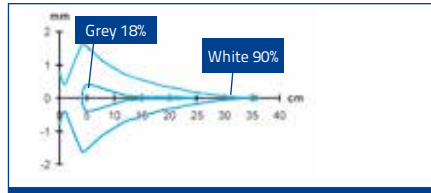

Detection area - axial

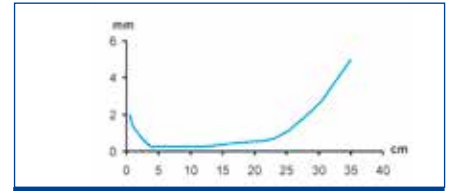

Resolution - axial

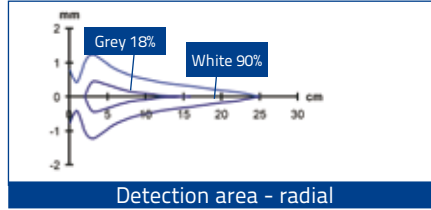

Detection area - radial

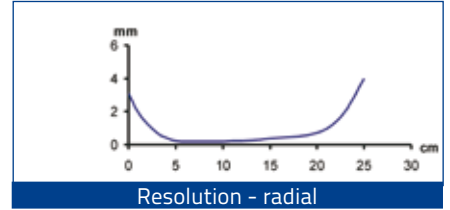

Resolution - radial

M AXIAL RED EMISSION

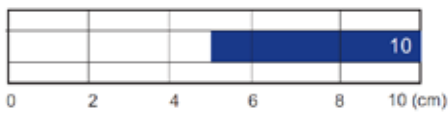

Operating distance

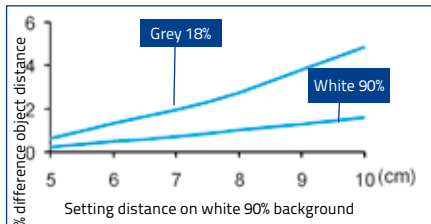

Detection difference with EASYtouch™ acquisition

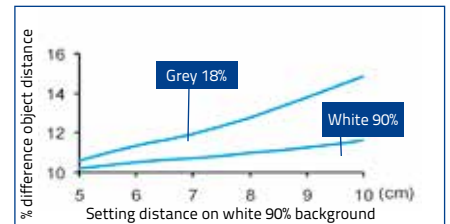

Detection difference with fine acquisition

M RADIAL RED EMISSION

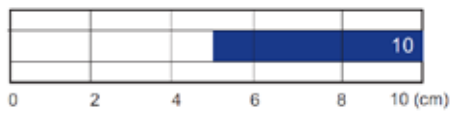

Operating distance

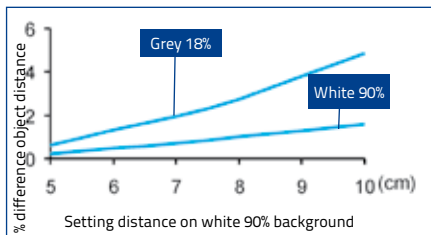

Detection difference with EASYtouch™ acquisition

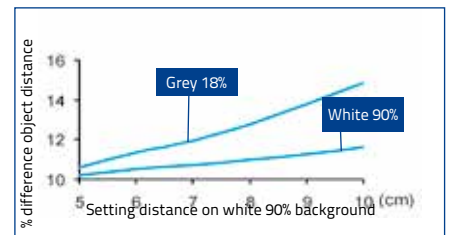

Detection difference with fine acquisition

E RED EMISSION

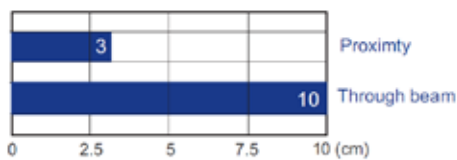

Operating distance with standard fibers

Standard Fiber-optics:
OF-42-ST-20 proximity
OF-43-ST-20 through beam

High efficiency fiber-optics or accessory lenses can be used to obtain larger operating distances.

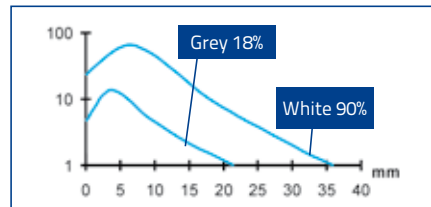

Excess gain - proximity *

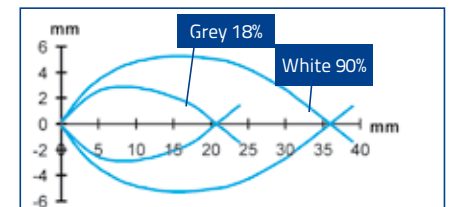

Detection area - proximity *

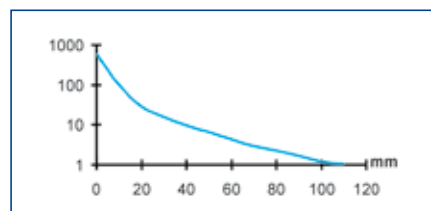

Excess gain - through beam *

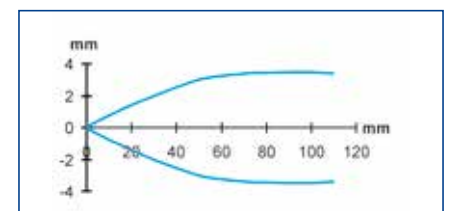

Detection area - through beam *

* standard Fiber-optics

W WHITE EMISSION

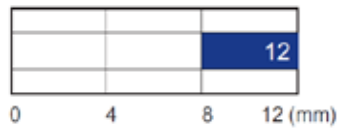

Operating distance

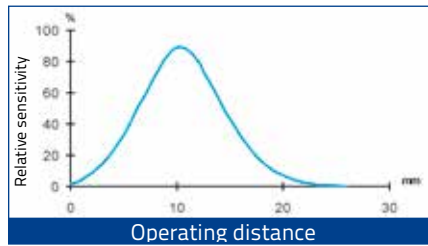

U UV EMISSION



Operating distance

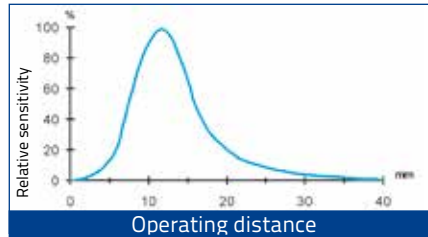

S51 DETECTION DIAGRAMS

M18 STANDARD

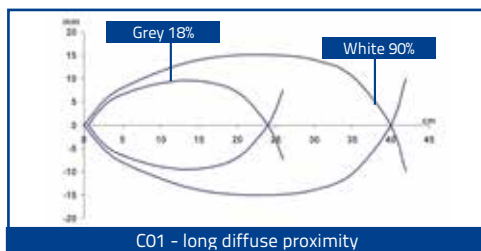

C01 - long diffuse proximity

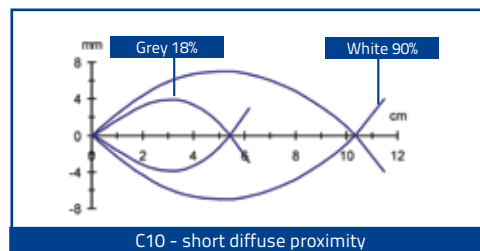

C10 - short diffuse proximity

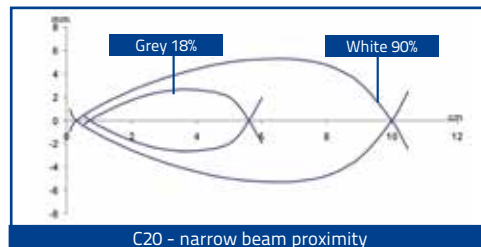

C20 - narrow beam proximity

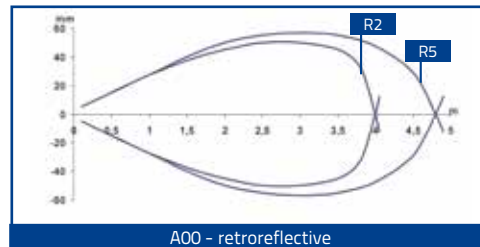

A00 - retroreflective

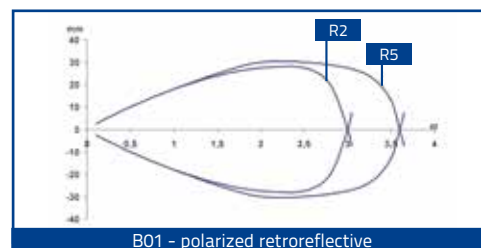

B01 - polarized retroreflective

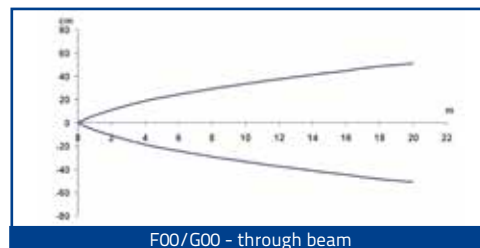

F00/G00 - through beam

Note: the diagrams indicate the detection area typical of the axial optic versions; the maximum operating distance of the radial optic versions decreases as indicated in the tables given below

A00	3,5	4
Axial on FD		
A00	4	4,5
Axial on FD		
A00	2,5	3
Radial on FD		
A00	3	3,5
Radial on FD		

C01	40	55
Radial		
C01	30	35
Radial		

B01	2,5	3
Radial on FD		
B01	3	3,5
Radial on FD		
B01	2	2,5
Radial on FD		
B01	2,5	3
Radial on FD		

C10/C20	10
Radial	
C10	8
Radial	

F/G	18	20
Radial		
F/G	15	18
Radial		

Recommended operating distance
Maximum operating distance

MODEL SELECTION AND ORDER INFORMATION

S50 PLASTIC MODELS					
OPTIC FUNCTION	EMISSION	CONNECTION	OUTPUT	MODEL	ORDER No.
Retroreflective	LED, Axial optic	2m Cable	NPN	S50-PA-2-A00-NN	952002090
			PNP	S50-PA-2-A00-PP	952002080
		M12 Connector	NPN	S50-PA-5-A00-NN	952002110
			PNP	S50-PA-5-A00-PP	952002100
Polarized retroreflective	LED, Axial optic	2m Cable	NPN	S50-PA-2-B01-NN	952001610
			PNP	S50-PA-2-B01-PP	952001010
		M12 Connector	NPN	S50-PA-5-B01-NN	952001500
			PNP	S50-PA-5-B01-PP	952001020
	LED, Radial optic	2m Cable	NPN	S50-PR-2-B01-NN	952001780
			PNP	S50-PR-2-B01-PP	952001030
		M12 Connector	NPN	S50-PR-5-B01-NN	952001720
			PNP	S50-PR-5-B01-PP	952001040
	LASER, Axial optic	2m Cable	NPN	S50-PL-2-B01-NN	952001870
			PNP	S50-PL-2-B01-PP	952001360
		M12 Connector	NPN	S50-PL-5-B01-NN	952001840
			PNP	S50-PL-5-B01-PP	952001370
	LASER, Radial optic	2m Cable	NPN	S50-PH-2-B01-NN	952001950
			PNP	S50-PH-2-B01-PP	952001940
		M12 Connector	NPN	S50-PH-5-B01-NN	952001970
			PNP	S50-PH-5-B01-PP	952001960
Long Diffuse proximity	LED, Axial optic	2m Cable	NPN	S50-PA-2-C01-NN	952001620
			PNP	S50-PA-2-C01-PP	952001050
		M12 Connector	NPN	S50-PA-5-C01-NN	952001510
			PNP	S50-PA-5-C01-PP	952001060
	LED, Radial optic	2m Cable	NPN	S50-PR-2-C01-NN	952001790
			PNP	S50-PR-2-C01-PP	952001070
		M12 Connector	NPN	S50-PR-5-C01-NN	952001730
			PNP	S50-PR-5-C01-PP	952001080
	LASER, Axial optic	2m Cable	NPN	S50-PL-2-C01-NN	952001880
			PNP	S50-PL-2-C01-PP	952001380
		M12 Connector	NPN	S50-PL-5-C01-NN	952001850
			PNP	S50-PL-5-C01-PP	952001390
	LASER, Radial optic	2m Cable	NPN	S50-PH-2-C01-NN	952001990
			PNP	S50-PH-2-C01-PP	952001980
		M12 Connector	NPN	S50-PH-5-C01-NN	952002010
			PNP	S50-PH-5-C01-PP	952002000
Short Diffuse proximity	LED, Axial optic	2m Cable	NPN	S50-PA-2-C10-NN	952001630
			PNP	S50-PA-2-C10-PP	952001240
		M12 Connector	NPN	S50-PA-5-C10-NN	952001520
			PNP	S50-PA-5-C10-PP	952001250
	LED, Radial optic	2m Cable	NPN	S50-PR-2-C10-NN	952001800
			PNP	S50-PR-2-C10-PP	952001490
		M12 Connector	NPN	S50-PR-5-C10-NN	952001740
			PNP	S50-PR-5-C10-PP	952001480
Medium Diffuse proximity	LED, Axial optic	2m Cable	NPN	S50-PA-2-C21-NN	952002170
			PNP	S50-PA-2-C21-PP	952002160
		M12 Connector	NPN	S50-PA-5-C21-NN	952002190
			PNP	S50-PA-5-C21-PP	952002180
Fixed focus	LED, Axial optic	2m Cable	NPN	S50-PA-2-D00-NN	952001640
			PNP	S50-PA-2-D00-PP	952001090
		M12 Connector	NPN	S50-PA-5-D00-NN	952001530
			PNP	S50-PA-5-D00-PP	952001100
	LED, Radial optic	2m Cable	NPN	S50-PR-2-D00-NN	952001810
			PNP	S50-PR-2-D00-PP	952001110
		M12 Connector	NPN	S50-PR-5-D00-NN	952001750
			PNP	S50-PR-5-D00-PP	952001120
Fiber optic	LED, Axial optic	2m Cable	NPN	S50-PA-2-E01-NN	952001650
			PNP	S50-PA-2-E01-PP	952001130
		M12 Connector	NPN	S50-PA-5-E01-NN	952001540
			PNP	S50-PA-5-E01-PP	952001140

OPTIC FUNCTION	EMISSION	CONNECTION	OUTPUT	MODEL	ORDER No.
Through beam receiver	LED, Axial optic	2m Cable	NPN	S50-PA-2-F01-NN	952001660
			PNP	S50-PA-2-F01-PP	952001150
		M12 Connector	NPN	S50-PA-5-F01-NN	952001550
			PNP	S50-PA-5-F01-PP	952001160
	LED, Radial optic	2m Cable	NPN	S50-PR-2-F01-NN	952001820
			PNP	S50-PR-2-F01-PP	952001170
		M12 Connector	NPN	S50-PR-5-F01-NN	952001760
			PNP	S50-PR-5-F01-PP	952001180
	LASER, Axial optic	2m Cable	NPN	S50-PL-2-F01-NN	952001890
			PNP	S50-PL-2-F01-PP	952001400
		M12 Connector	NPN	S50-PL-5-F01-NN	952001860
			PNP	S50-PL-5-F01-PP	952001410
LASER, Radial optic	2m Cable	NPN	S50-PH-2-F01-NN	952002030	
		PNP	S50-PH-2-F01-PP	952002020	
	M12 Connector	NPN	S50-PH-5-F01-NN	952002050	
		PNP	S50-PH-5-F01-PP	952002040	
Through beam emitter	LED, Axial optic	2m Cable	-	S50-PA-2-G00-XG	952001190
		M12 Connector	-	S50-PA-5-G00-XG	952001200
	LED, Radial optic	2m Cable	-	S50-PR-2-G00-XG	952001210
		M12 Connector	-	S50-PR-5-G00-XG	952001220
	LASER, Axial optic	2m Cable	-	S50-PL-2-G00-XG	952001420
		M12 Connector	-	S50-PL-5-G00-XG	952001430
	LASER, Radial optic	2m Cable	-	S50-PH-2-G00-XG	952002060
		M12 Connector	-	S50-PH-5-G00-XG	952002070
Background suppression	LED, Axial optic	2m Cable	NPN	S50-PA-2-M03-NN	952001670
			PNP	S50-PA-2-M03-PP	952001230
		M12 Connector	NPN	S50-PA-5-M03-NN	952001560
			PNP	S50-PA-5-M03-PP	952001000
	LED, Radial optic	2m Cable	NPN	S50-PS-2-M03-NN	952001900
		M12 Connector	PNP	S50-PS-2-M03-PP	952001910
Retroreflective for transparent	LED, Axial optic	2m Cable	NPN	S50-PA-2-T01-NN	952001690
			PNP	S50-PA-2-T01-PP	952001260
		M12 Connector	NPN	S50-PA-5-T01-NN	952001580
			PNP	S50-PA-5-T01-PP	952001270
	LED, Radial optic	2m Cable	NPN	S50-PR-2-T01-NN	952001830
			PNP	S50-PR-2-T01-PP	952001280
		M12 Connector	NPN	S50-PR-5-T01-NN	952001770
			PNP	S50-PR-5-T01-PP	952001290
Luminescence	LED, Axial optic	2m Cable	NPN	S50-PA-2-U03-NN	952001700
			PNP	S50-PA-2-U03-PP	952001300
		M12 Connector	NPN	S50-PA-5-U03-NN	952001590
			PNP	S50-PA-5-U03-PP	952001310
Contrast	LED, Axial optic	2m Cable	NPN	S50-PA-2-W03-NN	952001710
			PNP	S50-PA-2-W03-PP	952001320
		M12 Connector	NPN	S50-PA-5-W03-NN	952001600
			PNP	S50-PA-5-W03-PP	952001330

S50 METAL MODELS					
OPTIC FUNCTION	EMISSION	CONNECTION	OUTPUT	MODEL	ORDER No.
Retroreflective	LED, Axial optic	2m Cable	NPN	S50-MA-2-A00-NN	952022090
			PNP	S50-MA-2-A00-PP	952022080
		M12 Connector	NPN	S50-MA-5-A00-NN	952022110
			PNP	S50-MA-5-A00-PP	952022100
Polarized retroreflective	LED, Axial optic	2m Cable	NPN	S50-MA-2-B01-NN	952021500
			PNP	S50-MA-2-B01-PP	952021000
		M12 Connector	NPN	S50-MA-5-B01-NN	952021660
			PNP	S50-MA-5-B01-PP	952021200
	LED, Radial optic	2m Cable	NPN	S50-MR-2-B01-NN	952021600
			PNP	S50-MR-2-B01-PP	952021140
		M12 Connector	NPN	S50-MR-5-B01-NN	952021760
			PNP	S50-MR-5-B01-PP	952021340
	LASER, Axial optic	2m Cable	NPN	S50-ML-2-B01-NN	952021820
			PNP	S50-ML-2-B01-PP	952021400
		M12 Connector	NPN	S50-ML-5-B01-NN	952021850
			PNP	S50-ML-5-B01-PP	952021440
	LASER, Radial optic	2m Cable	NPN	S50-MH-2-B01-NN	952021950
			PNP	S50-MH-2-B01-PP	952021940
		M12 Connector	NPN	S50-MH-5-B01-NN	952021970
			PNP	S50-MH-5-B01-PP	952021960
Long Diffuse proximity	LED, Axial optic	2m Cable	NPN	S50-MA-2-C01-NN	952021510
			PNP	S50-MA-2-C01-PP	952021010
		M12 Connector	NPN	S50-MA-5-C01-NN	952021670
			PNP	S50-MA-5-C01-PP	952021210
	LED, Radial optic	2m Cable	NPN	S50-MR-2-C01-NN	952021610
			PNP	S50-MR-2-C01-PP	952021150
		M12 Connector	NPN	S50-MR-5-C01-NN	952021770
			PNP	S50-MR-5-C01-PP	952021350
	LASER, Axial optic	2m Cable	NPN	S50-ML-2-C01-NN	952021830
			PNP	S50-ML-2-C01-PP	952021410
		M12 Connector	NPN	S50-ML-5-C01-NN	952021860
			PNP	S50-ML-5-C01-PP	952021450
	LASER, Radial optic	2m Cable	NPN	S50-MH-2-C01-NN	952021990
			PNP	S50-MH-2-C01-PP	952021980
		M12 Connector	NPN	S50-MH-5-C01-NN	952022010
			PNP	S50-MH-5-C01-PP	952022000
Short Diffuse proximity	LED, Axial optic	2m Cable	NPN	S50-MA-2-C10-NN	952021520
			PNP	S50-MA-2-C10-PP	952021020
		M12 Connector	NPN	S50-MA-5-C10-NN	952021680
			PNP	S50-MA-5-C10-PP	952021220
	LED, Radial optic	2m Cable	NPN	S50-MR-2-C10-NN	952021620
			PNP	S50-MR-2-C10-PP	952021490
		M12 Connector	NPN	S50-MR-5-C10-NN	952021780
			PNP	S50-MR-5-C10-PP	952021480
Medium Diffuse proximity	LED, Axial optic	2m Cable	NPN	S50-MA-2-C21-NN	952022130
			PNP	S50-MA-2-C21-PP	952022120
		M12 Connector	NPN	S50-MA-5-C21-NN	952022150
			PNP	S50-MA-5-C21-PP	952022140
Fixed focus	LED, Axial optic	2m Cable	NPN	S50-MA-2-D00-NN	952021530
			PNP	S50-MA-2-D00-PP	952021030
		M12 Connector	NPN	S50-MA-5-D00-NN	952021690
			PNP	S50-MA-5-D00-PP	952021230
	LED, Radial optic	2m Cable	NPN	S50-MR-2-D00-NN	952021630
			PNP	S50-MR-2-D00-PP	952021160
		M12 Connector	NPN	S50-MR-5-D00-NN	952021790
			PNP	S50-MR-5-D00-PP	952021360
Fiber optic	LED, Axial optic	2m Cable	NPN	S50-MA-2-E01-NN	952021880
			PNP	S50-MA-2-E01-PP	952021040
			M12 Connector	NPN	S50-MA-5-E01-NN
		PNP		S50-MA-5-E01-PP	952021240

OPTIC FUNCTION	EMISSION	CONNECTION	OUTPUT	MODEL	ORDER No.
Through beam receiver	LED, Axial optic	2m Cable	NPN	S50-MA-2-F01-NN	952021540
		M12 Connector	PNP	S50-MA-2-F01-PP	952021050
	LED, Radial optic	2m Cable	NPN	S50-MA-5-F01-NN	952021700
			PNP	S50-MA-5-F01-PP	952021250
		M12 Connector	NPN	S50-MR-2-F01-NN	952021640
			PNP	S50-MR-2-F01-PP	952021170
	LASER, Axial optic	2m Cable	NPN	S50-MR-5-F01-NN	952021800
			PNP	S50-MR-5-F01-PP	952021370
		M12 Connector	NPN	S50-ML-2-F01-NN	952021840
			PNP	S50-ML-2-F01-PP	952021420
	LASER, Radial optic	2m Cable	NPN	S50-ML-5-F01-NN	952021870
			PNP	S50-ML-5-F01-PP	952021460
M12 Connector		NPN	S50-MH-2-F01-NN	952022030	
		PNP	S50-MH-2-F01-PP	952022020	
M12 Connector		NPN	S50-MH-5-F01-NN	952022050	
		PNP	S50-MH-5-F01-PP	952022040	
Through beam emitter	LED, Axial optic	2m Cable	-	S50-MA-2-G00-XG	952021060
		M12 Connector	-	S50-MA-5-G00-XG	952021260
	LED, Radial optic	2m Cable	-	S50-MR-2-G00-XG	952021180
		M12 Connector	-	S50-MR-5-G00-XG	952021380
	LASER, Axial optic	2m Cable	-	S50-ML-2-G00-XG	952021430
		M12 Connector	-	S50-ML-5-G00-XG	952021470
	LASER, Radial optic	2m Cable	-	S50-MH-2-G00-XG	952022060
		M12 Connector	-	S50-MH-5-G00-XG	952022070
Background suppression	LED, Axial optic	2m Cable	NPN	S50-MA-2-M03-NN	952021550
		M12 Connector	PNP	S50-MA-2-M03-PP	952021070
	LED, Radial optic	2m Cable	PNP	S50-MA-5-M03-PP	952021270
		M12 Connector	PNP	S50-MS-2-M03-PP	952021910
Retroreflective for transparent	LED, Axial optic	2m Cable	NPN	S50-MS-5-M03-PP	952021930
			PNP	S50-MA-2-T01-NN	952021570
		M12 Connector	NPN	S50-MA-2-T01-PP	952021090
			PNP	S50-MA-5-T01-NN	952021730
	LED, Radial optic	2m Cable	NPN	S50-MA-5-T01-PP	952021290
			PNP	S50-MR-2-T01-NN	952021650
		M12 Connector	NPN	S50-MR-2-T01-PP	952021190
			PNP	S50-MR-5-T01-NN	952021810
M12 Connector	NPN	S50-MR-5-T01-PP	952021390		
	PNP	S50-MA-5-U03-PP	952021300		
Luminescence	LED, Axial optic	M12 Connector	PNP	S50-MA-5-U03-PP	952021300
Contrast	LED, Axial optic	2m Cable	PNP	S50-MA-2-W03-PP	952021110
		M12 Connector	NPN	S50-MA-5-W03-NN	952021750
			PNP	S50-MA-5-W03-PP	952021310

S51 MODELS

OPTIC FUNCTION	HOUSING/OPTIC	CONNECTION	OUTPUT	MODEL	ORDER No.
Retroreflective	Nickel Plated Brass, Axial	2m Cable	NPN	S51-MA-2-A00-NK	952701601
			PNP	S51-MA-2-A00-PK	952701541
		M12 Connector	NPN	S51-MA-5-A00-NK	952701801
			PNP	S51-MA-5-A00-PK	952701531
	Nickel Plated Brass, Radial	2m Cable	NPN	S51-MR-2-A00-NK	952701711
			PNP	S51-MR-2-A00-PK	952701651
		M12 Connector	NPN	S51-MR-5-A00-NK	952701911
			PNP	S51-MR-5-A00-PK	952701851
	Plastic, Axial	2m Cable	NPN	S51-PA-2-A00-NK	952701071
			PNP	S51-PA-2-A00-PK	952701001
		M12 Connector	NPN	S51-PA-5-A00-NK	952701331
			PNP	S51-PA-5-A00-PK	952701261
	Plastic, Radial	2m Cable	NPN	S51-PR-2-A00-NK	952701201
			PNP	S51-PR-2-A00-PK	952701131
		M12 Connector	NPN	S51-PR-5-A00-NK	952701461
			PNP	S51-PR-5-A00-PK	952701391

OPTIC FUNCTION	HOUSING/OPTIC	CONNECTION	OUTPUT	MODEL	ORDER No.
Polarized retroreflective	Nickel Plated Brass, Axial	2m Cable	NPN	S51-MA-2-B01-NK	952701611
			PNP	S51-MA-2-B01-PK	952701551
		M12 Connector	NPN	S51-MA-5-B01-NK	952701811
			PNP	S51-MA-5-B01-PK	952701761
	Nickel Plated Brass, Radial	2m Cable	NPN	S51-MR-2-B01-NK	952701721
			PNP	S51-MR-2-B01-PK	952701661
		M12 Connector	NPN	S51-MR-5-B01-NK	952701921
			PNP	S51-MR-5-B01-PK	952701861
	Plastic, Axial	2m Cable	NPN	S51-PA-2-B01-NK	952701081
			PNP	S51-PA-2-B01-PK	952701011
		M12 Connector	NPN	S51-PA-5-B01-NK	952701341
			PNP	S51-PA-5-B01-PK	952701271
Plastic, Radial	2m Cable	NPN	S51-PR-2-B01-NK	952701211	
		PNP	S51-PR-2-B01-PK	952701141	
	M12 Connector	NPN	S51-PR-5-B01-NK	952701471	
		PNP	S51-PR-5-B01-PK	952701401	
Medium diffuse proximity	Nickel Plated Brass, Axial	2m Cable	NPN	S51-MA-2-C01-NK	952701621
			PNP	S51-MA-2-C01-PK	952701561
		M12 Connector	NPN	S51-MA-5-C01-NK	952701821
			PNP	S51-MA-5-C01-PK	952701771
	Nickel Plated Brass, Radial	2m Cable	NPN	S51-MR-2-C01-NK	952701731
			PNP	S51-MR-2-C01-PK	952701671
		M12 Connector	NPN	S51-MR-5-C01-NK	952701931
			PNP	S51-MR-5-C01-PK	952701871
	Plastic, Axial	2m Cable	NPN	S51-PA-2-C01-NK	952701091
			PNP	S51-PA-2-C01-PK	952701021
		M12 Connector	NPN	S51-PA-5-C01-NK	952701351
			PNP	S51-PA-5-C01-PK	952701281
Plastic, Radial	2m Cable	NPN	S51-PR-2-C01-NK	952701221	
		PNP	S51-PR-2-C01-PK	952701151	
	M12 Connector	NPN	S51-PR-5-C01-NK	952701481	
		PNP	S51-PR-5-C01-PK	952701411	
Short diffuse proximity	Nickel Plated Brass, Axial	2m Cable	NPN	S51-MA-2-C10-NK	952701631
			PNP	S51-MA-2-C10-PK	952701571
		M12 Connector	NPN	S51-MA-5-C10-NK	952701831
			PNP	S51-MA-5-C10-PK	952701521
	Nickel Plated Brass, Radial	2m Cable	NPN	S51-MR-2-C10-NK	952701741
			PNP	S51-MR-2-C10-PK	952701681
		M12 Connector	NPN	S51-MR-5-C10-NK	952701941
			PNP	S51-MR-5-C10-PK	952701881
	Plastic, Axial	2m Cable	NPN	S51-PA-2-C10-NK	952701101
			PNP	S51-PA-2-C10-PK	952701031
		M12 Connector	NPN	S51-PA-5-C10-NK	952701361
			PNP	S51-PA-5-C10-PK	952701291
Plastic, Radial	2m Cable	NPN	S51-PR-2-C10-NK	952701231	
		PNP	S51-PR-2-C10-PK	952701161	
	M12 Connector	NPN	S51-PR-5-C10-NK	952701491	
		PNP	S51-PR-5-C10-PK	952701421	
Through beam receiver	Nickel Plated Brass, Axial	2m Cable	NPN	S51-MA-2-F00-NK	952701641
			PNP	S51-MA-2-F00-PK	952701581
		M12 Connector	NPN	S51-MA-5-F00-NK	952701841
			PNP	S51-MA-5-F00-PK	952701781
	Nickel Plated Brass, Radial	2m Cable	NPN	S51-MR-2-F00-NK	952701751
			PNP	S51-MR-2-F00-PK	952701691
		M12 Connector	NPN	S51-MR-5-F00-NK	952701951
			PNP	S51-MR-5-F00-PK	952701891
	Plastic, Axial	2m Cable	NPN	S51-PA-2-F00-NK	952701121
			PNP	S51-PA-2-F00-PK	952701051
		M12 Connector	NPN	S51-PA-5-F00-NK	952701381
			PNP	S51-PA-5-F00-PK	952701311
Plastic, Radial	2m Cable	NPN	S51-PR-2-F00-NK	952701251	
		PNP	S51-PR-2-F00-PK	952701181	
	M12 Connector	NPN	S51-PR-5-F00-NK	952701511	
		PNP	S51-PR-5-F00-PK	952701441	
Through beam emitter	Nickel Plated Brass, Axial	2m Cable	-	S51-MA-2-G00-XG	952701591
		M12 Connector	-	S51-MA-5-G00-XG	952701791
	Nickel Plated Brass, Radial	2m Cable	-	S51-MR-2-G00-XG	952701701
		M12 Connector	-	S51-MR-5-G00-XG	952701901
	Plastic, Axial	2m Cable	-	S51-PA-2-G00-XG	952701061
		M12 Connector	-	S51-PA-5-G00-XG	952701321
Plastic, Radial	2m Cable	-	S51-PR-2-G00-XG	952701191	
	M12 Connector	-	S51-PR-5-G00-XG	952701451	

S50/S51

ACCESSORIES

ST-5010

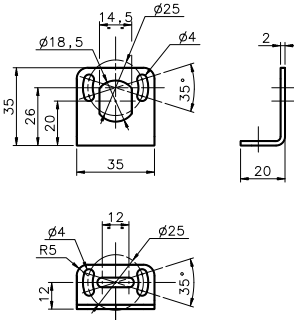

ST-5011

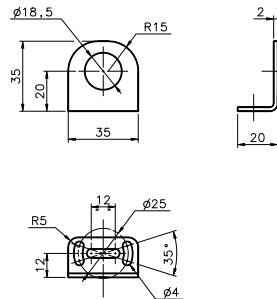

ST-5012

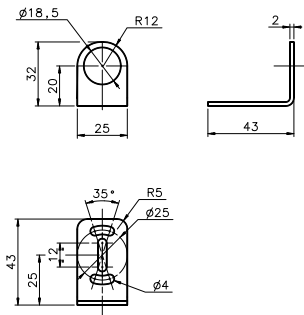

ST-5017

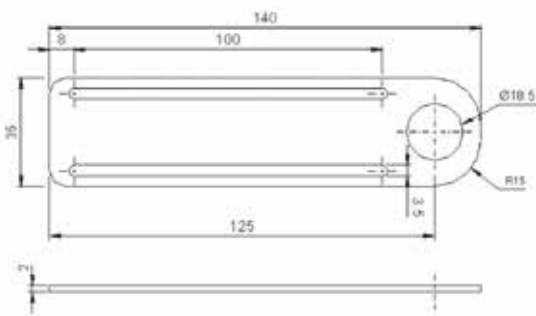

SWING-18

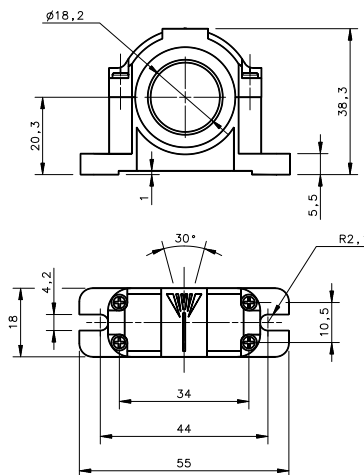

PLASTIC NUT

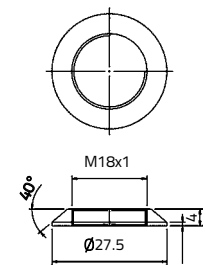

SP-40

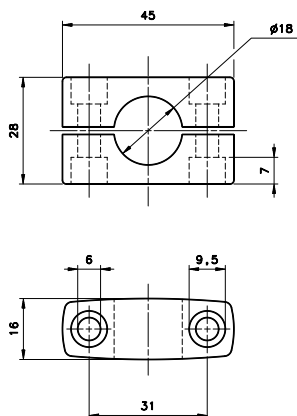

JOINT 18

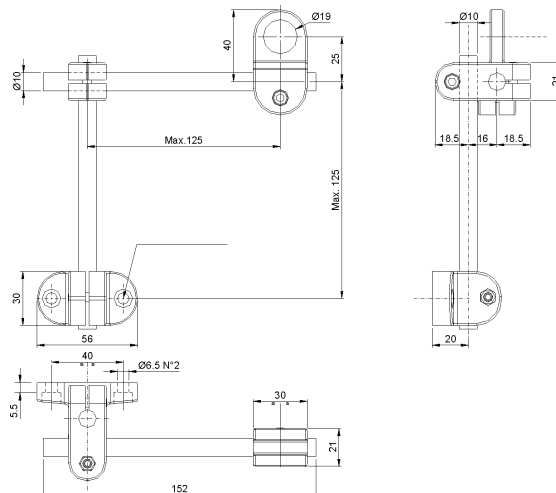

MICRO 18

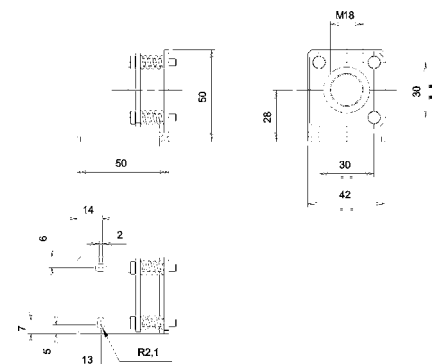

mm

MODEL	DESCRIPTION	ORDER No.
ST-5010	M18/14 mounting bracket	95ACC5230
ST-5011	M18 mounting bracket short	95ACC5240
ST-5012	M18 mounting bracket long	95ACC5250
ST-5017	M18 mounting bracket	95ACC5270
S50 EASY -IN	M18/14 EASY in™ adjustable mounting support	95ACC 5300
JOINT -18	M18 jointed support	95ACC 5220
MICRO -18	support with micrometric regulation for tubular M18 sensors	95ACC 1380
ST1218	M12/M18 mounting brackets	95ACC3340
ST1830	M18/M30 mounting brackets	95ACC3350
SP-40	mounting bracket tubular	95ACC1370
SWING-18	adjustable support for M18 tubular sensors	895000006
PLASTIC NUT	flared mounting nut	95ACC2630
MEK -PROOF	front protection (only for metal models)	G5000001

CABLES

TYPE	DESCRIPTION	LENGTH	MODEL	ORDER No.
Axial M12 Connector	4-pole, grey, P.V.C.	3 m	CS-A1-02-G-03	95A251380
		5 m	CS-A1-02-G-05	95A251270
		7 m	CS-A1-02-G-07	95A251280
		10 m	CS-A1-02-G-10	95A251390
Radial M12 Connector	4-pole, P.U.R.	2 m	CS-A1-02-R-02	95A251540
		5 m	CS-A1-02-R-05	95A251560
		10 m	CS-A1-02-R-10	95A251560
Radial M12 Connector	4-pole, grey, P.V.C.	3 m	CS-A2-02-G-03	95A251360
		5 m	CS-A2-02-G-05	95A251240
		7 m	CS-A2-02-G-07	95A251245
		10 m	CS-A2-02-G-10	95A251260
Radial M12 Connector with LED (for PNP N.O. sensors)	4-pole, P.U.R.	2 m	CS-A2-02-R-02	95A251550
		5 m	CS-A2-02-R-05	95A251570
Radial M12 Connector with LED (for PNP N.O. sensors)	4-pole, grey, P.V.C.	3 m	CS-A2-12-G-03	95A251400
		5 m	CS-A2-12-G-05	95A251350
		10 m	CS-A2-12-G-10	95A251370
Axial M12 Connector	4-pole, shielded, black, P.V.C.	3 m	CV-A1-22-B-03	95ACC1480
		5 m	CV-A1-22-B-05	95ACC1490
		10 m	CV-A1-22-B-10	95ACC1500
		15 m	CV-A1-22-B-15	95ACC2070
		25 m	CV-A1-22-B-25	95ACC2090
Radial M12 Connector	4-pole, shielded, black, P.V.C.	3 m	CV-A2-22-B-03	95ACC1540
		5 m	CV-A2-22-B-05	95ACC1550
		10 m	CV-A2-22-B-10	95ACC1560
Axial M12 Connector	4-pole, U.L., black, P.V.C.	3 m	CS-A1-02-U-03	95ASE1120
		5 m	CS-A1-02-U-05	95ASE1130
		10 m	CS-A1-02-U-10	95ASE1140
		15 m	CS-A1-02-U-15	95ASE1150
		25 m	CS-A1-02-U-25	95ASE1160
Radial M12 Connector	4-pole, black	Connector- not cabled	CS-A1-02-B-NC	G5085002
		Connector- not cabled	CS-A2-02-B-NC	G5085003