



Operating Instructions

Modbus RTU



VLT® 2800

VLT® 6000

VLT® 8000

■ Contents

Overview	6
Introduction	6
About This Manual	6
Assumptions	6
What You Should Already Know	6
Modbus RTU Overview	6
VLT 2800, VLT 6000 and VLT 8000 with Modbus RTU	7
 Installation and Setup	 8
Network Connection	8
Hardware Setup VLT 2800	9
Hardware Setup VLT 6000 and VLT 8000	9
EMC Precautions	9
 Modbus RTU Programming	 10
VLT 2800 Parameter Settings for Modbus Communication	10
VLT 6000 Parameter Settings for Modbus Communication	12
Installation and Set-up VLT 8000	13
VLT 8000 Parameter Settings for Modbus Communication	13
 Network Configuration	 14
Remote Terminal Unit	14
Modbus RTU Message Framing Structure	14
 Parameter Handling	 16
Parameter Handling	16
Storage of Data	16
Register Maps VLT 2800	17
Register Maps VLT 6000	18
Register Maps VLT 8000	19
Process Data	20
Status Coil Maps	20
Control Word Bit Descriptions for VLT 2800	20
Status Word Bit Description for VLT 2800	21
Control Word Bit Descriptions VLT 6000 / VLT 8000	23
Status Word Bit Descriptions VLT 6000 / VLT 8000	25
Serial communication reference	26
Present output frequency	26
 Supported Modbus RTU Function Codes	 28
 Exception Codes	 31
Exception Code Tables	31
 Appendix A - Examples	 32

■ Software Version VLT 2800, VLT 6000 and VLT 8000

VLT 2800 Series

Operating instructions
Software version: 2.8x



  

These operating instructions can be used for all VLT 2800 Series frequency converters with software version 2.8x. The software version number can be seen from parameter 640 Software version no.

195NA009.17

VLT 6000 HVAC

Operating Instructions
Software version: 3.0x



These Operating Instructions can be used for all VLT 6000 HVAC frequency converters with software version 3.0x. The software version number can be seen from parameter 624.

175ZA691.14

VLT 8000 AQUA

Operating Instructions

Software version: 1.5x

These Operating Instructions can be used for all VLT 8000 AQUA frequency converters with software version 1.5x. The software version number can be seen from parameter 624 *Software version no.*

176FA145.13

Safety - Modbus RTU

High Voltage Warning



Rotating shafts and electrical equipment can be hazardous. Therefore, it is strongly recommended that all electrical work conform to National Electrical Code (NEC) and all local regulations. Installation, start-up and maintenance should be performed only by qualified personnel.

Motor control equipment and electronic controls are connected to hazardous line voltages. When servicing

frequency converters and electronic controls, there will be exposed components at or above line potential. Extreme care should be taken to protect against shock. Stand on an insulating pad and make it a habit to use only one hand when checking components. Always work with another person in case of an emergency. Disconnect power whenever possible to check controls or to perform maintenance. Be sure equipment is properly grounded. Wear safety glasses whenever working on electric control or rotating equipment.

Warnings Against Unintended Start

1. While the frequency converter is connected to the AC line, the motor can be brought to a stop by means of external switch closures, serial bus commands or references. If personal safety considerations make it necessary to ensure that no unintended start occurs, these stops are not sufficient.
2. During programming of parameters, the motor may start. Be certain that no one is in the area of the motor or frequency converter driven equipment when changing parameters
3. A motor that has been stopped may start unexpectedly if faults occur in the electronics of the frequency converter, or if an overload, a fault in the supply AC line or a fault in the motor connection or other fault clears.
4. If the "Local/Hand" key is activated, the motor can only be brought to a stop by means of the "Stop/Off" key or an external safety interlock.

Electrostatic discharge (ESD)



Electronic components are sensitive to electrostatic discharge (ESD). ESD can reduce performance or destroy sensitive electronic components. Follow proper ESD procedures during installation or servicing to prevent damage.

VLT 2800



Warning:

It can be extremely dangerous to touch the electrical parts even when the mains supply has been disconnected.

Also ensure that other voltage inputs are disconnected from load sharing through the DC bus.

Wait at least 4 minutes after the input power has been removed before servicing the drive.

195NA139.10

VLT 6000 HVAC



Warning:

Touching the electrical parts may be fatal - even after the equipment has been disconnected from mains.

Using VLT 6002 - 6005, 200-240 V: Wait at least 4 minutes

Using VLT 6006 - 6062, 200-240 V: Wait at least 15 minutes

Using VLT 6002 - 6005, 380-460 V: Wait at least 4 minutes

Using VLT 6006 - 6072, 380-460 V: Wait at least 15 minutes

Using VLT 6102 - 6352, 380-460 V: Wait at least 20 minutes

Using VLT 6400 - 6550, 380-460 V: Wait at least 15 minutes

Using VLT 6002 - 6006, 525-600 V: Wait at least 4 minutes

Using VLT 6008 - 6027, 525-600 V: Wait at least 15 minutes

Using VLT 6032 - 6275, 525-600 V: Wait at least 30 minutes

175HA490.11

VLT 8000 AQUA



Warning:

Touching the electrical parts may be fatal - even after the equipment has been disconnected from line.

VLT 8006-8062, 200-240 V:	wait at least 15 minutes
VLT 8006-8072, 380-480 V:	wait at least 15 minutes
VLT 8102-8352, 380-480 V:	wait at least 20 minutes
VLT 8450-8600, 380-480 V:	wait at least 15 minutes
VLT 8002-8006, 525-600 V:	wait at least 4 minutes
VLT 8008-8027, 525-600 V:	wait at least 15 minutes
VLT 8032-8300, 525-600 V:	wait at least 30 minutes

176FA159.12

Safety - Modbus
RTU

■ Overview

■ Introduction

These operating instructions provide comprehensive instructions on the installation and set up of the Modbus RTU for VLT® 2800, VLT® 6000 HVAC and VLT® 8000 AQUA Frequency Converter to communicate over a Modbus network.

For specific information on installation and operation of the frequency converter, refer to the VLT® 2800 Operating Instructions, MG.28.AX.YY / VLT® 6000 HVAC Operating Instructions, MG.61.AX.YY / VLT® 8000 Operating Instructions, MG.80.AX.YY.

■ About This Manual

These operating instructions are intended to be used for both instruction and reference. It only briefly touches on the basics of the Modbus protocol whenever necessary to gain an understanding of the Modbus RTU.

These operating instructions are also intended to serve as a guideline when you specify and optimise your communication system. Even if you are an experienced Modbus programmer, it is suggested that you read these operating instructions in its entirety before you start programming since important information can be found in all sections.

■ Assumptions

These operating instructions assume that you have a controller that supports the interfaces in this document and that all the requirements stipulated in the controller, as well as the frequency converter, are strictly observed, along with all limitations therein.

■ What You Should Already Know

The Modbus RTU is designed to communicate with any controller that supports the interfaces defined in this document. It is assumed that you have full knowledge of the capabilities and limitations of the controller.

■ Modbus RTU Overview

Modbus RTU (Remote Terminal Unit) protocol defines a message structure that controllers will recognise and use, regardless of the type of physical networks over which they communicate. It describes the process a controller uses to request access to another device, how it will respond to requests from the

other devices, and how errors will be detected and reported. It establishes a common format for the layout and contents of message fields.

During communications on a Modbus RTU network, the protocol determines how each controller will know its device address, recognise a message addressed to it, determine the kind of action to be taken, and extract any data or other information contained in the message. If a reply is required, the controller will construct the reply message and send it.

Controllers communicate using a master-slave technique in which only one device (the master) can initiate transactions (called queries). The other devices (slaves) respond by supplying the requested data to the master, or by taking the action requested in the query.

The master can address individual slaves, or can initiate a broadcast message to all slaves. Slaves return a message (called a response) to queries that are addressed to them individually. Responses are not returned to broadcast queries from the master.

The Modbus RTU protocol establishes the format for the master's query by placing into it the device (or broadcast) address, a function code defining the requested action, any data to be sent, and an error-checking field. The slave's response message is also constructed using Modbus protocol. It contains fields confirming the action taken, any data to be returned, and an error-checking field. If an error occurred in receipt of the message, or if the slave is unable to perform the requested action, the slave will construct an error message and send it in response or a time-out will occur.

■ VLT 2800, VLT 6000 and VLT 8000 with Modbus RTU

The frequency converter communicates in Modbus RTU format over an EIA-485 (formerly RS-485) network. Modbus RTU allows access to the frequency converter's Control Word and Bus Reference.

The Control Word allows the Modbus master to control several important functions of the frequency converter:

- Start
- Stop the frequency converter in several ways:
 - Coast stop
 - Quick stop
 - DC Brake stop
 - Normal (ramp) stop
- Reset after a fault trip
- Run at a variety of preset speeds
- Run in reverse
- Change the active setup
- Control the frequency converter's two built-in relays

The Bus Reference is commonly used for speed control.

It is also possible to access the parameters, read their values, and, where possible, write values to them. This permits a range of control possibilities, including controlling the frequency converter's setpoint when its internal PID controller is used.

■ Installation and Setup

Modbus RTU is a transmission protocol developed for process control systems. The Modbus standard does not specify the physical interface for the protocol i.e. a number of different interfaces can be chosen. The Modbus RTU protocol is based on the build-in RS-485 (EIA-485) interface.

RS-485 is a two-wire bus-interface that allows multi-drop network topology i.e. nodes can be connected as a bus, or via drop cables from a common trunk line.

A total number of 32 nodes can be connected to one Modbus RTU network segment, and a total of 247 nodes in a network are supported.

Network segments are divided with repeaters. Please note that each repeater counts for a node in each segment it's installed.

Every node connected to the same network must have a unique nodes address, across all segments.

Every segment must be terminated in both ends, either with the termination switches (switch 2 & 3) of the VLT 6000 / VLT 8000 or with a biased termination resistor network.

For bus-cabling always use cable of screened twisted pair type (STP), and make sure to follow good common installation practice.

Make sure the screen of the Modbus RTU cable must always be connected to ground at all nodes.

It is very important to have a low impedance ground connection of the screen, also at high frequencies. This can be obtained by connecting a large surface of the screen to ground, for example by means of a cable clamp or a conductive cable gland. Particularly in installation where there is long cable lengths, it can be necessary to apply potential equalizing cables to ensure same ground potential throughout the network.

To prevent impedance mismatch, always use cable of same type across the entire network. When connecting a motor to the frequency converter, make sure always to use screened motor cable.

Address range:

1 - 247

Baud Rate:

300 - 9600 bps

Cable:

Screened twisted pair (STP)
Impedance: 120 Ohm

Cable length:

Max. 1200 m (including drop lines)
Max. 500 m station-to-station

■ Network Connection

Connect the frequency converter to the Modbus RTU in accordance with the following procedure (see Figure 1).

1. Connect signal wires to terminal 68 (P+) and terminal 69 (N-) on main control board of the frequency converter.
2. The shield of the cable must be connected to the cable clamps.



NB!:

It is recommended to use shielded, twisted-pair cables to reduce noise between conductors.

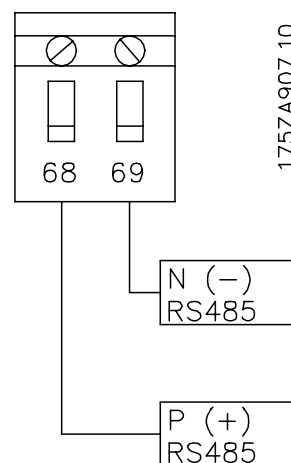

Figure 1 Network Terminal Connection

VLT® 2800, VLT® 6000 HVAC and VLT® 8000 AQUA Modbus RTU

■ Hardware Setup VLT 2800

The VLT 2800 control card does not have build-in termination network for RS 485. To terminate with the

correct impedance in the network the following resistors should be applied at the first and the last station.

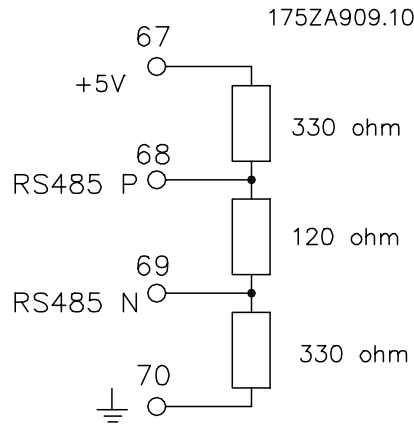

■ Hardware Setup VLT 6000 and VLT 8000

A terminator dip switch on the main control board of the frequency converter is used to terminate the Modbus RTU bus. The switch positions shown in Figure 2 demonstrate the factory setting. Table 1 lists the switch functions and settings required for Modbus RTU operation.

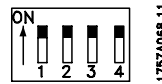

Figure 2 Terminator Switch Factory Setting



NB!: Factory setting for DIP Switch is on.

Table 1 Terminator Switch Functions and Modbus RTU

Switch	Setting
Switches 2 & 3	Used for terminating an RS-485 interface. On first and last devices in a multiple device network, or on the only device in a single device network, switches 2 and 3 must be ON. On all other devices in a multiple device network, 2 and 3 must be OFF.



NB!: Terminator switch positions must be set correctly in accordance with Table 1 for proper Modbus RTU serial communication.

■ EMC Precautions

The following EMC precautions are recommended in order to achieve interference-free operation of the Modbus RTU network.



NB!: Relevant national and local regulations, for example regarding protective earth connection, must be observed.

The Modbus RTU communication cable must be kept away from motor and brake resistor cables to avoid coupling of high frequency noise from one cable to the other. Normally a distance of 200 mm (8 inches) is sufficient, but it is generally recommended to keep the greatest possible distance between the cables, especially where cables run in parallel over long distances. If the Modbus RTU cable has to cross a motor and brake resistor cable they must cross each other at an angle of 90 degrees.

■ VLT 2800 Parameter Settings for Modbus

Communication

Using the Modbus RTU Protocol requires setting of the below listed parameters.



NB!:

Please make sure that par. 512 *Telegram Profile* is set to FC PROFILE.

See the VLT 2800 Operating Instructions *MG.28.AX.YY* for details on selecting and changing parameter values, if necessary.

500 Address (BUS ADDRESS)

Value:

Parameter 500 Protocol = FC protocol [0]	
0 - 247	★ 1
Parameter 500 Protocol = Metasys N2 [1]	
1 - 255	★ 1
Parameter 500 Protocol = MODBUS RTU [3]	
1 - 247	★ 1

Function:

This parameter allows the allocation of an address to each frequency converter in a serial communication network.

Description of choice:

The individual frequency converter must be allocated a unique address.
If the number of units connected (frequency converters + master) is higher than 31, a repeater must be used.
Parameter 500 *Address* cannot be selected via the serial communication, but must be preset via the control unit.

501 Baudrate (BAUDRATE)

Value:

300 Baud (300 BAUD)	[0]
600 Baud (600 BAUD)	[1]
1200 Baud (1200 BAUD)	[2]
2400 Baud (2400 BAUD)	[3]
4800 Baud (4800 BAUD)	[4]
★9600 Baud (9600 BAUD)	[5]

Function:

This parameter is for programming the speed at which data is transmitted via the serial port. Baud rate is defined as the number of bits transmitted per second.

Description of choice:

The frequency converter's transmission speed must be set at a value corresponding to the transmission speed of the master.
Parameter 501 *Baudrate* cannot be selected via the serial port, but must be preset via the operating unit.

561 Protocol (PROTOCOL)

Value:

★FC protocol (FC PROTOCOL)	[1]
Metasys N2 (METASYS N2)	[2]
MODBUS RTU (MODBUS RTU)	[3]

Function:

There is a choice of three different protocols.

Description of choice:

Select the required control word protocol.

570 Modbus parity and message framing (M.BUS PAR./FRAME)

Value:

(EVEN/1 STOPBIT)	[0]
(ODD/1 STOPBIT)	[1]
★(NO PARITY/1 STOPBIT)	[2]
(NO PARITY/2 STOPBIT)	[3]

Function:

This parameter sets up the drive's Modbus RTU interface to communicate properly with the master controller. The parity (EVEN, ODD, or NO PARITY) must be set to match the setting of the master controller.

Description of choice:

Select the parity that matches the setting for the Modbus master controller. Even or odd parity is sometimes used to allow a transmitted word to be checked for errors. Because Modbus RTU uses the more efficient CRC (Cyclic Redundancy Check) method of checking for errors, parity checking is seldom used in Modbus RTU networks.

**571 Modbus communications timeout
(M.BUS COM.TIME.)****Value:**

10 ms - 2000 ms

★ 100 ms

Function:

This parameter determines the maximum amount of time that the drive's Modbus RTU will wait between characters that are sent by the master controller. When this amount of time expires, the drive's Modbus RTU interface will assume that it has received the entire message.

Description of choice:

Generally, the value of 100 ms is sufficient for Modbus RTU networks, although some Modbus RTU networks may operate on a time-out value as short as 35 ms.

If this value is set too short, the drive's Modbus RTU interface may miss a part of the message. Since the CRC check will not be valid, the drive will ignore the message. The resulting retransmissions of messages will slow communications on the network.

If this value is set too long, the drive will wait longer than necessary to determine that the message is completed. This will delay the drive's response to the message and possibly cause the master controller to time out. The resulting retransmissions of messages will slow communications on the network.

■ VLT 6000 Parameter Settings for Modbus Communication

Using the Modbus RTU Protocol requires setting of the below listed parameters.

See the VLT 6000 Operating Instructions *MG.61.AX.YY* for details on selecting and changing parameter values, if necessary.

500 Protocol (PROTOCOL)

Value:	
★FC protocol (FC PROTOCOL)	[0]
Metasys N2 (METASYS N2)	[1]
Landis/Staefa Apogee FLN (LS FLN)	[2]
Modbus RTU (MODBUS RTU)	[3]

Function:

There is a choice of four different protocols.

Description of choice:

Select the required control word protocol.

501 Address (ADDRESS)

Value:	
Parameter 500 Protocol = FC protocol [0]	
0 - 126	★ 1
Parameter 500 Protocol = Metasys N2 [1]	
1 - 255	★ 1
Parameter 500 Protocol = LS FLN [2]	
0 - 98	★ 1
Parameter 500 Protocol = MODBUS RTU [3]	
1 - 247	★ 1

Function:

In this parameter it is possible to allocate an address in a serial communication network to each frequency converter.

Description of choice:

The individual frequency converter must be given a unique address.
 If the number of units connected (frequency converters + master) exceeds 31, an amplifier (repeater) must be used. Parameter 501 Address cannot be chosen via serial communication, but must be set via the LCP control unit.

570 Modbus parity and message framing (M.BUS PAR./FRAME)

Value:	
(EVEN/1 STOPBIT)	[0]
(ODD/1 STOPBIT)	[1]
★(NO PARITY/1 STOPBIT)	[2]
(NO PARITY/2 STOPBIT)	[3]

Function:

This parameter sets up the drive's Modbus RTU interface to communicate properly with the master controller. The parity (EVEN, ODD, or NO PARITY) must be set to match the setting of the master controller.

Description of choice:

Select the parity that matches the setting for the Modbus master controller. Even or odd parity is sometimes used to allow a transmitted word to be checked for errors. Because Modbus RTU uses the more efficient CRC (Cyclic Redundancy Check) method of checking for errors, parity checking is seldom used in Modbus RTU networks.

571 Modbus communications timeout (M.BUS COM.TIME.)

Value:	
10 ms - 2000 ms	★ 100 ms

Function:

This parameter determines the maximum amount of time that the drive's Modbus RTU will wait between characters that are sent by the master controller. When this amount of time expires, the drive's Modbus RTU interface will assume that it has received the entire message.

Description of choice:

Generally, the value of 100 ms is sufficient for Modbus RTU networks, although some Modbus RTU networks may operate on a time-out value as short as 35 ms. If this value is set too short, the drive's Modbus RTU interface may miss a part of the message. Since the CRC check will not be valid, the drive will ignore the message. The resulting retransmissions of messages will slow communications on the network.
 If this value is set too long, the drive will wait longer than necessary to determine that the message is completed. This will delay the drive's response to the message and possibly cause the master controller to time out. The resulting retransmissions of messages will slow communications on the network.

★ = factory setting. () = display text [] = value for use in communication via serial communication port

■ VLT 8000 Parameter Settings for Modbus

Communication

Using the Modbus RTU Protocol requires setting of the below listed parameters.

See the VLT 8000 Operating Instructions MG.80.AX.YY for details on selecting and changing parameter values, if necessary.

500 Protocol (PROTOCOL)

Value:	
★FC protocol (FC PROTOCOL)	[0]
Modbus RTU (MODBUS RTU)	[1]

Function:

There is a choice of two different protocols.

Description of choice:

Select the required control word protocol.

501 Address (ADDRESS)

Value:	
Parameter 500 Protocol = FC protocol [0]	
0 - 126	★ 1
Parameter 500 Protocol = MODBUS RTU [1]	
1 - 247	★ 1

Function:

In this parameter it is possible to allocate an address in a serial communication network to each frequency converter.

Description of choice:

The individual frequency converter must be given a unique address.
If the number of units connected (frequency converters + master) exceeds 31, an amplifier (repeater) must be used. Parameter 501 Address cannot be chosen via serial communication, but must be set via the LCP control unit.

570 Modbus parity and message framing (M.BUS PAR./FRAME)

Value:	
(EVEN/1 STOPBIT)	[0]
(ODD/1 STOPBIT)	[1]
★(NO PARITY/1 STOPBIT)	[2]
(NO PARITY/2 STOPBIT)	[3]

★ = factory setting. () = display text [] = value for use in communication via serial communication port

Function:

This parameter sets up the drive's Modbus RTU interface to communicate properly with the master controller. The parity (EVEN, ODD, or NO PARITY) must be set to match the setting of the master controller.

Description of choice:

Select the parity that matches the setting for the Modbus master controller. Even or odd parity is sometimes used to allow a transmitted word to be checked for errors. Because Modbus RTU uses the more efficient CRC (Cyclic Redundancy Check) method of checking for errors, parity checking is seldom used in Modbus RTU networks.

571 Modbus communications timeout (M.BUS COM.TIME.)

Value:	
10 ms - 2000 ms	★ 100 ms

Function:

This parameter determines the maximum amount of time that the drive's Modbus RTU will wait between characters that are sent by the master controller. When this amount of time expires, the drive's Modbus RTU interface will assume that it has received the entire message.

Description of choice:

Generally, the value of 100 ms is sufficient for Modbus RTU networks, although some Modbus RTU networks may operate on a time-out value as short as 35 ms. If this value is set too short, the drive's Modbus RTU interface may miss a part of the message. Since the CRC check will not be valid, the drive will ignore the message. The resulting retransmissions of messages will slow communications on the network. If this value is set too long, the drive will wait longer than necessary to determine that the message is completed. This will delay the drive's response to the message and possibly cause the master controller to time out. The resulting retransmissions of messages will slow communications on the network.

■ Network Configuration

■ Remote Terminal Unit

The controllers are setup to communicate on the Modbus network using RTU (Remote Terminal Unit) mode, with each 8-bit byte in a message contains two 4-bit hexadecimal characters. The format for each byte is shown below.

Coding System:	8-bit binary, hexadecimal 0-9, A-F Two hexadecimal characters contained in each 8-bit field of the message
Bits Per Byte:	1 start bit 8 data bits, least significant bit sent first 1 bit for even/odd parity; no bit for no parity 1 stop bit if parity is used; 2 bits if no parity
Error Check Field:	Cyclical Redundancy Check (CRC)



■ Modbus RTU Message Framing Structure

A Modbus RTU message is placed by the transmitting device into a frame with a known beginning and ending point. This allows receiving devices to begin at the start of the message, read the address portion, determine which device is addressed (or all devices, if the message is broadcast), and to know when the message is completed. Partial messages are detected and errors set as a result.

The allowable characters transmitted for all fields are hexadecimal 00 to FF. The frequency converter

monitor the network bus continuously, including 'silent' intervals. When the first field (the address field) is received, each frequency converter or device decodes it to determine whether it is the addressed device.

Modbus RTU messages addressed to zero are broadcast messages. No response is permitted on broadcast messages.

A typical message frame is shown below.

Start	Address	Function	Data	CRC Check	End
T1-T2-T3-T4	8 Bits	8 Bits	n x 8 bits	16 Bits	T1-T2-T3-T4

Typical Modbus RTU Message Structure

■ Start/Stop Field

Messages start with a silent interval of at least 3.5 character times. This is implemented as a multiple of character times at the selected network baud rate (shown as Start T1-T2-T3-T4). The first field then transmitted is the device address. Following the last transmitted character, a similar interval of at least 3.5 character times marks the end of the message. A new message can begin after this interval.

The entire message frame must be transmitted as a continuous stream. If a silent interval of more than 1.5 character times occurs before completion of the frame, the receiving device flushes the incomplete

message and assumes that the next byte will be the address field of a new message.

Similarly, if a new message begins earlier than 3.5 character times following a previous message, the receiving device will consider it a continuation of the previous message. This will cause a time-out (no response from the slave), since the value in the final CRC field is not valid for the combined messages.

■ Address Field

The address field of a message frame contains 8 bits. Valid slave device addresses are in the range of 0 – 247 decimal. The individual slave devices are assigned addresses in the range of 1 – 247. (0 is reserved for broadcast mode, which all slaves recognize.) A master addresses a slave by placing the slave address in the address field of the message. When the slave sends its response, it places its own address in this address field to let the master know which slave is responding.

■ Function Field

The function field of a message frame contains 8 bits. Valid codes are in the range of 1-FF. (See section *Modbus RTU Function Codes*.) When a message is sent from a master to a slave device, the function code field tells the slave what kind of action to perform.

When the slave responds to the master, it uses the function code field to indicate either a normal (error-free) response, or that some kind of error occurred (called an exception response). For a normal response, the slave simply echoes the original function code. For an exception response, the slave returns a code that is equivalent to the original function code with its most-significant bit set to a logic 1. In addition, the slave places a unique code into the data field of the response message. This tells the master what kind of error occurred, or the reason for the exception. See the chapter *Exception Codes* in these operating instructions for definitions.

■ Data Field

The data field is constructed using sets of two hexadecimal digits, in the range of 00 to FF hexadecimal. These are made from one RTU character. The data field of messages sent from a master to slave device contains additional information which the slave must use to take the action defined by the function code. This can include items like coil or register addresses, the quantity of items to be handled, and the count of actual data bytes in the field.

■ CRC Check Field

Messages include an error-checking field that is based on a cyclical redundancy check (CRC) method. The CRC field checks the contents of the entire message. It is applied regardless of any parity check method used for the individual characters of the message. The CRC value is calculated by the transmitting device, which

appends the CRC as the last field in the message. The receiving device recalculates a CRC during receipt of the message and compares the calculated value to the actual value received in the CRC field. If the two values are not equal, a bus time-out results.

The error checking field contains a 16-bit binary value implemented as two 8-bit bytes. When this is done, the low-order byte of the field is appended first, followed by the high-order byte. The CRC high-order byte is the last byte sent in the message.

■ Coil/Register Addressing

All data addresses in Modbus messages are referenced to zero. The first occurrence of a data item is addressed as item number zero. For example:

The coil known as ‘coil 1’ in a programmable controller is addressed as coil 0000 in the data address field of a Modbus message. Coil 127 decimal is addressed as coil 007E_{HEX} (126 decimal).

Holding register 40001 is addressed as register 0000 in the data address field of the message. The function code field already specifies a ‘holding register’ operation. Therefore, the ‘4XXXX’ reference is implicit. Holding register 40108 is addressed as register 006B_{HEX} (107 decimal).

■ Parameter Handling

■ Parameter Handling

PNU (Parameter Number) is translated from the register address contained in the Modbus read/write message. The parameter number is translated to Modbus as (10 x parameter number)_{DECIMAL}.

■ Storage of Data

Coil 65 decimal determines whether data written to the frequency converter are stored in EEPROM and RAM (coil 65 = 1) or just RAM (coil 65 = 0).

■ IND

Array index is set in Holding Register 9 and used when accessing array parameters in the frequency converter such as parameter 606-617 (Logs).

■ Text Blocks

Parameters stored as text strings are accessed in the same way as the other parameters. The maximum text block size is 20 characters. If a read request for a parameter is for more characters than the parameter stores, the response is space filled. If the read request for a parameter is for less characters than the parameter stores, the response is truncated.

■ PCD₁ / PCD₂

PCD contains the process word block. The parameter value block consists of 2 words (4 bytes). The process word block is divided into two blocks of 16 bits and is stored in Modbus as status coils. The mapping of the PCD is shown in the table below.

■ Conversion Factor

The different attributes for each parameter can be seen in the section on factory settings. Since a parameter value can only be transferred as a whole number, a conversion factor must be used to transfer decimals.

Parameter 201: *Minimum Frequency*, conversion factor 0.1. If parameter 201 is to be set to 10 Hz, a value of 100 must be transferred, since a conversion factor of 0.1 means that the transferred value will be multiplied by 0.1. A value of 100 will, therefore, be understood as 10.0.

Index	Factor
74	3.6
2	100.0
1	10.0
0	1.0
-1	0.1
-2	0.01
-3	0.001
-4	0.0001

■ Parameter Values

Standard Data Types

Standard data types are int16, int32, uint8, uint16 and uint32. They are stored as 4x registers (40001 – 4FFFF). The parameters are read using function 03_{HEX} "Read Holding Registers." Parameters are written using function 6_{HEX} "Preset Single Register" for 1 register (16 bits), and function 10_{HEX} "Preset Multiple Registers" for 2 registers (32 bits). Valid sizes to read are 1 register (16 bits) and through 10 registers (20 characters).

Nonstandard Data Types

Nonstandard data types are text strings and are stored as 4x registers (40001 – 4FFFF). The parameters are read using function 03_{HEX} "Read Holding Registers" and written using function 10_{HEX} "Preset Multiple Registers." Valid sizes to read are 1 register (2 characters) through 10 registers (20 characters).

■ Register Maps VLT 2800

Note: the Holding Register number shown in the following table must be transmitted as ("shown value-1") in MODBUS telegrams (e.g. Holding Register 4:00001 is transmitted as address 0 in MODBUS telegrams).

Holding Register (decimal)	Description
00001-00008	Reserved
00009	Array index (1-255)
00010	Parameter 001, <i>Language</i>
↓	↓
00250	Parameter 025, <i>Quick Menu Setup</i>
00260-00999	Reserved
01000	Parameter 100, <i>Configuration</i>
↓	↓
01460	Parameter 146, <i>Reset Voltage Vector</i>
01470-1999	Reserved
02000	Parameter 200, <i>Output Frequency Range</i>
↓	↓
02310	Parameter 231, <i>Frequency Bypass 2</i>
02320-02999	Reserved
03020	Parameter 302, <i>Digital Input, Terminal 18</i>
↓	↓
03490	Parameter 349, <i>Speed Compensation Delay</i>
03500-03999	Reserved
04000	Parameter 400, <i>Reset Function</i>
↓	↓
04560	Parameter 456, <i>Brake Voltage Reduce</i>
04570-04999	Reserved
05000	Parameter 500, <i>Protocol</i>
↓	↓
05440	Parameter 544, <i>Pulse Count</i>
05450-05999	Reserved
06000	Parameter 600, <i>Operating Data: Operating Hours</i>
↓	↓
06420	Parameter 642, <i>Power Card Identification</i>
06430-65536	Reserved

■ Register Maps VLT 6000

Note: the Holding Register number shown in the following table must be transmitted as ("shown value-1") in MODBUS telegrams (e.g. Holding Register 4:00001 is transmitted as address 0 in MODBUS telegrams).

Holding Register (decimal)	Description
00001-00008	Reserved
00009	Array index (1-255)
00010	Parameter 001, <i>Language</i>
↓	↓
00170	Parameter 017, <i>Operating State at Power-up</i>
00180-00999	Reserved
01000	Parameter 100, <i>Configuration</i>
↓	↓
01180	Parameter 118, <i>Motor Power Factor</i>
01190-1999	Reserved
02000	Parameter 200, <i>Output Frequency Range</i>
↓	↓
02280	Parameter 228, <i>Warning: High Feedback</i>
02290-02999	Reserved
03000	Parameter 300, <i>Terminal 16 Digital Input</i>
↓	↓
03650	Parameter 365, <i>Terminal 45, Bus Control</i>
03660-03999	Reserved
04000	Parameter 400, <i>Reset Function</i>
↓	↓
04830	Parameter 483, <i>Dynamic DC Link Compensation</i>
04840-04999	Reserved
05000	Parameter 500, <i>Protocol</i>
↓	↓
05710	Parameter 571, <i>Modbus Communications Timeout</i>
05720-05999	Reserved
06000	Parameter 600, <i>Operating Data: Operating Hours</i>
↓	↓
06310	Parameter 631, <i>Nameplate: Communication Option Ordering No.</i>
06320-06999	Reserved
07000	Parameter 700, <i>Relay 6, Output Function</i>
↓	↓
07110	Parameter 711, <i>Relay 9, Off Delay</i>
07120-65536	Reserved

■ Register Maps VLT 8000

Note: the Holding Register number shown in the following table must be transmitted as ("shown value-1") in MODBUS telegrams (e.g. Holding Register 4:00001 is transmitted as address 0 in MODBUS telegrams).

Holding Register (decimal)	Description
00001-00008	Reserved
00009	Array index (1-255)
00010	Parameter 001, <i>Language</i>
↓	↓
00170	Parameter 017, <i>Operating State at Power-up</i>
00180-00999	Reserved
01000	Parameter 100, <i>Configuration</i>
↓	↓
01240	Parameter 124, <i>Stator Reactance</i>
01250-1999	Reserved
02000	Parameter 200, <i>Output Frequency Range</i>
↓	↓
02310	Parameter 231, <i>Filled Set Point</i>
02320-02999	Reserved
03000	Parameter 300, <i>Terminal 16 Digital Input</i>
↓	↓
03650	Parameter 365, <i>Terminal 45, Bus Control</i>
03660-03999	Reserved
04000	Parameter 400, <i>Reset Function</i>
↓	↓
04830	Parameter 483, <i>Dynamic DC Link Compensation</i>
04840-04999	Reserved
05000	Parameter 500, <i>Protocol</i>
↓	↓
05710	Parameter 571, <i>Modbus Communications Timeout</i>
05720-05999	Reserved
06000	Parameter 600, <i>Operating Data: Operating Hours</i>
↓	↓
06310	Parameter 631, <i>Nameplate: Communication Option Ordering No.</i>
06320-06999	Reserved
07000	Parameter 700, <i>Relay 6, Output Function</i>
↓	↓
07110	Parameter 711, <i>Relay 9, Off Delay</i>
07120-65536	Reserved

■ Process Data

Process Data is illustrated as coils in Modbus RTU.

■ Status Coil Maps (128 coils total)

Note: The coil number shown in the following table must be transmitted as ("shown value-1") in MODBUS telegrams (e.g. Coil number 0:00001 is transmitted as address 0000 in the MODBUS telegram).

Coil Number	Description
1-16	PCD ₁ Control Word (master → slave)
17-32	PCD ₂ Reference Value (master → slave)
33-48	PCD ₁ Status Word (slave → master)
49-64	PCD ₂ Given output frequency (slave → master)
65	Write parameters to eeprom (1 = true / 0 = false)
66-128	Reserved

■ Control Word Bit Descriptions for VLT 2800

The control word is used to send commands from a master (e.g. a PC) to a slave (frequency converter).

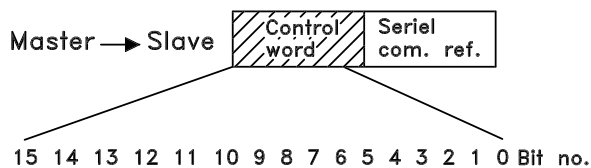

Bit	Bit = 0	Bit = 1
00		Preset ref. lsb
01		Preset ref. msb
02	DC braking	
03	Coasting stop	
04	Quick stop	
05	Freeze outp. freq.	
06	Ramp stop	Start
07		Reset
08		Jog
09	Ramp 1	Ramp 2
10	Data not valid	Data valid
11	No function	Relay 01 activated
12	No function	Digital output Terminal 46 activated
13	Select Setup, lsb	
14	Select Setup, msb	
15		Reversing

Bit 00/01:

Bit 00/01 is used to select between the two pre-programmed references (parameters 215-218 *Preset reference*) according to the following table:

Preset ref.	Parameter	Bit 01	Bit 00
1	215	0	0
2	216	0	1
3	217	1	0
4	218	1	1



NB!:

In parameter 508 *Selection of preset reference* a selection is made to define how Bit 00/01 gates with the corresponding function on the digital inputs.

Bit 02, DC brake:

Bit 02 = '0' causes DC braking and stop. Brake voltage and duration are preset in parameters 132 *DC brake voltage* and parameter 126 *DC braking time*. Note: In parameter 504 *DC brake* a selection is made to define how Bit 02 gates with the corresponding function on a digital input.

Bit 03, Coasting stop:

Bit 03 = '0' causes the frequency converter to immediately "let go" of the motor (the output transistors are "shut off"), so that it coasts to a standstill. Bit 03 = '1' causes the frequency converter to be able start the motor if the other starting conditions have been fulfilled. Note: In parameter 502 *Coasting stop* a selection is made to define how Bit 03 gates with the corresponding function on a digital input.

Bit 04, Quick stop:

Bit 04 = '0' causes a stop, in which the motor's speed is ramped down to stop via parameter 212 *Quick stop ramp-down time*.

Bit 05, Freeze output frequency:

Bit 05 = '0' causes the present output frequency (in Hz) to freeze. The frozen output frequency can now only be changed by means of the digital inputs programmed to *Speed up* and *Speed down*.



NB!:

If *Freeze output* is active, the frequency converter cannot be stopped via Bit 06 *Start* or via a digital input. The frequency converter can only be stopped by the following:

- Bit 03 *Coasting stop*
- Bit 02 *DC braking*
- Digital input programmed to *DC braking*, *Coasting stop* or *Reset and coasting stop*.

Bit 06, Ramp stop/start:

Bit 06 = '0' causes a stop, in which the motor's speed is ramped down to stop via the selected *ramp down* parameter.

Bit 06 = '1' causes the frequency converter to be able to start the motor, if the other starting conditions have been fulfilled. Note: In parameter 505 *Start* a selection is made to define how Bit 06 Ramp stop/start gates with the corresponding function on a digital input.

Bit 07, Reset:

Bit 07 = '0' does not cause a reset.

Bit 07 = '1' causes the reset of a trip. Reset is activated on the signal's leading edge, i.e. when changing from logic '0' to logic '1'.

Bit 08, Jog:

Bit 08 = '1' causes the output frequency to be determined by parameter 213 *Jog frequency*.

Bit 09, Selection of ramp 1/2:

Bit 09 = "0" means that ramp 1 is active (parameters 207/208). Bit 09 = "1" means that ramp 2 (parameters 209/210) is active.

Bit 10, Data not valid/Data valid:

Is used to tell the frequency converter whether the control word is to be used or ignored. Bit 10 = '0' causes the control word to be ignored, Bit 10 = '1' causes the control word to be used. This function is relevant, because the control word is always contained in the telegram, regardless of which type of telegram is used, i.e. it is possible to turn off the control word if you do not wish to use it in connection with updating or reading parameters.

Bit 11, Relay 01:

Bit 11 = "0" Relay not activated.

Bit 11 = "1" Relay 01 activated, provided *Control word bit* has been chosen in parameter 323.

Bit 12, Digital output, terminal 46:

Bit 12 = "0" Digital output has not been activated.

Bit 12 = "1" Digital output has been activated, provided *Control word bit* has been chosen in parameter 341.

Bit 13/14, Selection of Setup:

Bits 13 and 14 are used to choose from the four menu Setups according to the following table:

Setup	Bit 14	Bit 13
1	0	0
2	0	1
3	1	0
4	1	1

The function is only possible when *Multi-Setups* is selected in parameter 004 *Active Setup*.

Note: In parameter 507 *Selection of Setup* a selection is made to define how Bit 13/14 gates with the corresponding function on the digital inputs.

Bit 15 Reversing:

Bit 15 = '0' causes no reversing.

Bit 15 = '1' causes reversing.

Note: In the factory setting reversing is set to *digital* in parameter 506 *Reversing*. Bit 15 only causes reversing when either *Ser. communication*, *Logic or* or *Logic and* is selected.

■ Status Word Bit Description for VLT 2800

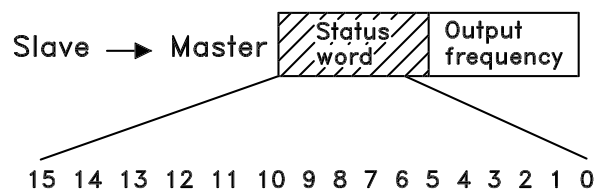

The status word is used to inform the master (e.g. a PC) of the slave's (frequency converter) mode. Slave⇒Master.

Bit	Bit = 0	Bit = 1
00		Control ready
01		Drive ready
02	Coasting stop	
03	No trip	Trip
04	Not used	
05	Not used	
06		Trip lock
07	No warning	Warning
08	Speed ≠ ref.	Speed = ref.
09	Local control	Ser. communi.
10	Outside frequency range	Frequency limit OK
11		Motor running
12		
13		Voltage warn.
14		Current limit
15		Thermal warn.

Bit 00, Control ready:

Bit 00 = '1'. The frequency converter is ready for operation.

Bit 00 = '0'. The frequency converter is not ready for operation.

Bit 01, Drive ready:

Bit 01 = '1'. The frequency converter is ready for operation, but there is an active coasting command via the digital inputs or via serial communication.

Bit 02, Coasting stop:

Bit 02 = '0'. The frequency converter has released the motor.

Bit 02 = '1'. The frequency converter can start the motor when a start command is given.

Bit 03, No trip/trip:

Bit 03 = '0' means that the frequency converter is not in fault mode.

Bit 03 = '1' means that the frequency converter is tripped, and that it needs a reset signal for operation to be re-established.

Bit 04, Not used:

Bit 04 is not used in the status word.

Bit 05, Not used:

Bit 05 is not used in the status word.

Bit 06, Trip lock:

Bit 06 = '0' means that the frequency converter is not trip locked.

Bit 06 = '1' means that the frequency converter is trip locked and it cannot be reset before the mains supply has been removed. The trip can be reset either with 24 V external control back up or after the power is connected again.

Bit 07, No warning/warning:

Bit 07 = '0' means that there are no warnings.

Bit 07 = '1' means that a warning has occurred.

Bit 08, Speed≠ ref/speed = ref.:

Bit 08 = '0' means that the motor is running, but that the present speed is different from the preset speed reference. It might, for example, be the case while the speed is being ramped up/down during start/stop.

Bit 08 = '1' means that the motor's present speed is the same as the preset speed reference.

Bit 09, Local operation/serial communication control:

Bit 09 = '0' means that [STOP/RESET] is activated on the control unit, or that *Local control* in parameter 002 *Local/remote operation* is selected. It is not possible to control the frequency converter via serial communication.

Bit 09 = '1' means that it is possible to control the frequency converter via serial communication.

Bit 10, Outside frequency range:

Bit 10 = '0', if the output frequency has reached the value in parameter 201 *Output frequency low limit* or parameter 202 *Output frequency high limit*. Bit 10 = "1" means that the output frequency is within the defined limits.

Bit 11, Running/not running:

Bit 11 = '0' means that the motor is not running.

Bit 11 = '1' means that the frequency converter has a start signal or that the output frequency is greater than 0 Hz.

Bit 13, Voltage warning high/low:

Bit 13 = '0' means that there are no voltage warnings.

Bit 13 = '1' means that the DC voltage in the frequency converter's intermediate circuit is too low or too high.

Bit 14, Current limit:

Bit 14 = '0' means that the output current is less than the value in parameter 221 *Current Limit I_{LIM}*.

Bit 14 = '1' means that the output current is greater than the value in parameter 221 *Current Limit I_{LIM}* and that the frequency converter will trip after a set period of time.

Bit 15, Thermal warning:

Bit 15 = '0' means that there is no thermal warning.

Bit 15 = '1' means that the temperature limit has been exceeded in either the motor, frequency converter or from a thermistor that is connected to a digital input.

Serial communication reference

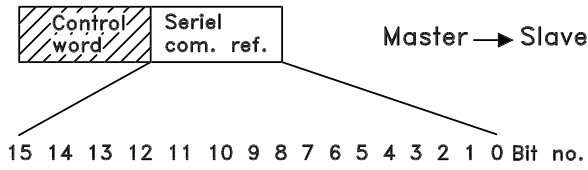

The serial communication reference is transferred to the frequency converter as a 16-bit word. The value is transferred in whole numbers 0 - ±32767 (±200%). 16384 (4000 Hex) corresponds to 100%.

The serial communication reference has the following format: 0-16384 (4000 Hex) ≅ 0-100% (Par. 204 *Minimum ref.* - Par. 205 *Maximum ref.*).

It is possible to change the direction of rotation via the serial reference. This is done by converting the binary reference value to 2' complement. See example.

Example - Control word and serial communication ref.:

The frequency converter is to receive a start command and the reference is to be set to 50% (2000 Hex) of the reference range.
Control word = 047F Hex ⇒ Start command.
Reference = 2000 Hex ⇒ 50% reference.

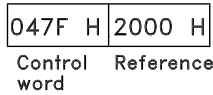

The frequency converter is to receive a start command and the reference is to be set to -50% (-2000 Hex) of the reference range.

The reference value is first converted to 1' complement, and then 1 is added binarily to obtain 2' complement:

2000 Hex	0010 0000 0000 0000 0000
1' complement	1101 1111 1111 1111 1111
	+ 1
2' complement	1110 0000 0000 0000 0000

Control word = 047F Hex ⇒ Start command.
Reference = E000 Hex ⇒ -50% reference.

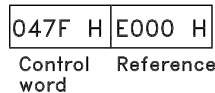

Present output frequency

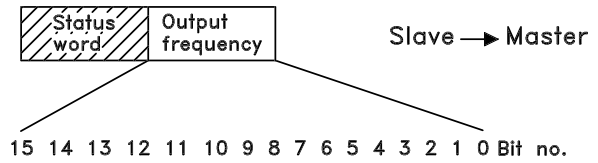

The value of the frequency converter's present output frequency is transferred as a 16-bit word. The value is transferred as whole numbers 0 - ±32767 (±200%). 16384 (4000 Hex) corresponds to 100%.

Output frequency has the following format: 0-16384 (4000 Hex) ≅ 0-100% (Par. 201 *Output frequency low limit* - Par. 202 *Output frequency high limit*).

Example - Status word and current output frequency:

The master receives a status message from the frequency converter that the current output frequency is 50% of the output frequency range.
Par. 201 *Output frequency low limit* = 0 Hz
Par. 202 *Output frequency high limit* = 50 Hz

Status word = 0F03 Hex.

Output frequency = 2000 Hex ⇒ 50% of the frequency range, corresponding to 25 Hz.

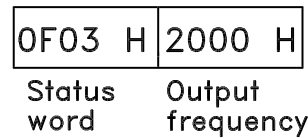

Control Word Bit Descriptions VLT 6000 / VLT 8000

The control word is used for transmitting commands from a master (e.g. a PC) to a slave.

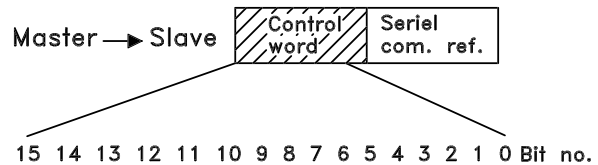

VLT® 2800, VLT® 6000 HVAC and VLT® 8000 AQUA Modbus RTU

Bit	Bit = 0	Bit = 1
00		Preset ref. lsb
01		Preset ref. msb
02	DC braking	
03	Coasting stop	
04	Quick stop	
05	Freeze output frequency	
06	Ramp stop	Start
07		Reset
08		Jog
09	No function	No function
10	Data not valid	Data valid
11		Activate relay 1
12		Activate relay 2
13		Choice of setup lsb
14		Choice of setup msb
15		Reversing

Bit 00/01:

Bits 00 and 01 are used for choosing between the four pre-programmed references (parameters 211 - 214 *Preset reference*) in accordance with the following table:

Preset ref.	Parameter	Bit 01	Bit 00
1	211	0	0
2	212	0	1
3	213	1	0
4	214	1	1



NB!:

Parameter 508 *Choice of preset reference* is used to choose how bits 00/01 are to be gated with the corresponding functions of the digital inputs.

Bit 02, DC BRAKE:

Bit 02 = 0 leads to DC braking and stop. Set braking current and duration in parameter 114 *DC braking current* and in parameter 115 *DC braking time*. Note: Parameter 504 *DC brake* is used for selecting how bit 02 is to be gated with the corresponding function of terminal 27.

Bit 03, Coasting stop:

Bit 03 = "0" means that the frequency converter immediately "lets go" of the motor (the output transistors are "turned off"), which means that the motor runs freely until it stops.
 Bit 03 = "1" means that the frequency converter is able to start the motor, provided the other conditions for starting are fulfilled. Note: In parameter 503 *Coasting stop* the choice is made of how bit 03 is to be gated with the corresponding function of terminal 27.

Bit 04, Quick stop:

Bit 04 = "0" leads to a stop in which the motor speed is ramped down to stop via parameter 207 *Ramp-down time*.

Bit 05, Freeze output frequency:

Bit 05 = "0" means that the given output frequency (in Hz) is frozen. The frozen output frequency can now only be changed via the digital inputs programmed for *Speed up* and *Speed down*.



NB!:

If *Freeze output* is active, the frequency converter cannot be stopped via Bit 06 *Start* or via terminal 18. The frequency converter can only be stopped in the following ways:

- Bit 03 *Coasting stop*
- Terminal 27
- Bit 02 *DC braking*
- Terminal 19 programmed for *DC braking*

Bit 06, Ramp stop/start:

wBit 04 = "0" leads to a stop in which the motor speed is ramped down to stop via parameter 207 *Ramp-down time*.

Bit 06 = "1" means that the frequency converter is able to start the motor, provided the other conditions for starting are fulfilled. Note: In parameter 505 *Start a choice* is made of the way bit 06 *Ramp stop/start* is to be gated with the corresponding function of terminal 18.

Bit 07, Reset:

Bit 07 = "0" leads to no reset.

Bit 07 = "1" means that a trip is reset.

Reset is activated on the leading edge of the signal, i.e. at the change from logic '0' to logic '1'.

Bit 08, Jog:

Bit 08 = "1" means that the output frequency is determined by parameter 209 *Jog frequency*.

Bit 09, No function:

Bit 09 has no function.

Bit 10, Data not valid/Data valid:

Used for telling the frequency converter whether the control is to be used or ignored. Bit 10 = "0" means that the control word is ignored. Bit 10 = "1" means that the control word is used. This function is relevant because the control word is always contained in the telegram, regardless of the type of telegram used, i.e. it is possible to disconnect the control word if it is not to be used in connection with updating or reading of parameters.

Bit 11, Relay 1:

Bit 11 = "0": Relay 1 is not activated.

Bit 11 = "1": Relay 1 is activated, provided *Control word bits 11/12* has been selected in parameter 323 *Relay outputs*.

Bit 12, Relay 2:

Bit 12 = "0": Relay 2 is not activated.

VLT® 2800, VLT® 6000 HVAC and VLT® 8000 AQUA Modbus RTU

Bit 12 = "1": Relay 2 is activated, provided *Control word bits 11/12* has been selected in parameter 326 *Relay outputs*.



NB!:

If the time-out period set in parameter 556 *Bus time interval function* is exceeded, relays 1 and 2 will lose their voltage if they have been activated via serial communication.

Bits 13/14, Choice of Setup:

Bits 13 and 14 are used to choose among the four menu Setups in accordance with the following table:

Setup	Bit 14	Bit 13
1	0	0
2	0	1
3	1	0
4	1	1

This function is only possible if *Multi-setups* has been selected in parameter 004.

Note: In parameter 507 *Choice of Setup* a choice is made of the way bits 13/14 are to be gated with the corresponding function of the digital inputs.

Bit 15, No function/reversing:

Bit 15 = "0" leads to no reversing.
Bit 15 = "1" leads to reversing.

Please note that, in the factory setting, reversing has been selected as digital in parameter 506 *Reversing*, which means that bit 15 only leads to reversing, if *bus, logic or orlogic* and has been selected (however, *logic* and only together with terminal 19).

■ Status Word Bit Descriptions VLT 6000 / VLT 8000

The status word is used to inform the master (e.g. a PC) of the condition of the slave (VLT 6000 HVAC / VLT 8000 AQUA).

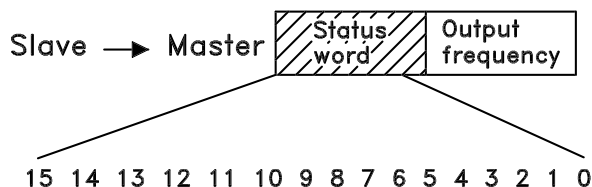

Bit	Bit = 0	Bit = 1
00	Trip	Control ready
01		Drive ready
02		Stand by
03	No trip	Trip
04	Not in use	
05	Not in use	
06	Not in use	
07	No warning	Warning
08	Speed ≠ ref.	Speed = ref.
09	Local operation	Serial com. control
10	Out of frequency range	
11		Running
12	No function	No function
13		Voltage warning high/low
14		Current limit
15		Thermal warning

Parameter Handling

Bit 00, Control ready:

Bit 00 = "1". The frequency converter is ready for operation.
Bit 00 = "0". The frequency converter has tripped.

Bit 01, Drive ready:

Bit 01 = "1". The frequency converter is ready for operation, but terminal 27 is a logic '0' and/or a *coasting command* has been received via serial communication.

Bit 02, Stand by:

Bit 02 = "1". The frequency converter is able to start the motor when a start command is given.

Bit 03, No trip/trip:

Bit 03 = "0" means that the VLT 6000 HVAC is not in an error state. Bit 03 = "1" means that the VLT 6000 HVAC has tripped and needs a reset signal in order for operation to be resumed.

Bit 04, Not in use:

Bit 04 is not used in the status word.

Bit 05, Not in use:

Bit 05 is not used in the status word.

Bit 06, Trip lock:

Bit 06: "1" means that there is a trip lock.

Bit 07, No warning/warning:

Bit 07 = "0" means there is no warning.
Bit 07 = "1" means a warning has occurred.



NB!:

All warnings are described in the Operating Instructions.

Bit 08, Speed ≠ ref./speed = ref.:

Bit 08 = "0" means that the motor is running, but that the present speed is different from the preset

■ Present output frequency

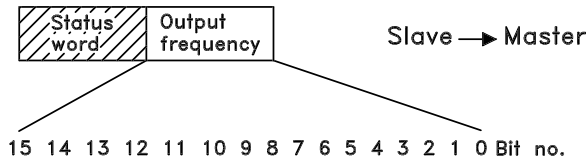

The value of the present output frequency of the frequency converter at any given time is transmitted as a 16-bit word. The value is transmitted in the form of whole numbers 0 - ±32767 (±200 %). 16384 (4000 Hex) corresponds to 100 %.

The output frequency has the following format:

0-16384 (4000 Hex) \cong 0-100 % (Par. 201 *Output frequency low limit* - Par. 202 *Output frequency high limit*).

Example - Status word and present output frequency:
and present output frequency: The master receives a status message from the frequency converter saying that the present output frequency is 50 % of the output frequency range.

Par. 201 *Output frequency low limit* = 0 Hz
Par. 202 *Output frequency high limit* = 50 Hz

Status word = 0F03 Hex. Status message
Output frequency = 2000 Hex. 50 % of the frequency range, corresponding to 25 Hz.

0F03 H	2000 H
Status word	Output frequency

■ **Supported Modbus RTU Function Codes**

This section describes the following functions supported by the Modbus RTU.

Read Coil Status (01_{HEX})
 Force Single Coil (05_{HEX})
 Force Multiple Coils (0F_{HEX})

Read Holding Registers (03_{HEX})
 Preset Single Register (06_{HEX})
 Preset Multiple Registers (10_{HEX})

■ **Read Coil Status (01_{HEX})**

Description

Reads the ON/OFF status of discrete outputs (0X references, coils) in the slave. Broadcast is never supported for reads.

Query

The query message specifies the starting coil and quantity of coils to be read. Coils are addressed starting at zero. Coils 1-16 are addressed as 0-15.

Example of a request to read coils 33-48 (Status Word) from slave device 01.

Field Name	Example (HEX)
Slave Address	01
Function	01
Starting Address HI	00
Starting Address LO	20
No. of Points HI	00
No. of Points LO	10
Error Check (CRC)	-

Response

The coil status in the response message is packed as one coil per bit of the data field. Status is indicated as: 1 = ON; 0 = OFF. The LSB of the first data byte contains the coil addressed in the query. The other coils follow toward the high order end of this byte, and from 'low order to high order' in subsequent bytes. If the returned coil quantity is not a multiple of eight, the remaining bits in the final data byte will be padded with zeros (toward the high order end of the byte). The Byte Count field specifies the quantity of complete bytes of data.

Field Name	Example (HEX)
Slave Address	01
Function	01
Byte Count	02
Data (Coils 40-33)	55
Data (Coils 48-41)	AA
Error Check (CRC)	-

■ **Force Single Coil (05_{HEX})**

Description

Forces a single coil (0X reference) to either ON or OFF. When broadcast, the function forces the same coil references in all attached slaves.

Query

The query message specifies the coil reference to be forced. Coils are addressed starting at zero. Coil 1 is addressed as 0. Force Data = 00_{HEX} (OFF) or FF_{HEX} (ON).

See example 1 *Start Motor, Run Speed 40%*.

Field Name	Example (HEX)
Slave Address	01
Function	05
Coil Address HI	00
Coil Address LO	00
Force Data HI	FF
Force Data LO	00
Error Check (CRC)	-

Response

The normal response is an echo of the query, returned after the coil state has been forced.

Field Name	Example (HEX)
Slave Address	01
Function	05
Force Data HI	FF
Force Data LO	00
Quantity of Coils HI	00
Quantity of Coils LO	0A
Error Check (CRC)	-

■ **Force Multiple Coils (0F_{HEX})**

Description

Forces each coil (0X reference) in a sequence of coils to either ON or OFF. When broadcast, the function forces the same coil references in all attached slaves.

Query

The query message specifies the coil references to be forced. Coils are addressed starting at zero. Coil 1 is addressed as 0.

See example 1 *Start Motor, Run Speed 40 %*.

Field Name	Example (HEX)
Slave Address	01
Function	0F
Coil Address HI	00
Coil Address LO	00
Quantity of Coils HI	00
Quantity of Coils LO	0A
Byt Count	02
Force Data HI (Coils 8-1)	FF
Force Data LO (Coils 10-9)	03
Error Check (CRC)	-

Response

The normal response returns the slave address, function code, starting address, and quantity of coils forced.

Field Name	Example (HEX)
Slave Address	01
Function	0F
Coil Address HI	00
Coil Address LO	00
Quantity of Coils HI	00
Quantity of Coils LO	0A
Error Check (CRC)	-

Field Name	Example (HEX)
Slave Address	01
Function	03
Starting Address HI	00
Starting Address LO	00
No. of Points HI	00
No. of Points LO	03
Error Check (CRC)	-

Response

The register data in the response message are packed as two bytes per register, with the binary contents right justified within each byte. For each register, the first byte contains the high order bits and second contains the low order bits.

Field Name	Example (HEX)
Slave Address	01
Function	03
Byte Count	06
Data HI (Register 40001)	55
Data LO (Register 40001)	AA
Data HI (Register 40002)	55
Data LO (Register 40002)	AA
Data HI (Register 40003)	55
Data LO (Register 40003)	AA
Error Check (CRC)	-

Supported Modbus RTU Function Codes

■ Read Holding Registers (03_{HEX})

Description

Reads the binary contents of holding registers (4x references) in the slave. Broadcast is never supported for reads.

Query

The query message specifies the starting register and quantity of registers to be read. Registers are addressed starting at zero. Registers 1-4 are addressed as 0-3.

See example 4 *Write Parameter 104, Motor Frequency*.

■ Preset Single Register (06_{HEX})

Description

Presets a value into a single holding register (4x reference). When broadcast, the function presets the same register reference in all attached slaves.

Query

The query message specifies the register reference to be preset. Registers are addressed starting at zero. Register 1 is addressed as 0.

See example 4 *Write Parameter 104, Motor Frequency*.

Field Name	Example (HEX)
Slave Address	01
Function	06
Register Address HI	00
Register Address LO	01
Preset Data HI	00
Preset Data LO	03
Error Check (CRC)	-

Field Name	Example (HEX)
Slave Address	01
Function	10
Starting Address HI	04
Starting Address LO	19
No. of Registers HI	00
No of Registers LO	02
Error Check (CRC)	-

Response

The normal response is an echo of the query, returned after the register contents have been passed.

Field Name	Example (HEX)
Slave Address	01
Function	06
Register Address HI	00
Register Address LO	01
Preset Data HI	00
Preset Data LO	03
Error Check (CRC)	-

■ Preset Multiple Registers (10_{HEX})

Description

Presets values into a sequence of holding registers (4x references). When broadcast, the function presets the same register references in all attached slaves.

Query

The query message specifies the register references to be preset. Registers are addressed starting at zero. Register 1 is addressed as 0.

Example of a request to preset two registers (set parameter 105 = 738 (7,38 A))

Field Name	Example (HEX)
Slave Address	01
Function	10
Starting Address HI	04
Starting Address LO	19
No. of Registers HI	00
No of Registers LO	02
Byte Count	04
Write Data HI (Register 4:1049)	00
Write Data LO (Register 4:1049)	00
Write Data HI (Register 4:1050)	02
Write Data LO (Register 4:1050)	E2
Error Check (CRC)	-

Response

The normal response returns the slave address, function code, starting address, and quantity of registers preset.

■ Exception Codes

■ Exception Code Tables

When the frequency converter responds to the master via the Modbus serial network, it uses the function code field to indicate either a normal (error-free) response or an error (called an exception response). In an error-free response, the frequency converter simply echoes the original function code. For an exception response, the

frequency converter will return a code that is equivalent to the original function code with its most-significant bit set to a logic 1. In addition, the frequency converter places a unique code into the data field of the response message. This tells the master what kind of error occurred, or the reason for the exception. The tables below identify the codes and describe their meaning.

Errors	
Modbus Code (decimal)	Meaning
00	The parameter number does not exist
01	There is no write access to the parameter
02	The data value exceeds the parameter limits
03	The used sub-index does not exist
04	The parameter is not of the array type
05	The data type does not match the parameter called
06	Only Reset
07	Not changeable
11	No write access
17	Data change in the parameter called is not possible in the present mode of the frequency converter. Some parameters can only be changed when the motor has stopped.
18	Other error
130	There is no bus access to the parameter called
131	Data Change is not possible because factory setup is selected

Modbus RTU Errors	
Modbus Code (decimal)	Meaning
64	Invalid Data Address
65	Invalid Message Length
66	Invalid Data Length or Value
67	Invalid Function Code

■ **Appendix A - Examples**

The following examples illustrate different Modbus RTU commands.

In case of malfunction please refer to the section *Exception Codes*.

■ **EXAMPLE 1: Start Motor, Run Speed 40%**

Modbus function 0F_{HEX} (Force Multiple Coils).

Message sent to Modbus RTU from Modbus master

Byte 0	Byte 1	Byte 2	Byte 3	Byte 4	Byte 5	Byte 6	Byte 7
Slave Address	Function	Coil Addr HI	Coil Addr LO	No. of Coils HI	No. of Coils LO	Byte Count	Force Date HI Coils (0-7)
01	0F	00	00	00	20	04	7C

Byte 8	Byte 9	Byte 10	Byte 11+12
Force Data LO Coils (8-15)	Force Data HI Coils (16-23)	Force Data LO Coils (24-31)	Error Check
04	99	19	[37] [43]

Modbus message string:

[01] [0F] [00] [00] [00] [20] [04] [7C] [04] [99] [19] [37] [43]

[7C]+[04]: Start Command: 0000010001111100 = 047C_{HEX}(reversed)
(See Control Word Bit Descriptions)

Modbus message string:

[01] [0F] [00] [00] [00] [20] [04] [7C] [04] [99] [19] [37] [43]

[99]+[19]: NOTE: Speed Command: 4000_{HEX} = 100% speed
40% of 4000_{HEX} = 1999_{HEX}(reversed)

Message returned to Modbus master from Modbus RTU

Byte 0	Byte 1	Byte 2	Byte 3	Byte 4	Byte 5	Byte 6 + 7
Slave Address	Function	Coil Addr HI	Coil Addr LO	No. of Coils HI	No. of Coils LO	Error Check
01	0F	00	00	00	20	[54] [13]

All values are in hexadecimal.

■ **EXAMPLE 2: Ramp Stop Motor**

Message sent to Modbus RTU from Modbus master

Byte 0	Byte 1	Byte 2	Byte 3	Byte 4	Byte 5	Byte 6	Byte 7
Slave Address	Function	Coil Addr HI	Coil Addr LO	No. of Coils HI	No. of Coils LO	Byte Count	Force Date HI Coils (0-7)
01	0F	00	00	00	20	04	3C

Byte 8	Byte 9	Byte 10	Byte 11+12
Force Data LO Coils (8-15)	Force Data HI Coils (16-23)	Force Data LO Coils (24-31)	Error Check
04	99	19	[89] [19]

VLT® 2800, VLT® 6000 HVAC and VLT® 8000 AQUA Modbus RTU

Modbus message string:

[01] [0F] [00] [00] [00] [20] [04] [3C] [04] [00] [00] [89] [19]

[3C]+[04]: Stop Command: 000001000111100 = 043C_{HEX}(reversed)
 (See Control Word Bit Descriptions)
 Speed Command: 0%

Message returned to Modbus master from Modbus RTU

Byte 0	Byte 1	Byte 2	Byte 3	Byte 4	Byte 5	Byte 6 + 7
Slave Address	Function	Coil Addr HI	Coil Addr LO	No. of Coils HI	No. of Coils LO	Error Check
01	0F	00	00	00	20	[54] [13]

All values are in hexadecimal.

EXAMPLE 3: Coast Stop Motor

Message sent to Modbus RTU from Modbus master

Byte 0	Byte 1	Byte 2	Byte 3	Byte 4	Byte 5	Byte 6	Byte 7
Slave Address	Function	Coil Addr HI	Coil Addr LO	No. of Coils HI	No. of Coils LO	Byte Count	Force Date HI
01	0F	00	00	00	20	04	Coils (0-7) 20

Byte 8	Byte 9	Byte 10	Byte 11+12
Force Data LO	Force Data HI	Force Data LO	Error Check
Coils (8-15)	Coils (16-23)	Coils (24-31)	
04	00	00	[0E] [81]

Modbus message string:

[01] [0F] [00] [00] [00] [20] [20] [2C] [00] [00] [--]

[20]+[2C]: Coast Command: 0010110000100000 = 2C20_{HEX}(reversed)
 (See Control Word Bit Descriptions)
 Speed Command: 0%

Message returned to Modbus master from Modbus RTU

Byte 0	Byte 1	Byte 2	Byte 3	Byte 4	Byte 5	Byte 6 + 7
Slave Address	Function	Coil Addr HI	Coil Addr LO	No. of Coils HI	No. of Coils LO	Error Check
01	0F	00	00	00	20	[54] [13]

All values are in hexadecimal.

VLT® 2800, VLT® 6000 HVAC and VLT® 8000 AQUA Modbus RTU

Message sent to Modbus master from Modbus RTU

Byte 0	Byte 1	Byte 2	Byte 3	Byte 4	Byte 5	Byte 6	Byte 7+8
Slave Address	Function	Byte Count	Data HI (Reg 45140)	Data LO (Reg 45141)	Preset Data LO	Data LO (Reg 45141)	Error Check
01	03	04	00	00	01	2C	--

Byte 3-byte 6: Value 0000012C_{HEX} = 300 = 3 Amps

All values are in hexadecimal.

■ EXAMPLE 6: Read Parameter 609 [8]

"Log: Reference"

This example shows how to read an index parameter. Holding register 9 - Array Index.

Modbus Function 06_{HEX} *Preset Single Register*

Set Array Index to 8

Message sent to Modbus RTU from Modbus master

Byte 0	Byte 1	Byte 2	Byte 3	Byte 4	Byte 5	Byte 6+7
Slave Address	Function	Register Addr HI	Register Addr LO	Preset Data HI	Preset Data LO	Error Check
01	06	00	08	00	08	--

Message sent to Modbus master from Modbus RTU

Byte 0	Byte 1	Byte 2	Byte 3	Byte 4	Byte 5	Byte 6+7
Slave Address	Function	Register Addr HI	Register Addr LO	Preset Data HI	Preset Data LO	Error Check
01	06	00	08	00	08	--

Modbus Function 03_{HEX} *Read Holding register*

Read value of parameter 609 [8]

Message sent to Modbus RTU card from Modbus master

Byte 0	Byte 1	Byte 2	Byte 3	Byte 4	Byte 5	Byte 6+7
Slave Address	Function	Start Addr HI	Start Addr LO	No. of Registers HI	No. of Registers LO	Error Check
01	03	17	69	00	01	--

Message sent to Modbus master from Modbus RTU

Byte 0	Byte 1	Byte 2	Byte 3	Byte 4	Byte 6+7
Slave Address	Function	Byte Count	Data HI	Data LO	Error Check
01	03	02	01	90	--

Note that the starting address of a register is the parameter number x 10 -1 in HEX.

Byte 3+byte 4: 0190_{HEX} = 400 = 40%

All values are in hexadecimal.



www.danfoss.com/drives

Danfoss can accept no responsibility for possible errors in catalogues, brochures and other printed material. Danfoss reserves the right to alter its products without notice. This also applies to products already on order provided that such alterations can be made without subsequential changes being necessary in specifications already agreed. All trademarks in this material are property of the respective companies. Danfoss and the Danfoss logotype are trademarks of Danfoss A/S. All rights reserved.

