

Operating Manual

PacDrive™ Servo drive MC-4

Article Nr.: 17130062-001
Edition: 2005-12



Imprint

© All rights reserved to ELAU AG, also in case of patent right applications.

No part of this documentation and the related software and firm-ware may be reproduced, rewritten, stored on a retrieval system, transmitted or translated into any other language or computer language without the express written consent of ELAU AG.

All possible measures were taken to ensure the that this product documentation is complete and correct. However, since hardware and software are continuously improved, ELAU makes no representations or warranties with respect to the contents of this product documentation.

Trademarks

PacDrive is a registered trademark of ELAU AG.

All other trademarks mentioned are the exclusive property of their manufacturers.

ELAU AG
Dillberg 12
D-97828 Marktheidenfeld
Phone: 09391/606-0
Fax: 09391/606-300
eMail: info@elau.de
Internet: www.elau.de

ELAU Inc.
165 E. Commerce Drive
Schaumburg, IL 60173 - USA
Phone: +1 847 490 4270
Fax: +1 847 490 4206
e-mail: info@elau.com
Internet: www.elau.com

Contents

1	On this manual	5
1.1	Introduction	5
1.2	Symbols, Signs and Forms of Depiction	6
2	General Safety Notes	7
2.1	Basics	7
2.2	Depiction of Safety Notes	8
2.3	Use as Directed	9
2.4	Selection and Qualification of Staff	10
2.5	Residual Risks	10
2.5.1	Installation and Handling	11
2.5.2	Touching Electrical Parts	12
2.5.3	"Safely Separated Low Voltages"	13
2.5.4	Potentially Dangerous Movements	14
3	System Overview	15
3.1	Drive Concepts of Packaging Machines	15
3.2	Structure of the PacDrive™ Automation System	17
3.3	Concept	18
3.4	Components	19
4	Transportation, Storage, Unpacking	21
4.1	Transportation	21
4.2	Storage	21
4.3	Unpacking	22
5	Maintenance	23
5.1	Spare Parts, Components	23
5.2	Repairs	24
5.3	Service Addresses	24
5.4	Exchanging Units	25
5.5	Cleaning	27
5.6	EMC Rules	28
5.7	Commissioning	30
5.8	Configuration / Programming	32
5.8.1	LEDs	33
5.8.2	Example of a diagnosis message	34
5.9	Order Numbers	35

5.9.1	PacDrive MC-4	35
5.9.2	Cable	36
5.9.3	Connector Sets	37
5.9.4	Accessories	38
6	Technical Data	39
6.1	PacDrive MC-4	39
6.1.1	In General	40
6.1.2	Interface	47
6.1.3	Electrical Connections	48
6.1.4	Dimensions	53
6.2	PacDrive BM-4	58
6.2.1	In General	58
6.2.2	Display and operating units	58
6.2.3	Interface	59
6.2.4	Electrical Connections	60
6.2.5	Dimensions	61
6.3	PacDrive Mains Filter	62
6.3.1	In General	62
6.3.2	Electrical Connections	63
6.3.3	Electrical Connections	64
6.4	PacDrive Mains Choke	65
6.4.1	Application of mains choke	65
6.4.2	Dimensions	66
7	APPENDIX	67
7.1	Contact Addresses	67
7.2	Further Literature	68
7.3	Product Training	70
7.4	Declaration by the manufacturer	71
7.5	Safety Checks	72
7.6	Hard-/Software Compatibility list	73
7.7	Modifications	74
7.8	Index	75
7.9	Form for Error Report	77

1 On this manual

1.1 Introduction

Before using ELAU components for the first time, you should familiarize yourself with this operating manual.

In particular, observe the safety notes described in chapter 2.

Only persons who meet the criteria for "Selection and Qualification of Staff" (see chapter 2.4) are allowed to work on ELAU components.

One copy of this manual has to be available for staff working on the components at all times.

This manual helps you use the component safely and expertly and as directed.

Observe this manual. This will help to avoid risks, reduce repair costs and down times and increase the lifetime and reliability of the products.

You also need to observe the valid rules for the prevention of accidents and for environmental protection in the country and place where the device is used.

1.2 Symbols, Signs and Forms of Depiction

The following symbols and signs are used in this document:



Depiction	Meaning
■	First level enumeration sign.
–	Second level enumeration sign.
▶	Action symbol: The text following this symbol includes an instruction for action. Execute the instruction actions in the given order, from top to bottom.
✓	Result symbol: The text following this symbol contains the result of an action.
<i>Italics</i>	If the describing text contains special terms (e.g. parameters) then they are written in italics.
Serif font	If the manual contains program code, it is marked by Serif font.
	Information symbol: This symbol marks notes and useful tips for using the product.
	Warning sign: Safety notes can be found in the relevant places. They are marked with this symbol.
	After this symbol, information about contents of the chapter follows as guideline assistance.

Table 1-1: Symbols, signs and forms of depiction

2 General Safety Notes



This chapter contains general requirements for working safely. Every person using ELAU components or working on ELAU components has to read and observe these general safety notes. If activities involve a residual risk, you will find a clear note in the respective places. The note describes the risk that may occur and preventive measures to avoid that risk.

2.1 Basics

The ELAU components are built according to the state of technology and generally accepted safety rules. Nevertheless, their use may cause a risk to life and limb or material damage if:

- you do not use the components as directed
- work on the components is not done by experts or instructed staff
- you inexpertly alter or modify a component
- you fail to test the protective measures in place after installation, commissioning or servicing
- you do not observe the safety notes and regulations.

Only operate the components in perfect technical condition as directed, in regard to safety and risks and observe this manual.

The flawless and safe operation of the components requires appropriate transport, storage, mounting and installation as well as careful maintenance.

In case of any circumstances that impair the safety and cause changes in the operating behavior, immediately put the component(s) to a stop and inform the service staff in charge.

In addition to this manual, observe

- the prohibiting warning and mandatory signs on the component, the connected components and in the switching cabinet
- the relevant laws and regulations
- the operating manuals of the other components
- the universally valid local and national rules for safety and the prevention of accidents.

2.2 Depiction of Safety Notes

Risk categories

The safety notes in this manual are grouped into different risk categories. The table below shows which risk and possible consequences the symbol (pictograph) and the signal words indicate.

Pictograph	Signal word	Definition
	DANGER!	Indicates an immediately dangerous situation that will result in death or very serious injuries if the safety rules are not observed.
	WARNING!	Indicates a possible dangerous situation that can result in serious injuries or major material damage if the safety rules are not observed.
	CAUTION!	Indicates a possible dangerous situation that might result in material damage if the safety rules are not observed.

Table 2-1: Risk categories

2.3 Use as Directed

The ELAU components are designed for installation in a machine/plant or for combination with other components to form a machine/plant. The components may only be used under the installation and operating conditions described in this documentation. You must use the accessories and ancillary parts (components, cables, etc.) mentioned in the documentation. You must not use any foreign objects or components that are not explicitly approved by ELAU.

"Use as directed" also means that you

- observe the Operating Manuals and other documentations (see appendix),
- observe the instructions for inspection and maintenance.

Use other than directed

The operating conditions at the installation location must be checked on the basis of the given technical data (performance information and ambient conditions) and observed.

The device must not be put into operation until it is guaranteed that the useable machine or the plant in which the motor is installed meets in its entirety EC directive 98/37/EC (machine directive).

In addition, observe the following norms, directives and regulations:

- DIN EN 60204 Safety of machines:
Electrical equipment of machines.
- DIN EN 292 part 1 and part 2 Safety of machines:
Basics, general design guidelines.
- DIN EN 50178 Equipment of high-voltage plants with electronic operating means.
- EMC directive 89/336/EEC

2.4 Selection and Qualification of Staff

This manual is aimed exclusively at technically qualified staff with detailed knowledge in the field of automation technology.

Only qualified staff can recognize the significance of safety notes and implement them accordingly.

This manual is aimed in particular at design and application engineers in the fields of mechanical and electrical engineering, at programmers, service and commissioning engineers.

Working on electrical equipment

Work on electrical equipment must only be done by qualified electricians or by instructed staff supervised by an electrician according to the electrotechnical rules.

An electrician is a person who due to his vocational training, know-how and experience as well as knowledge of the valid regulations, is able to:

- evaluate the work he is supposed to do
- identify potential risks
- implement suitable safety measures.

2.5 Residual Risks

We minimized the health risk for people by means of appropriate construction and safety technology. Nevertheless, there is a residual risk, since the components work with electrical current and voltage.

2.5.1 Installation and Handling



WARNING!

Risk of injury while handling the unit!

Risk of injury due to squeezing, cutting or hitting!

- Observe the universally valid construction and safety rules for handling and installation.
 - Use suitable installation and transport facilities and use them professionally. If necessary, use special tools.
 - Take precautions against squeezing.
 - If necessary, use suitable protective clothing (e.g. safety glasses, safety shoes, protective gloves).
 - Do not stay under pending loads.
 - Remove any leaking liquids from the floor immediately to avoid skidding.
-

2.5.2 Touching Electrical Parts

Touching parts carrying a voltage of 50 Volts or higher can be dangerous. When electric appliances are operated, certain parts of these appliances inevitably carry a dangerous voltage.



DANGER!

High voltage!

Life hazard!

- Observe the valid construction and safety regulations for working on high-voltage units.
 - After installation, check the fixed connection of the earth conductor on all electric appliances according to the connection plan.
 - Operation, even for short-term measuring and test purposes, is only permitted with an earth conductor firmly connected to all electric components.
 - Disconnect the unit from mains or power supply and lock it out before accessing electrical parts with voltages exceeding 50 Volts. After switching off, wait at least 5 minutes before touching any components.
 - Do not touch electrical connections of the components while the unit is on.
 - Before switching the unit on, cover all voltage carrying parts to prevent accidental contact.
 - Provide a protection against indirect touching (EN 50178 / 1998 section 5.3.2).
-



DANGER!

High leak current!

Life hazard!

- The leak current is greater than 3.5 mA. Therefore the units must have a firm connection to the power grid (according to DIN EN 50178 / 1998 - equipment of high-voltage systems).
-

2.5.3 "Safely Separated Low Voltages"

PELV
*Protective-Extra-
Low-Voltage*

Signal voltage and control voltage of the PacDrive units are <33 V. In this range, the specification as PELV system according to IEC 364-4-41 includes a protective measure against directly and indirectly touching dangerous voltages by means of a "safe separation" from the primary to the secondary side in the plant/machine. ELAU urgently recommends to execute the plant/machine with safe separation.



DANGER!

High voltage due to wrong connection!

Life hazard or risk of serious injury!

- Only units, electric components or cables with a sufficient safe separation of the connected power supplies according to EN 50178 / 1998 (equipment of high-voltage systems with electronic operating means) may be connected to the signal voltage connections of these components.
- Make sure that the existing safe separation is retained throughout the entire current circuit.

FELV
*Functional-
Extra-Low-
Voltage*

When using ELAU components in systems that do not include a safe separation as a means of protection against directly or indirectly touching dangerous voltages, all connections and contacts (e.g. MAX-4, Sub-D connector, serial interface) that do not comply with protection class IP2X must be permanently covered. The cover or device connection must be arranged such, that it can only be removed with the help of a tool. The protective measure must be observed on all connected devices.

2.5.4 Potentially Dangerous Movements

There can be different causes for potentially dangerous movements:

- mistakes in wiring or cable connection
- software errors
- faulty components
- errors in measuring value and signal encoders
- operating mistakes

The protection of people must be insured by superior means or monitoring on the plant side. You must not rely on the internal monitoring in the drive components alone. Monitoring or measures must be provided according to a risk and error analysis by the plant builder according to the specific conditions of the plant. The valid safety rules for the plant have to be included in this process.



DANGER!

Potentially dangerous movements!

Life hazard, serious injury or material damage!

- No persons are allowed within the motion range of the machine. This must be ensured with devices like protective fences, grids, covers or photoelectric barriers.
 - The fences and covers must be sufficiently strong to withstand the maximum possible motion energy.
 - The emergency stop switch must be located very close to the operator. Check the operation of the emergency stop before starting up the plant.
 - Secure against unintentional start by enabling the mains contactor of the drives via an emergency off circuit or by means of the function 'safe stop'.
 - Before accessing the danger zone, bring the drives to a safe stop.
 - To work on the plant, the power must be turned off and locked out.
 - Avoid operating high-frequency remote-control and radio devices in the vicinity of the plant's electronics and connecting wires. If the use of those devices is inevitable, check system and plant for possible malfunctions before the first operation. In some cases, a special EMT check may be necessary.
-

3 System Overview

3.1 Drive Concepts of Packaging Machines

Modern machine concepts in the packaging industry are characterized by the need for high dynamism, flexibility, modularity and efficiency. Packaging machines were traditionally equipped with a mechanical vertical shaft, which drove the secondary motions in the machine, usually with mechanical components with complicated motion functions. Designing such a machine, flexible for different products is a highly complex task. Even minor changes in the packaging process, particularly in case of a product change, require major modifications and standstill time.

Packaging machines with electronic vertical shafts permit full flexibility. Electronic servo drive systems replace cam and coupling gears and a virtual electronic vertical shaft ensures that the motion axes are synchronous. Any pulse and angle synchronous movements are determined by a central control.

Unplanned machine states, such as stop or emergency off situations or initialization movements can be realized synchronously. Dynamic changes of the goods to be packed or the packaging material in the plant, (like slippage of the products to be packed or expansion of the packaging material) can be registered by sensors while the machine is running and eliminated by modifying the corresponding drive movements. This development substantially changes and highly simplifies the classical mechanical machine concept. The structure of the packaging machine can be broken down into modules that are easy to apply and can be standardized.

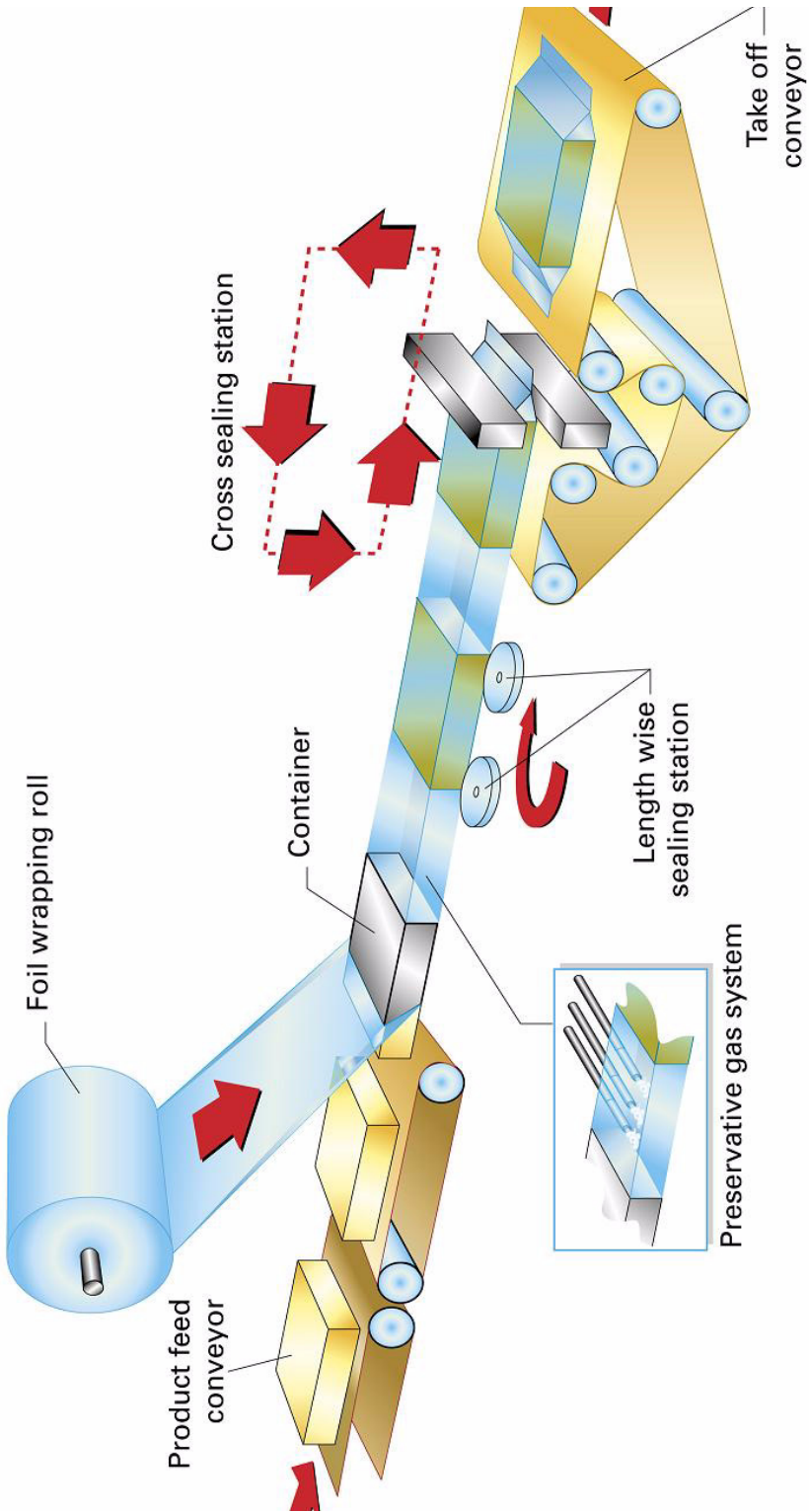

Fig. 3-1: Sketch of a packaging machine

3.2 Structure of the PacDrive™ Automation System

The PacDrive™ automation system offers a technically and economically optimal solution for electronic packaging machines. PacDrive™ consists of an efficient PC-based control, the PacDrive Controller and the digital MC-4 servo drive which include the mains connection unit, the end-stage power and the servo regulator of the individual axes (Fig. 3-2).

The PacDrive Controller is the intelligent head of the system, and is based on an industrial PC. The PacDrive Controller synchronizes and coordinates the motion functions of the packaging machine. Using an IEC 1131-3 soft PLC, it ventures into applications previously reserved for standard PLCs. The individual PLC or positioning tasks can be broken down into several parallel tasks, which are implemented with the EPAS-4 programming environment according to the IEC 1131-3 standard. Up to 40 servo axes can be connected to a PacDrive Controller and supplied with positioning data.

The circular digital SERCOS real-time bus realizes the safe data exchange with the servo drive MC-4. Due to the use of optical fiber technology, the data bus is insensitive to electromagnetic disturbances and cyclically supplies the decentralized servo drive MC-4 with new set values at a data rate of 4MBaud. All internal states of the axes can be checked via the real-time bus and processed in the PacDrive Controller.

In addition to digital and analog inputs and outputs, the PacDrive Controller has two serial interfaces and one Ethernet interface. A variety of process visualization and control systems can be connected to the PacDrive™ system via the integrated OPC interface. Further peripheral components can be connected via field bus interface modules. The PacDrive Controller can act as a field bus master or slave.

The international field bus standards CANopen, PROFIBUS-DP and DeviceNet are supported. The built-in interfaces enable remote diagnosis via telephone modem or Internet. Via TCP/IP, PC's can communicate with the PacDrive Controller and diagnose the state of the control directly.

3.3 Concept

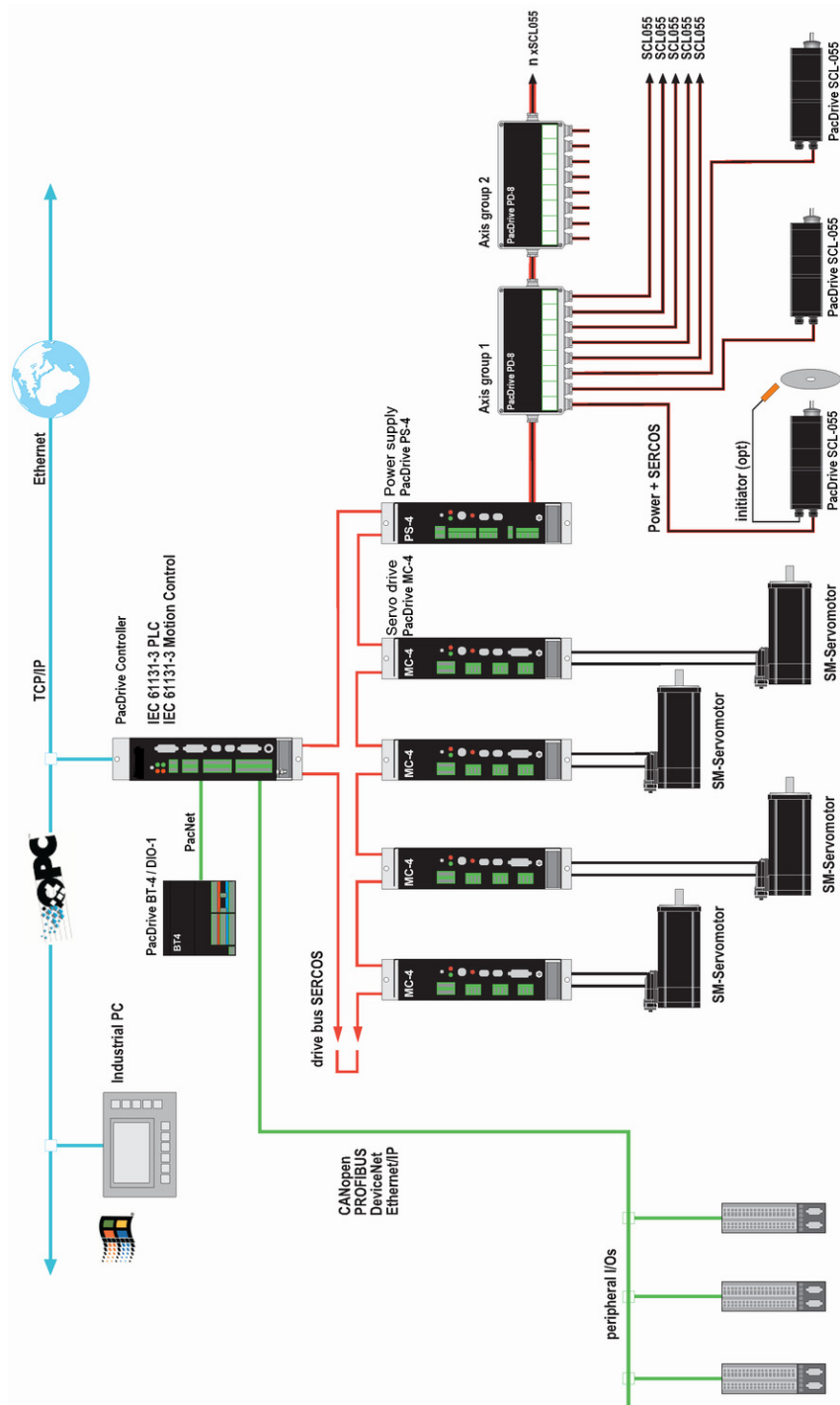

Fig. 3-2: System overview of the PacDrive™ automation concept

Alternatively, the PacDrive Controller can be connected to a conventional PLC via a field bus.

3.4 Components

Automation Toolkit EPAS-4

EPAS-4 has extensive and proven functions and tools. A key advantage of EPAS-4 is, that all components are integrated and intuitive.

For you as a user this means:

Quick familiarization, easy handling, all tools integrated.

Libraries ELAU maintains extensive libraries geared to the packaging industry, helping you obtain cost effective and speedy answers to any concern. They will also help you to improve the quality of your user programs.

Highlights of the EPAS-4 Automation Toolkit

- Runs under Windows (recommended WinXP)
- Programming language IEC 61131-3
- SCOPE tool (oscilloscope functions)
- Diagnostic tool
- very good debugging features
- serial or TCP/IP connection to the PacDrive Controller.

PacDrive Controller Family

The PacDrive Controller, a microprocessor-based control hardware with VxWorks real-time operating system, realizes the PLC and motion functions.

A PacDrive Controller synchronizes, coordinates and generates the positioning functions for a maximum of:

- 8 drives PacDrive Controller MAx-4 / 8
- 8 drives PacDrive Controller C200
- 16 drives PacDrive Controller C400
- 99 drives PacDrive Controller MAx-4 / 99
- 99 drives PacDrive Controller C600
- 22 drives PacDrive Controller P600

in a food and packaging machine.

For HMI tasks, various standard HMIs are used. Whether low-cost clear text or IPC - it's no problem for the flexible PacDrive Controller.

The PacDrive Controller P600 is equipped with a complete PC. Due to this PC based technologie, the P600 can also be used for HMI applications.

Servo drive PacDrive MC-4

Leading-edge technology The digital servo drive MC-4 is characterised by its compact and autonomous structure, suitable for wall mounting as well as its leading-edge technology. The innovative MC-4 has the mains supply unit, end stage and software regulator for one axis integrated in a compact casing. Since it communicates with the PacDrive Controller only via fibre optical cable, it is also suitable for a decentralized structure. It requires no user program. It comes with single- and multi-turn processing features as standard and configures itself with the help of the electronic name plate in the SM motor.

The highlights of the MC-4 MotorController

- World-wide voltage range
- Integrated mains supply unit
- Max. power 34.5 / 69 kVA
- Automatic motor recognition
- Minimum size
- Safety input Inverter Enable
- 250 % overload
- Integrated SERCOS interface
- few types

SM-Motor

Highly dynamic servo motors Machines with fast cycle rates require highly dynamic AC servo motors. The SM motor series offers you as a user an optimum motor concept for your food and packaging machines. The dynamic brushless servo motors are furnished with high-resolution encoders (single-turn or multi-turn) and electronic name plate. Smooth surface and compact size meets the requirements of the target market.

The highlights of the SM motors

- Low mass moment of inertia
- 4-fold overload
- Reliable high-voltage technology
- Leading-edge magnetic technology
- High-resolution single- or multi-turn encoder
- Electronic name plate
- Plug in junction box
- IP 65 protection

4 Transportation, Storage, Unpacking

4.1 Transportation

- ▶ Avoid shocks.
- ▶ Immediately check units for transport damage and inform your transport company, if necessary.

4.2 Storage

- ▶ Store units in a clean, dry place.

Storage conditions:

- air temperature between - 25 °C and + 70 °C.
- temperature fluctuations max. 30 K per hour.

4.3 Unpacking

- ▶ Check whether the delivery is complete.
- ▶ Check all units for transport damage.

Type plate

The type plate contains all necessary information:



Fig. 4-1: Type plate on PacDrive MC-4

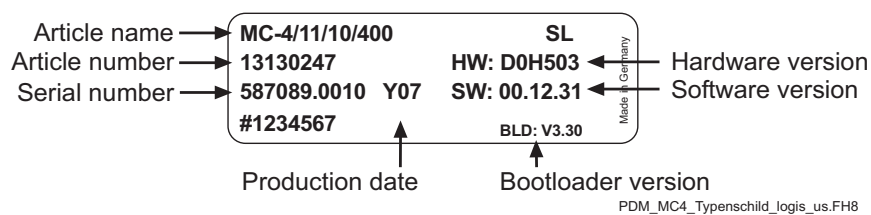

Fig. 4-2: logistic type plate of a PacDrive MC-4

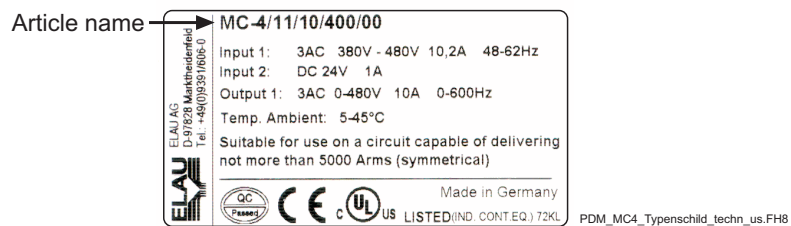

Fig. 4-3: technical type plate of a PacDrive MC-4

5 Maintenance

Recognizing and clearing an error quickly helps to keep the related production loss down to a minimum.

The diagnosis messages of the PacDrive™ system, which can be checked using EPAS-4, make it possible to look for errors deliberately and effectively.

In case of an error, defective components can be exchanged with no problem. This ensures that the problem can be solved quickly and operation can be resumed soon. This work must be done by qualified maintenance staff only.

When returning a defective unit to the ELAU customer service, please complete the attached error report form.

5.1 Spare Parts, Components

Stock keeping of spare parts:

Keeping a stock of the essential components is a key prerequisite for the permanent functionality of the equipment.



ATTENTION!

Device compatibility!

System does not operate accurately after exchanging components.

- Only units with identical hardware configuration and identical software version may be exchanged.

When ordering spare parts, please give the following data:

product name:	e. g. MC-4/11/10/400
article number:	e. g. 13130247
hardware version:	e. g. HW: 504001
software version:	e. g. SW: 00.05.00



NOTE

You can find this information on the type plate of the equipment (see Fig. 4-2) and in the configuration of the PacDrive™ systems.

5.2 Repairs

By all means complete the attached error report form when returning defective components.

You can also make a photocopy of the error report form and use it as a fax message.



ATTENTION!

Electro static discharge!

Components may be damaged!

- Electronic parts may only be returned in the original or a comparable packaging. In any case the components must be wrapped in an ESD packaging/foil. Otherwise you will lose your warranty rights.
-

5.3 Service Addresses

For ordering spare parts

ELAU AG
Postfach 1255
97821 Marktheidenfeld
Phone: +49 (0) 9391 / 606 - 0
Fax: +49 (0) 9391 / 606 - 300

Repairs and Servicing

Please send the components to be repaired or checked, along with the error report, to this address:

ELAU AG
Abt. Kundendienst
postal address: house address:
Postfach 1255 Dillberg 12
97821 Marktheidenfeld 97828 Marktheidenfeld
Phone: +49 (0) 9391 / 606 - 142
Fax: +49 (0) 9391 / 606 - 340

Service team

Should you need to talk to a member of our service team or require on-site service, please contact:

ELAU AG
Abt. Applikation
Postfach 1255
97821 Marktheidenfeld
Phone: +49 (0) 9391 / 606 - 0
Fax: +49 (0) 9391 / 606 - 300

5.4 Exchanging Units

In addition to the notes below, please observe the information of the machine producer when exchanging the PacDrive MC-4.



DANGER!

High Voltage!

Life Hazard!

High voltage possible with servo motors in generator operation!

- Before working on electrical units, disconnect from mains supply and secure against switch-on.
- Make sure that the drives are standing still.
- Do not disconnect connector plugs while they are carrying voltage.
- Before working on the unit, discharge the DC-circuit and use a voltmeter to check that there is no voltage.



CAUTION!

Electro static discharge!

Components may be damaged!

- Only touch the boards on the edges. Do not touch any connections or components.
- Existing static charges can be discharged by touching a grounded metallic surface, e.g. a grounded equipment casing.
- Prevent the development of electrostatic charge by using suitable clothing, carpets or furniture and by moving the boards as little as possible.

Exchange PacDrive MC-4

- ▶ lift the main switch
- ▶ secure against switch-on



DANGER!

Dangerous electrical voltages also after the separation from the network!

Life hazard!

- Wait at least two minutes after the separation from the network, until the inserted condensers are unloaded.
- Check whether the voltages sank after the two minutes to a harmless value.
- Performance plug connectors of the cables only in status without tension of the system separate or join!



CAUTION!

Hot surfaces on the PacDrive MC-4 and the brake modules (BM-4)!
Burn danger!

- Wait for the MotorController or the brake modules to cool down by itself or use the protective gloves.

-
- ▶ Separate the access lines of the PacDrive MC-4.
 - ▶ Screws at upper housing and lower surface loosened.
 - ▶ Remove PacDrive MC-4.
 - ▶ Insert new PacDrive MC-4 and tighten the screws.
 - ▶ Attach the new PacDrive MC-4 according to the machine connection diagram.
 - ▶ System in operation set again.

Exchange motor

- lift the main switch
- secure against switch-on



DANGER!

High voltage!
Life hazard!

- Performance plug connectors of the cables only in status without tension of the system separate or join!



CAUTION!

Mechanical force!
Damage of the encoder system is possible!

- When removing and applying clutches on the motor shaft no impact may be executed on the motor shaft, since otherwise the encoder will be damaged. Use suitable tools e. g. pullers.
-

**WARNING!**

Inadvertent on movements!

Danger of accident!

- With servo axles with indirect distance measurement system over the motor encoder the measure reference is lost with exchange of the engine!
The measure reference to the machine coordinate system is to be reconstituted therefore after the exchange again!

- ▶ While exchange of a motor the specification of the machine manufacturer is to be considered.
- ▶ During indirect entry of the position actual values over the motor-own measuring system the measure reference must again be reconstituted.

Exchange cable

- ▶ lift the main switch
- ▶ secure against switch-on

**DANGER!**

High voltage!

Life hazard!

- Separate or join the plug connectors of the cables only in status without power on the system!
- Performance plug connectors only with dry and clean putting pages join!
- If no finished manufactured cables are used by ELAU, allocation of new cables for agreement with the connection diagram of the machine manufacturer to check!

- ▶ During the exchange of cables the specification of the machine manufacturer is to be considered.

5.5 **Cleaning**

With suitable installation the devices are to a large extend maintenance-free.

Dust and foreign bodies, which are near-carried particularly by the cooling air flow, can be removed, as the devices are removed after the unstressed switching and with dry compressed air (max. 1 bar) are blown out.

5.6 EMC Rules

To control and regulate motors, the mains voltage is stored in the DC-circuit of the servo drives by means of rectification. This stored energy is fed to the motor by deliberately switching on and off six semiconductor switches. The steep rise and fall of the voltage puts high demands on the insulation strength of the motor winding. Another essential aspect to be considered is the Electro Magnetic Compatibility (EMC) with other system components. The flank steepness of the clocked voltage generates harmonic oscillations of great intensity, up into the high-frequency range.

Therefore observe the following EMC rules:

- Choose the earthing option with the lowest possible ohm rate (e.g. unpainted mounting board of the switching cabinet) for installation.
- Contact the largest possible surface (skin effect). If necessary, remove existing paint to achieve large-surface contact.
- From the Central Earthing Point (CEP), lay earthing wires to the respective connections in a star structure. Earthing circuits are not admissible and can cause unnecessary distortions.
- Use shielded cables only.
- Only large-surface shield transitions are admissible.
- Shields must not be contacted via pin contacts of connector plugs.
- By all means observe the switching proposals.
- Cut motor cables to minimum length.
- Do not lay cable circuits inside the switching cabinet.



CAUTION!

Electromagnetic fields!

Disturbances or failure of the system possible!

With the installation following rules must be considered, in order to exclude consequences of excessive disturbance effects as far as possible.

- In connection with electronic controls, no inductive loads whatsoever must be switched without suitable interference elimination.
- For DC operation, suitable interference elimination can be achieved by arranging recovery diodes. For AC operation, commercially available erasing elements matching the connector type can be used.
- Only the interference elimination element mounted immediately at the point of inductivity serves this purpose. In any other case, the switching pulse may even emit increased interference via the interference elimination elements. It is much easier to avoid sources of interference in the first place, than to eliminate the effects of existing interference.
- In no case must the contacts switching unshielded inductive loads be arranged in the same room as the PacDrive MC-4; the same goes for cables carrying unshielded, switched inductivity and cables running parallel to them. The control must be separated from such „disorders“ by a Faraday cage (own section in the switching cabinet).



CAUTION!

Electromagnetic fields!

Disturbances or failure of the system possible!

- Depend on the combination servo drive / motor and the cable length are to be used possibly system filters or motor filters. Consider for this the projecting manual for the PacDrive™ system.
-

5.7 Commissioning

We recommend to take up first with ELAU commissioning personnel.

This is not only occur for guarantee reasons, but also

- the equipment check,
- which determines optimal configuration,
- the service personnel is instructed at the same time.

Commissioning procedure:



CAUTION!

The PacDrive units (MC-4, MAx-4, etc.) may be damaged by inexperienced installation work!

Possible material damage!

Every person working on the plant / machine / switching cabinet in which PacDrive components are installed must make sure that no objects (e.g. chips, screws, etc.) fall into the ventilation slots of the equipment (in particular, watch the top side!).

- Finish all installation work such as drilling, screwing etc. before you start mounting the units.
 - If installation work is necessary after the PacDrive units have been mounted, by all means cover the units with due care (IP20).
-

Unpacking and checking

- ▶ Remove packaging.
- ▶ Make sure the units are not damaged. Only undamaged units should be put into operation.
- ▶ Check if the consignment is complete.
- ▶ Check if the optional slots are occupied correctly.
- ▶ Check the data with the help of the type plate.

See also chapter „Transportation, Storage, Unpacking“.

Installation

- ▶ Observe the requirements for the place in which the equipment may be used.
- ▶ Observe the requirements for protection and EMC rules.
- ▶ Mount devices.

See also chapter „Maintenance“.



DANGER!

High leak current!

Life hazard!

- The leak current is greater than 3.5 mA. Therefore the units must have a firm connection to the power grid (according to DIN EN 50178 - equipment of high-voltage systems).
-

Electrical installation

- ▶ Connect the units, starting with the ground conductor.
- ▶ Make sure the clamps are tight and the required cable cross sections are correct.
- ▶ Make sure the shield is executed correctly, rule out short-circuits and interruptions.

See also chapter „Technical Data“and „Maintenance“

Connecting the control voltage (24V)

- ▶ Check mains and control voltage.
- ▶ Connect external 24 V control voltage.
- ✓ The units initialize themselves and the LEDs should show the following state:
 - MAx-4: pow: ON, err: ON, buserr: ON, wd: OFF
 - MC-4: pow: ON, err: flashing, buserr: ON

See also chapter „Technical Data“

Checking the safety functions

- ▶ Check thermo contact of the motor or PTC (see operating manuals for the connected components).
- ▶ Check the functions of the brake (if any).
- ▶ Check EMERGENCY OFF chain and EMERGENCY OFF switch.

Connecting the mains voltage

- ▶ Activate EMERGENCY OFF switch.
- ▶ Connect mains voltage.
- ▶ Check if the state indicator works correctly.
- ▶ Deactivate EMERGENCY OFF switch.

Moving the axis

- ▶ When you move the axis for the first time, use a reliable small user program in order to check:
 - the correct turning direction of the axis
 - the correct setting of the limit switches
 - the brake path in both directions.

**NOTE**

When the 24V control voltage is connected, the servo amplifier MC-4 automatically detects the motor and corresponding motor data.

Configuration and program transmission.

- ▶ Transmit the project to the PacDrive Controller with the Automation Toolkit EPAS-4.



DANGER!

Potentially dangerous movements!

Life hazard, risk of serious injury or material damage!

- Make sure that there are no persons in the danger zone.
 - Remove from the motion range all tools, loose parts and other auxiliaries that do not form part of the axis/machine/plant. (Make sure the plant is ready for operation)
 - ELAU recommends not to couple the working machine until the function test has been completed successfully!
-

Testing the functionality

- ▶ Check units and cabling again.
- ▶ If it has not been done already, connect the mains voltage
- ▶ Run function check by means of a check list for axis/machine/plant functions.

Further commissioning of the plant

- ▶ Continue to commission the plant according to the operating manual of the machine producer.

5.8 Configuration / Programming

The adjustment of the PacDrive™ system to their function takes place with the automation toolkit EPAS-4.

In EPAS-4 the system is configured and programmed after IEC 61131-3.



NOTE

For further details on diagnosis, please consult the online help of the Automation Toolkit EPAS-4.



CAUTION!

Complex functionality of the PacDrive™ system and the machine!
Damage possible!

- Program modifications may be executed only by trained personnel with detailed knowledge of the system. Modifications may be made therefore only by your machine supplier or by ELAU coworkers. The ELAU AG is not responsible for damage by arbitrary program modifications.
-

5.8.1 LEDs

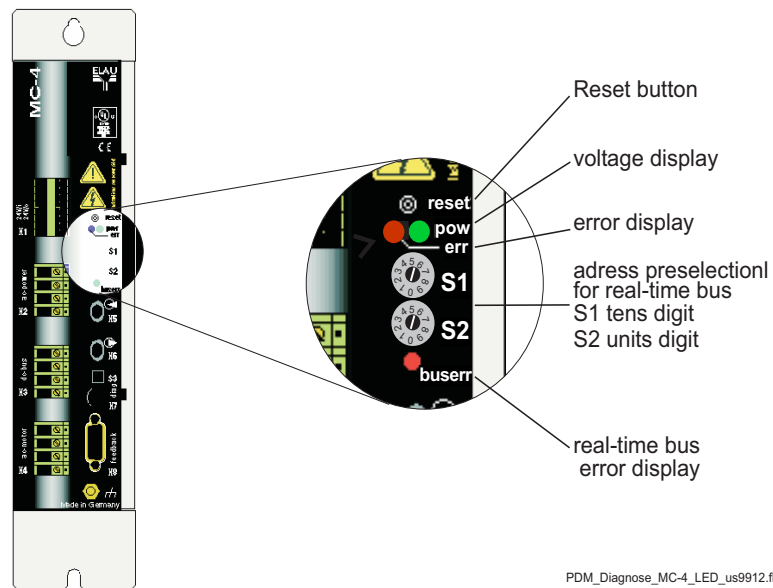

PDM_Diagnose_MC-4_LED_us9912.fn8

Fig. 5-1: Diagnosis LEDs of the PacDrive MC-4



pow (control voltage display)

The LED „pow“ signals the condition of the control voltage.

OFF	control voltage (24 V) missing or too low.
ON	normal operation; control voltage in normal range



err (error indicator)

The Error-LED (err) is used for the error display. The following index shows possible display states with the associated error report.

OFF	normal operation
Flashing slowly (1 Hz)	general error
Flashing fast (2 Hz)	SERCOS error
ON	serious system error



bus err (SERCOS bus error display)

OFF	normal operation
ON	bus error (fiber-optic connection problem, e. g. transmitting power too low or too high, cable break, ...)

S1 / S2 SERCOS address switches

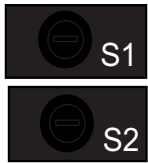

Use the rotary type switches S1 and S2 to set the SERCOS address (0-99) of the servo amplifier MC-4. The tens digit is set with switch S1. The singles digit is set with switch S2.

S3 fiber-optic intensity



The sender intensity of the fiber-optic light source is set on the PacDrive MC-4 with the DIL switches S3 on the front side. The sender intensity depends on the length of the cable up to the next slave..

cable length [meter]	intensity
0.1 - 1	1
1.1 - 20	2
20.1 - 40	3
40.1 - 50	4

Table 5-1: Fiber-optic intensity with dedicated cable length

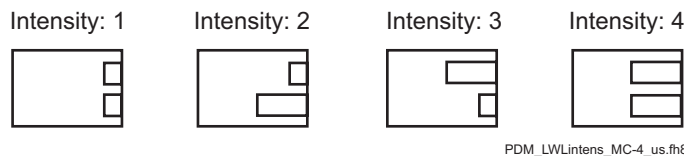

PDM_LWLintens_MC-4_us.fth8

Fig. 5-2: Positioning switch on the front panel of the PacDrive MC-4

reset



Button to reset the servo amplifier MC-4. Only the servo amplifier is rebooted if you activate the „reset“ button. Other PacDrive Controllers MAX-4, C200 etc. that may be connected have their own „reset“ buttons.

5.8.2 Example of a diagnosis message

The diagnosis message 121 „Bleeder temperature too high“ is shown.

Meaning of the diagnosis message:

- Class 2 error
- Diagnosis code 121

The meaning of the diagnosis code is further explained in the online help of the Automation Toolkits EPAS-4.

121 Bleeder temperature too high

- The bleeder is overloaded.

- Cause** The drive is dimensioned incorrectly.
- Solution** Check drive dimensioning.
- Cause** Hardware error: Bleeder or control is defective.
- Solution** Contact our customer service.

5.9 Order Numbers

5.9.1 PacDrive MC-4

Type key

HW-Identifier
11

Rated current
e.g. 03 = 3 A

Rated voltage
230 = 230 V
400 = 400 V (3 external ducts)

MC-4 / 11 / 10 / 400

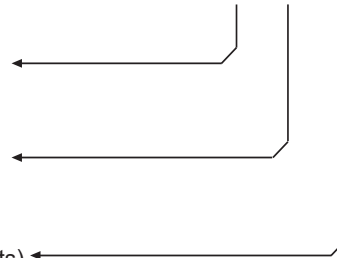

Order number	Product name	Explanation
13 13 02 44	MC-4 / 11 / 01 / 400	MC-4 1.5 A 400 V
13 13 02 45	MC-4 / 11 / 03 / 400	MC-4 3 A 400 V
13 13 02 46	MC-4 / 11 / 05 / 230	MC-4 5 A 230 V
13 13 02 47	MC-4 / 11 / 10 / 400	MC-4 10 A 400 V
13 13 02 54	MC-4 / 11 / 22 / 400	MC-4 22 A 400 V
13 13 02 56	MC-4 / 11 / 50 / 400	MC-4 50 A 400 V

Table 5-2: Order numbers and variants for MC-4

5.9.2 Cable

Motor cables

Order number	Product name	Explanations
15 15 41 01	E-MO-067 UL cable 1,5 mm ²	SM-070/100 on MC-4 X4
15 15 41 21	E-MO-092 UL cable 1,5 mm ²	SM-140 on MC-4 X4
15 15 41 12	E-MO-082 UL cable 2,5 mm ²	SM-140/30/210/.. with fan on MC-4 / 22 A X4
15 15 41 17	E-MO-087 UL cable 2,5 mm ²	SM-140/30/290; SM-140/30/370 on MC-4 / 22 A X4
15 15 41 20	E-MO-091 UL cable 4 mm ²	SM-140/30/370/.. with fan on MC-4 / 22 A X4 on MC-4 / 50 A X4
15 15 41 02	E-MO-068 CE cable 1,5 mm ²	SM-070/100 on MC-4 X4
15 15 41 07	E-MO-073 CE cable 1,5 mm ²	SM-140 on MC-4 X4
15 15 41 03	E-MO-069 CE cable 2,5 mm ²	SM-140/30/210/.. with fan on MC-4 / 22 A X4
15 15 41 11	E-MO-081	SB 205 with plug 2,5 mm ² on MC-4 X4
15 15 41 13	E-MO-083 CE cable 2,5 mm ²	SM-140/30/290; SM-140/30/370 on MC-4 / 22 A X4
15 15 41 14	E-MO-084 CE cable 4 mm ²	(SM-140/30/370/.. with fan) on MC-4 / 22 A X4 on MC-4 / 50 A X4
15 15 41 15-XXX	E-MO-085 SM 1.5	on MC-4 X4 CE cable
15 15 41 16-XXX	E-MO-086 SM 1.5	SR-058 on MC-4 X4 UL cable
15 15 41 19	E-MO-090	SB-205 with connection box 10 mm ² on MC-4 / 50 A X4
15 15 41 27 - XXX	E - MO - 111 Kabel 2.5 mm ²	SH055, 070, 100 and SH140/30/120, /200 plug small, short
15 15 41 28 - XXX	E - MO - 112 Kabel 2.5 mm ²	SH055, 070, 100 and SH140/30/120, /200 plug small, long
15 15 41 29 - XXX	E - MO - 113 Kabel 2.5 mm ²	SH140/30/270, /330 plug large

Table 5-3: Order numbers for motor cables

Encoder cables

Order number	Product name	Explanations
15 15 42 01	E-FB-060 UL cable	SM-070; SM-100 X4 on MC-4 X8
15 15 42 02	E-FB-061 CE cable	SM-070; SM-100 X4 on MC-4 X8
15 15 42 06	E-FB-064	SB-Motor MIL Stift MC-4 X8
15 15 42 11-XXX	E-FB-065 MAX-SIN-ME UL	on MAX-4 X9
15 15 42 12-XXX	E-FB-066 MAX-SIN-ME	on MAX-4 X9
15 15 42 13-XXX	E-FB-069 SM/SIN	Extension motor side SM070/100
15 15 42 14-XXX	E-FB-070 SM/SIN	UL cable SR-058 on MC-4 X8
15 15 42 15	E-FB-071 UL cable	SM-140 X4 on MC-4 X8
15 15 42 17	E-FB-073 CE cable	SM-140 X4 on MC-4 X8
15 15 20 08	E-FB-028	Incremental encoder on MAX-4 / INC-4
15 15 42 23 - XXX	E - FB - 080	all SH-Motors

Table 5-4: Order numbers for encoder cables

Interface cables

Order number	Product name	Explanations
15 15 43 01	E-SS-054 (PC)	on MAX-4 X5 (COM 1)
15 15 43 03-XXX	E-SS-056 REAL-TIME-BUS	on MC-4 X5
15 15 43 04-030	E-SS-057 (PC)	on MC-4 X7

Table 5-5: Order numbers for interface cables

5.9.3 Connector Sets

Order number	Product name	Explanation
15 15 44 04-001	Connector Set MC-4 1.5-10A SM-Motor	Connector front side MC-4 compl.
15 15 44 04-002	Connector Set MC-4 22/50A SM-Motor	Connector front side MC-4 compl.
15 15 44 11-001	Connector Set MC-4 SH-Motor	Set with power plug small, short
15 15 44 11-002	Connector Set MC-4 SH-Motor	Set with power plug small, long
15 15 44 11-003	Connector Set MC-4 SH-Motor	Set with power plug large, only 2.5 mm ²

Table 5-6: Order numbers for connector sets

5.9.4 Accessories

Order number	Product name	Explanations
FI 0 78 76	FFU 3X08 K-K	mains filter 8 A
FI 0 78 77	FFU 3X30 K-K	mains filter 30 A
FI 0 78 78	FFU 3X55 K-K	mains filter 55 A
13 27 00 13	BM-4/10	bleeder module
13 13 02 57	bus clamp BT-4/DIO1	for PacNet
17 19 50 04	ME/SinCos SRS50 stand alone	master encoder
17 19 50 05	ME/SinCos SRM50 KVAF multi-turn	master encoder
17 19 10 19 - 003	Incremental master encoder DG 60 LWSR 5.000 incr / rev	master encoder for INC-4
17 19 10 19 - 006	Incremental master encoder DG 60 LWSR 10.000 incr / rev	master encoder for INC-4
ME 08600	Warning label: high voltage	105 x 52mm
20 63 00 63	OPC server	single licence
20 63 00 66 - 001	PacDrive ECAM-4	company licence

Table 5-7: Order numbers for accessories

6 Technical Data

6.1 PacDrive MC-4



NOTE

The PacDrive MC-4 supports motors with firmware up to V00.20.XX with a rotary speed up to 6000 min⁻¹.

On firmware versions V00.22.XX, the rated speed is supported up to 12000 min⁻¹.

In case of ambient temperatures >45 °C, for additional exchange of cooling air provide external fan in the switching cabinet.



NOTE

The PacDrive MC-4 is not suitable for fault current protection with a common FI safety switch with a trigger level of 30 mA. The leakage current of the unit can trigger the FI safety switch. Solutions for this problem:

- Use an FI safety switch (RCD, type B) with a trigger level of 500 mA.



NOTE

The PacDrive MC-4 / 1,5 A is adequate only when using firmware versions as from V00.22.XX, in connection with the SH Motor 055.

If a motor is used with a differing power class, the error message „138 invalid motor“ will appear.

6.1.1 In General

PacDrive MC-4 / 1.5A

	Parameter	Value
Product configuration	Product name	MC-4 / 11 / 01 / 400 V
	Order number	13 13 02 44
Power supply	- rated connection voltage	3 AC 380 V (-10%) to 480 V (+10%) - min. 3 AC 380 V (-10%) - max. 3 AC 480 V (+10%)
	- mains frequency	48 ... 62 Hz
	- control voltage/current	DC 24 V (-15% / +25%) / 1 A
DC-circuit	- DC-circuit voltage	DC 530 V to 680 V
	- capacity	165 μ F
	- U _{Bleeder} ON	DC 820 V
	- U _{Bleeder} OFF	DC 800 V
	- excess voltage	DC 860 V
	- bleeder resistance	120 Ohm
	- bleeder - permanent power - bleeder - peak power	50 W 5 kW
Motor connection	- rated power 8 kHz	1.5 A _{eff}
	- peak current 1 s	3.75 A _{eff}
	- rated power	1.1 kVA
Stray power	- electronics supply	approx. 12 W
	- bleeder (internal)	0 ... 50 W (depending on the application)
	- power part	approx. 15 W / A
I/O	Inputs	
	- inputs voltage / current	DC 20 ... 30 V / 5 mA
	- ie-input	DC 20 ... 30 V / 30 mA
	- input filter	[5 ms
	Outputs	
- relay outputs	DC 20 ... 30 V / 2 A	
Environment	Product size	see chapter Dimensions
	Box size	width: 100 mm height: 400 mm depth: 320 mm
	Product weight	3.1 kg
	Boxed weight	4.0 kg
	Ventilation	natural convection
	Ambient conditions	
	Protection class	
- casing	IP20	
- installation location	IP54, if the safety wiring is used with Inverter Enable	
- ambient temperature during operation	+5 ... +45 °C (+55 °C with reduced power)	
- for storage and transport	-2% per K at I _{NC} and I _{SC})	
- insulation	-25 ... +70 °C degree of pollution 2 ..., dewing prohibited	
- excess voltage category	K III, T2 (DIN VDE 0110)	
- excess voltage proofness	class 1 (DIN VDE 0160)	
- degree of radio distortion	class A EN 55011 / EN 61800 - 3	
rel. humidity	5% - 85% climatic category 3K3 EN 60 721	
Approval	Approvals	CE, UL, cUL

Table 6-1: Technical data of the PacDrive MC-4 / 01

PacDrive MC-4 / 3 A

	Parameter	Value
Product configuration	Product name	MC-4 / 11 / 03 / 400 V
	Order number	13 13 02 45
Power supply	- rated connection voltage	3 AC 380 V (-10%) to 480 V (+10%) - min. 3 AC 380 V (-10%) - max. 3 AC 480 V (+10%)
	- mains frequency	48 ... 62 Hz
	- control voltage/current	DC 24 V (-15% / +25%) / 1 A
DC-circuit	- DC-circuit voltage	DC 530 V to 680 V
	- capacity	165 µF
	- U _{Bleeder ON}	DC 820 V
	- U _{Bleeder OFF}	DC 800 V
	- excess voltage	DC 860 V
	- bleeder resistance	120 Ohm
	- bleeder - permanent power	50 W
	- bleeder - peak power	5 kW
Motor connection	- rated power 8 kHz	3 A _{eff}
	- peak current 1 s	7.5 A _{eff}
	- rated power	2.1 kVA
Stray power	- electronics supply	ca. 12 W
	- bleeder (internal)	0 ... 50 W (depending on the application)
	- power part	ca. 15 W / A
I/O	Inputs	
	- inputs voltage / current - ie-input - input filter	DC 20 ... 30 V / 5 mA DC 20 ... 30 V / 30 mA [5 ms]
	Outputs	
	- relay outputs	DC 20 ... 30 V / 2 A
Environment	Product size	see chapter Dimensions
	Box size	width: 100 mm height: 400 mm depth: 320 mm
	Product weight	3.1 kg
	Boxed weight	4.0 kg
	Ventilation	natural convection
	Ambient conditions	
	Protection class	
- casing	IP20	
- installation location	IP54, if the safety wiring is used with Inverter Enable	
- ambient temperature during operation	+5 ... +45 °C (+55 °C with reduced power)	
- for storage and transport	-2% per K at I _{NC} and I _{SC})	
-insulation	-25 ... +70 °C	
- excess voltage category	degree of pollution 2 ..., dewing prohibited	
- excess voltage proofness	K III, T2 (DIN VDE 0110)	
- degree of radio distortion	class 1 (DIN VDE 0160)	
rel. humidity	class A EN 55011 / EN 61800 - 3	
	5% - 85% climatic category 3K3 EN 60 721	
Approval	Approvals	CE, UL, cUL

Table 6-2: Technical data of the PacDrive MC-4 / 03

PacDrive MC-4 / 5 A



CAUTION!

Unit has different rated connection voltage! Wrong connection voltage may destroy the MotorController! During wiring and installation, make sure that the connection voltage matches the MotorController.

	Parameter	Value
Product configuration	Product name	MC-4 / 11 / 05 / 230 V
	Order number	13 13 02 46
Power supply	- rated connection voltage	3 AC / 1 AC 220 V (-10%) to 240 V (+10%)
	- mains frequency	48 ... 62 Hz
	- control voltage/current	DC 24 V (-15% / +25%) / 1 A
DC-circuit	- DC-circuit voltage	DC 260 V to 370 V
	- capacity	660 µF
	- U _{Bleeder ON}	DC 410 V
	- U _{Bleeder OFF}	DC 400 V
	- excess voltage	DC 430 V
	- bleeder resistance	33 Ohm
	- bleeder - permanent power	50 W
	- bleeder - peak power	5 kW
Motor connection	- rated power 8 kHz	5 A _{eff}
	- peak current 1 s	12.5 A _{eff}
	- rated power	1.9 kVA
Stray power	- electronics supply	ca. 12 W
	- bleeder (internal)	0 ... 50 W (depending on the application)
	- power part	ca. 15 W / A
I/O	Inputs	
	- inputs voltage / current	DC 20 ... 30 V / 5 mA
	- ie-input	DC 20 ... 30 V / 30 mA
	- input filter	[5 ms
	Outputs	
	- relay outputs	DC 20 ... 30 V / 2 A
Environment	Product size	see chapter Dimensions
	Box size	width: 100 mm height: 400 mm depth: 320 mm
	Product weight	3.1 kg
	Boxed weight	4.0 kg
	Ventilation	natural convection
	Ambient conditions	
	Protection class	
	- casing	IP20
	- installation location	IP54, if the safety wiring is used with Inverter Enable
	- ambient temperature during operation	+5 ... +45 °C (+55 °C with reduced power)
- for storage and transport	-2% per K at I _{NC} and I _{SC})	
-insulation	-25 ... +70 °C degree of pollution 2 ..., dewing prohibited	
	- excess voltage category	K III, T2 (DIN VDE 0110)
	- excess voltage proofness	class 1 (DIN VDE 0160)
	- degree of radio distortion	class A EN 55011 / EN 61800 - 3
	rel. humidity	5% - 85% climatic category 3K3 EN 60 721
Approval	Approvals	CE, UL, cUL

Table 6-3: Technical data of the PacDrive MC-4 / 05

PacDrive MC-4 / 10 A

	Parameter	Value
Product configuration	Product name	MC-4 / 11 / 10 / 400 V
	Order number	13 13 02 47
Power supply	- rated connection voltage	3 AC 380 V (-10%) to 480 V (+10%)
	- mains frequency	48 ... 62 Hz
	- control voltage/current	DC 24 V (-15% / +25%) / 1 A
DC-circuit	- DC-circuit voltage	DC 530 V to 680 V
	- capacity	330 µF
	- U _{Bleeder ON}	DC 820 V
	- U _{Bleeder OFF}	DC 800 V
	- excess voltage	DC 860 V
	- bleeder resistance	60 Ohm
	- bleeder - permanent power	100 W
	- bleeder - peak power	10 kW
Motor connection	- rated power 8 kHz	10 A _{eff}
	- peak current 1 s	25 A _{eff}
	- rated power	6.9 kVA
Stray power	- electronics supply	ca. 12 W
	- bleeder (internal)	0 ... 100 W (depending on the application)
	- power part	ca. 15 W / A
I/O	Inputs	
	- inputs voltage / current - ie-input - input filter	DC 20 ... 30 V / 5 mA DC 20 ... 30 V / 30 mA [5 ms]
	Outputs	
	- relay outputs	DC 20 ... 30 V / 2 A
Environment	Product size	see chapter Dimensions
	Box size	width: 100 mm height: 400 mm depth: 320 mm
	Product weight	3.6 kg
	Boxed weight	4.5 kg
	Ventilation	natural convection (temperature controlled)
	Ambient conditions	
Protection class		
- casing	IP20	
- installation location	IP54, if the safety wiring is used with Inverter Enable	
- ambient temperature during operation	+5 ... +45 °C (+55 °C with reduced power)	
- for storage and transport	-2% per K at I _{NC} and I _{SC})	
- insulation	-25 ... +70 °C	
	degree of pollution 2 ..., dewing prohibited	
- excess voltage category	K III, T2 (DIN VDE 0110)	
- excess voltage proofness	class 1 (DIN VDE 0160)	
- degree of radio distortion	class A EN 55011 / EN 61800 - 3	
rel. humidity	5% - 85% climatic category 3K3 EN 60 721	
Approval	Approvals	CE, UL, cUL

Table 6-4: Technical data of the PacDrive MC-4 / 10

PacDrive MC-4 / 22 A

	Parameter	Value
Product configuration	Product name	MC-4 / 11 / 22 / 400 V
	Order number	13 13 02 54
Power supply	- rated connection voltage	3 AC / 1 AC 380 V (-10%) to 480 V (+10%)
	- mains frequency	48 ... 62 Hz
	- control voltage/current	DC 24 V (-15% / +25%) / 1 A
DC-circuit	- DC-circuit voltage	DC 530 V to 680 V
	- capacity	705 µF
	- U _{Bleeder ON}	DC 820 V
	- U _{Bleeder OFF}	DC 800 V
	- excess voltage	DC 860 V
	- bleeder resistance	42 Ohm
	- bleeder - permanent power	150 W
	- bleeder - peak power	15 kW
Motor connection	- rated power 8 kHz	22 A _{eff}
	- peak current 1 s	55 A _{eff}
	- rated power	15.2 kVA
Stray power	- electronics supply	ca. 12 W
	- bleeder (internal)	0 ... 150 W (depending on the application)
	- power part	ca. 15 W / A
I/O	Inputs	
	- inputs voltage / current - ie-input - input filter	DC 20 ... 30 V / 5 mA DC 20 ... 30 V / 30 mA [5 ms]
	Outputs	
	- relay outputs	DC 20 ... 30 V / 2 A
Environment	Product size	see chapter Dimensions
	Box size	width: 160 mm height: 400 mm depth: 310 mm
	Product weight	6.3 kg
	Boxed weight	7.0 kg
	Ventilation	natural convection (temperature controlled)
Approval	Ambient conditions	
	Protection class	
	- casing	IP20
	- installation location	IP54, if the safety wiring is used with Inverter Enable
	- ambient temperature during operation	+5 ... +45 °C (+55 °C with reduced power)
	- for storage and transport	-2% per K at I _{NC} and I _{SC})
	-insulation	-25 ... +70 °C degree of pollution 2 ..., dewing prohibited
- excess voltage category	K III, T2 (DIN VDE 0110)	
- excess voltage proofness	class 1 (DIN VDE 0160)	
- degree of radio distortion	class A EN 55011 / EN 61800 - 3	
rel. humidity	5% - 85% climatic category 3K3 EN 60 721	
Approvals	CE, UL, cUL	

Table 6-5: Technical data of the PacDrive MC-4 / 22

PacDrive MC-4 / 50 A

	Parameter	Value
Product configuration	Product name	MC-4 / 11 / 50 / 400 V
	Order number	13 13 02 56
Power supply	- rated connection voltage	3 AC / 1 AC 380 V (-10%) to 480 V (+10%)
	- mains frequency	48 ... 62 Hz
	- control voltage/current	DC 24 V (-15% / +25%) / max. 3 A
DC-circuit	- DC-circuit voltage	DC 530 V to 680 V
	- capacity	1400 µF
	- U _{Bleeder ON}	DC 820 V
	- U _{Bleeder OFF}	DC 800 V
	- excess voltage	DC 860 V
	- bleeder resistance	18 Ohm
	- bleeder - permanent power	approx. 600 W at 45 °C ambient temp.
	- bleeder - peak power	35 kW
Motor connection	- rated power 8 kHz	50 A _{eff}
	- peak current 1 s	125 A _{eff}
	- rated power	34.6 kVA
Stray power	- electronics supply	ca. 55 W
	- bleeder (internal)	0 ... 600 W (depending on the application)
	- power part	ca. 15 W / A
I/O	Inputs	
	- inputs voltage / current	DC 20 ... 30 V / 5 mA
	- ie-input	DC 20 ... 30 V / 30 mA
	- input filter	[5 ms]
	Outputs	
	- relay outputs	DC 20 ... 30 V / 2 A
Environment	Product size	see chapter Dimensions
	Box size	width: 350 mm height: 450 mm depth: 310 mm
	Product weight	16.5 kg
	Boxed weight	19.0 kg
	Ventilation	natural convection (temperature controlled)
	Ambient conditions	
	Protection class	
- casing	IP20	
- installation location	IP54, if the safety wiring is used with Inverter Enable	
- ambient temperature during operation	+5 ... +45 °C (+55 °C with reduced power)	
- for storage and transport	-2% per K at I _{NC} and I _{SC})	
- insulation	-25 ... +70 °C	
	degree of pollution 2 ..., dewing prohibited	
- excess voltage category	K III, T2 (DIN VDE 0110)	
- excess voltage proofness	class 1 (DIN VDE 0160)	
- degree of radio distortion	class A EN 55011 / EN 61800 - 3 with external mains filter	
rel. humidity	5% - 85% climatic category 3K3 EN 60 721	
Approval	Approvals	CE, UL, cUL (in preparation)

Table 6-6: Technical data of the PacDrive MC-4 / 50



CAUTION!

Firmware version V00.11.XX or higher is required to operate the PacDrive MC-4 / 50 A! Some functions (including safety-relevant functions) are not supported in firmware versions older than V00.11.XX.

- Only use the PacDrive MC-4 / 50A with firmware in original condition.
 - If a firmware change is inevitable, only use versions higher than V00.11.XX.
-



NOTE

The „ambient temperature during operation“ up to 45 °C is only valid if the control voltage is at least DC 24 V, so that the fans can work with the required power.



NOTE

To observe EMT requirements, it is necessary to use an external mains filter (order number FI07878).

6.1.2 Interface

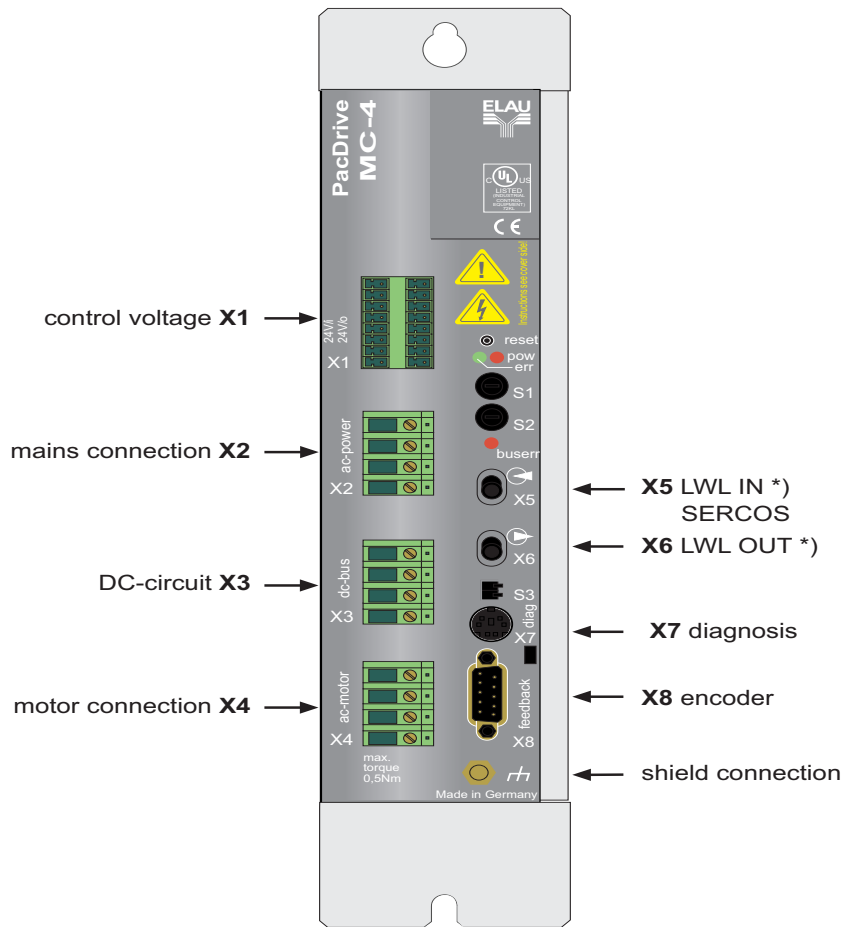

PDM_Anschlussübersicht_MC-4_us9912.FH8

Fig. 6-1: Overview of connections of the PacDrive MC-4

6.1.3 Electrical Connections

X1 - control voltage (MC-4 1.5 A to 10 A)

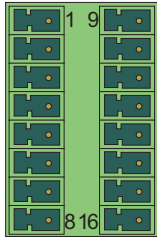

Pin	Designation	Meaning	Range	Max. cross section
1	24 V	supply voltage	-15% / +25%	1.5 mm ²
2	0 V	supply voltage		1.5 mm ²
3	iei	inverter enable		1.5 mm ²
4	en	enable	DC 24V (acc. IEC61131-2 Typ I)	1.5 mm ²
5	ϑ (5)	PTC motor temp.		1.5 mm ²
6	ϑ (6)	PTC motor temp.		1.5 mm ²
7	bi+	power supply holding brake	DC +24V	1.5 mm ²
8	bi-	power supply holding brake	DC 0V	1.5 mm ²
9	24 V	bridged with Pin 1		1.5 mm ²
10	0 V	bridged with Pin 2		1.5 mm ²
11	ieo	inverter enable output		1.5 mm ²
12	ieo	inverter enable output		1.5 mm ²
13	rdy	ready contact (opens in case of error)	DC 20...30V / 2A	1.5 mm ²
14	rdy	ready contact	DC 20...30V / 2A	1.5 mm ²
15	bo+ (8)	connection holding brake	DC +24V	1.5 mm ²
16	bo- (7)	connection holding brake	0V	1.5 mm ²

Table 6-7: Electrical connections of the MC-4 (1.5 ... 10 A) / X1

NOTE

The permissible permanent current of the plug-in terminal „X1 control voltage“ (MC-4 1.5 A to 10 A) is 8 A.
The maximum number of MCs connected parallel via the plug-in terminal X 1 must be no greater than six.

X2 - mains connection (MC-4 1.5 A to 10 A)

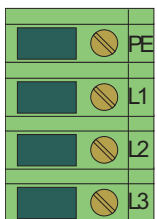

Pin	Designation	Meaning	Range	Max. cross section
1	PE	earth conductor connection		2.5 mm ²
2	L1	phase L1	3 AC 380 - 480 V	2.5 mm ²
3	L2	phase L2	3 AC 380 - 480 V	2.5 mm ²
4	L3	phase L3	3 AC 380 - 480 V	2.5 mm ²

Table 6-8: Electrical connections of the MC-4 (1.5 ... 10 A) / X2



NOTE

The permissible permanent current of the plug-in terminal „X2 mains connection“ (MC-4 1.5 A to 10 A) is 24 A.



NOTE

The range for the MC-4 / 5 A is 220 - 240 V with 3-phase or 1-phase feed. With 1-phase feed, connect L to L1 and N to L2. Leave L3 free.



CAUTION!

No safe contact!

Cables and clamps may be damaged!

- For cables with a cross section of 2.5 mm², use end sleeves without plastic collar and a length of at least 12 mm or end sleeves with plastic collar and a metal sleeve that is at least 12 mm long.

X3 - DC-circuit (MC-4 1.5 A to 10 A)

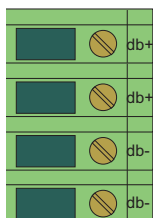

Pin	Designation	Meaning	Range	Max. cross section
1	db +	DC-circuit voltage +	DC 0 - 860 V	2.5 mm ²
2	db +	DC-circuit voltage +	DC 0 - 860 V	2.5 mm ²
3	db -	DC-circuit voltage -	DC 0 - 860 V	2.5 mm ²
4	db -	DC-circuit voltage -	DC 0 - 860 V	2.5 mm ²

Table 6-9: Electrical connections of the MC-4 (1.5 ... 10 A) / X3



NOTE

The permissible permanent current of the plug-in terminal „X3 Dc-circuit“ (MC-4 1.5 A to 10 A) is 24 A.



CAUTION!

No safe contact!

Cables and clamps may be damaged!

- For cables with a cross section of 2.5 mm², use end sleeves without plastic collar and a length of at least 12 mm or end sleeves with plastic collar and a metal sleeve that is at least 12 mm long.

X4 - motor connection (MC-4 1.5 A to 10 A)

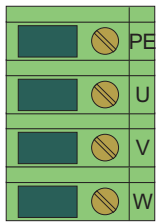

Pin	Designation	Meaning	Range	Max. cross section
1	PE	earth conductor connection		2.5 mm ²
2	U	phase U	3 AC 0 - 480 V	2.5 mm ²
3	V	phase V	3 AC 0 - 480 V	2.5 mm ²
4	W	phase W	3 AC 0 - 480 V	2.5 mm ²

Table 6-10: Electrical connections of the MC-4 (1.5 ... 10 A) / X4



NOTE

The permissible permanent current of the plug-in terminal „X4 motor connection (MC-4 1.5 A to 10 A) is 24 A.



CAUTION!

No safe contact!

Cables and clamps may be damaged!

- For cables with a cross section of 2.5 mm², use end sleeves without plastic collar and a length of at least 12 mm or end sleeves with plastic collar and a metal sleeve that is at least 12 mm long.

X1 - control voltage (MC-4 22 A, 50 A)

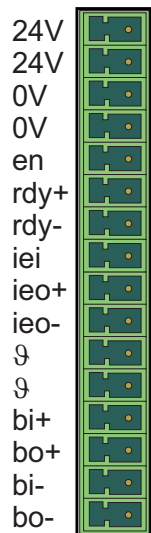

Pin	Designation	Meaning	Range	Max. cross section
1	24 V	supply voltage	-15% / +25%	1.5 mm ²
2	24 V	bridged with pin 1		1.5 mm ²
3	0 V	supply voltage		1.5 mm ²
4	0 V	bridged with Pin 3		1.5 mm ²
5	en	enable	DC 24V (acc. IEC61131-2 Typ I)	1.5 mm ²
6	rdy+	ready contact	DC 20...30V / 2A	1.5 mm ²
7	rdy-	ready contact (opens in case of error)	DC 20...30V / 2A	1.5 mm ²
8	iei	inverter enable		1.5 mm ²
9	ieo+	inverter enable output		1.5 mm ²
10	ieo-	inverter enable output		1.5 mm ²
11	(5)	PTC motor temp.		1.5 mm ²
12	(6)	PTC motor temp.		1.5 mm ²
13	bi+	power supply holding brake	DC +24V	1.5 mm ²
14	bo+ (8)	connection holding brake	DC +24V	1.5 mm ²
15	bi-	power supply holding brake	DC 0V	1.5 mm ²
16	bo- (7)	connection holding brake	0V	1.5 mm ²

Table 6-11: Electrical connections of the MC-4 (22 A, 50 A) / X1

X2 - mains connection (MC-4 22 A)

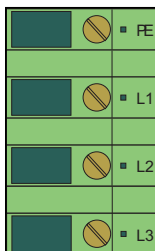

Pin	Designation	Meaning	Range	Max. cross section
1	PE	earth conductor connection		4 mm ²
2	L1	phase L1	3 AC 380 - 480V	4 mm ²
3	L2	phase L2	3 AC 380 - 480V	4 mm ²
4	L3	phase L3	3 AC 380 - 480V	4 mm ²

Table 6-12: Electrical connections of the MC-4 (22 A) / X2

X3 - DC-circuit (MC-4 22 A)

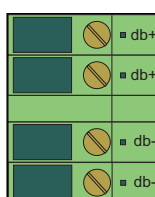

Pin	Designation	Meaning	Range	Max. cross section
1	db +	DC-circuit voltage +	DC 0 - 860 V	4 mm ²
2	db +	DC-circuit voltage +	DC 0 - 860 V	4 mm ²
3	db -	DC-circuit voltage -	DC 0 - 860 V	4 mm ²
4	db -	DC-circuit voltage -	DC 0 - 860 V	4 mm ²

Table 6-13: Electrical connections of the MC-4 (22 A) / X3

X4 - motor connection (MC-4 22 A)

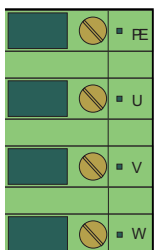

Pin	Designation	Meaning	Range	Max. cross section
1	PE	earth conductor connection		4 mm ²
2	U (1)	phase U	3 AC 0 - 480V	4 mm ²
3	V (2)	phase V	3 AC 0 - 480V	4 mm ²
4	W (3)	phase W	3 AC 0 - 480V	4 mm ²

Table 6-14: Electrical connections of the MC-4 (22 A) / X4

X2 - mains connection (MC-4 50 A)

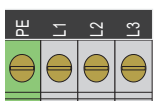

Pin	Designation	Meaning	Range	Max. cross section
1	PE	earth conductor connection		16 mm ²
2	L1	phase L1	3 AC 380 - 480V	16 mm ²
3	L2	phase L2	3 AC 380 - 480V	16 mm ²
4	L3	phase L3	3 AC 380 - 480V	16 mm ²

Table 6-15: Electrical connections of the MC-4 (50 A) / X2

X3 - DC-circuit (MC-4 50 A)

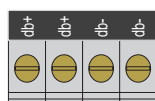

Pin	Designation	Meaning	Range	Max. cross section
1	db +	DC-circuit voltage +	DC 0 - 860 V	16 mm ²
2	db +	DC-circuit voltage +	DC 0 - 860 V	16 mm ²
3	db -	DC-circuit voltage -	DC 0 - 860 V	16 mm ²
4	db -	DC-circuit voltage -	DC 0 - 860 V	16 mm ²

Table 6-16: Electrical connections of the MC-4 (50 A) / X3

X4 - motor connection (MC-4 50 A)

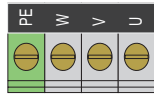

Pin	Designation	Meaning	Range	Max. cross section
1	PE	earth conductor connection		16 mm ²
2	W (3)	phase W	3 AC 0 - 480V	16 mm ²
3	V (2)	phase V	3 AC 0 - 480V	16 mm ²
4	U (1)	phase U	3 AC 0 - 480V	16 mm ²

Table 6-17: Electrical connections of the MC-4 (50 A) / X4

X7 - diagnosis

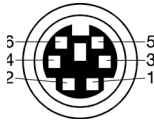

Pin	Designation	Meaning	Range	Max. cross section
1	PRO_SEL			0.25 mm ²
2	RxD	Receive Data		0.25 mm ²
3	TxD	Transmit Data		0.25 mm ²
4	GND	Signal Ground		0.25 mm ²
5	RS232_SEL			0.25 mm ²
6	VCC			0.25 mm ²

Table 6-18: Electrical connections of the MC-4 / X7

X8 - motor encoder (SinCos)

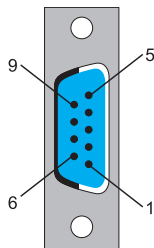

Pin	Designation	Meaning	Range	Max. cross section
1	REFSIN	sinus reference signal		0.25 mm ²
2	SIN	sinus trace		0.25 mm ²
3	REFCOS	cosine reference signal		0.25 mm ²
4	COS	cosine trace		0.25 mm ²
5	+12V	supply voltage		0.25 mm ²
6	RS485	parameter channel -		0.25 mm ²
7	RS485	parameter channel +		0.25 mm ²
8	SC_SEL	encoder connected (bridge to GND)		0.25 mm ²
9	GND	supply voltage		0.25 mm ²

Table 6-19: Electrical connections of the MC-4 / X8



CAUTION!

Disconnection of SinCos encoder plug while unit is powered on! SinCos encoder may be damaged!

- Disconnect and connect the SinCos encoder plug only in voltage-free state (disconnect PacDrive MC-4 from 24 V power supply!).

6.1.4 Dimensions

PacDrive MC-4 / 1.5 A and 3 A

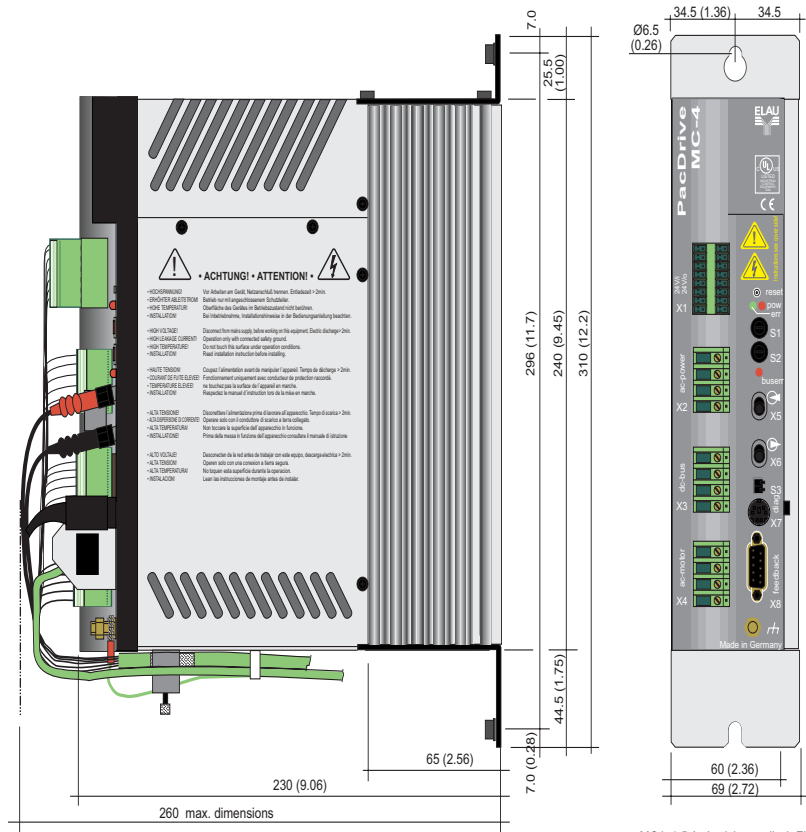

MC4_1.5_A_Ansicht_englisch.FH8

Fig. 6-2: Dimensions of the PacDrive MC-4 / 1.5 A and 3 A

PacDrive MC-4 / 5 A (230 V)

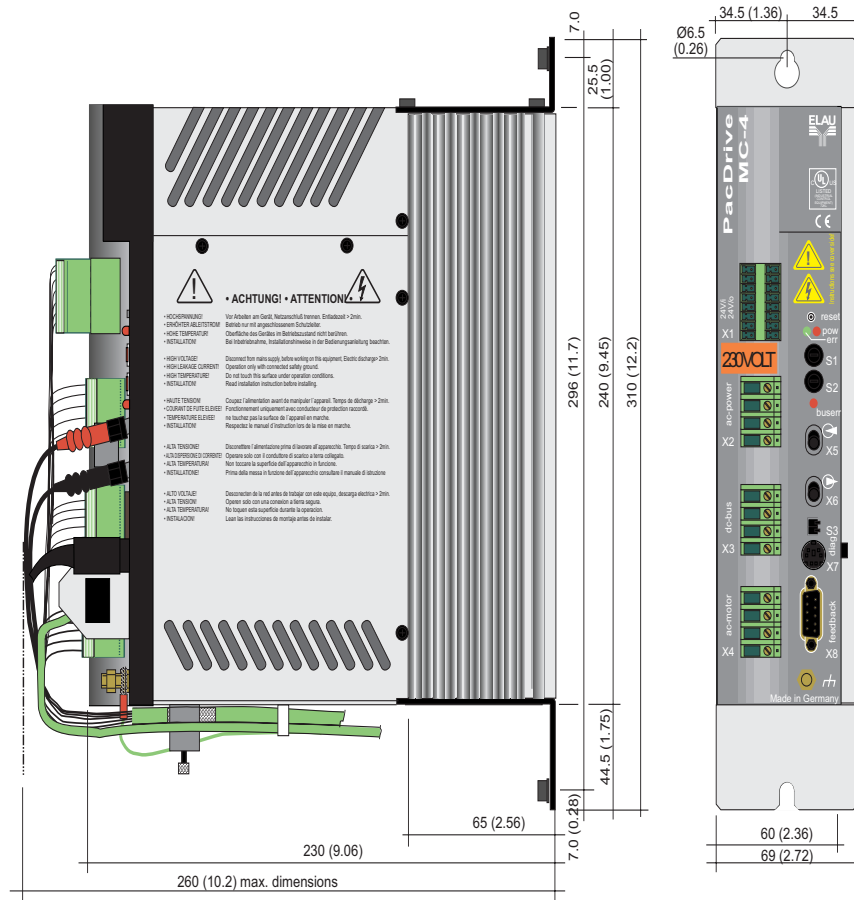

MC4_5A_Ansicht_englisch.FH8

Fig. 6-3: Dimensions of the PacDrive MC-4 / 5 A

PacDrive MC-4 / 10 A

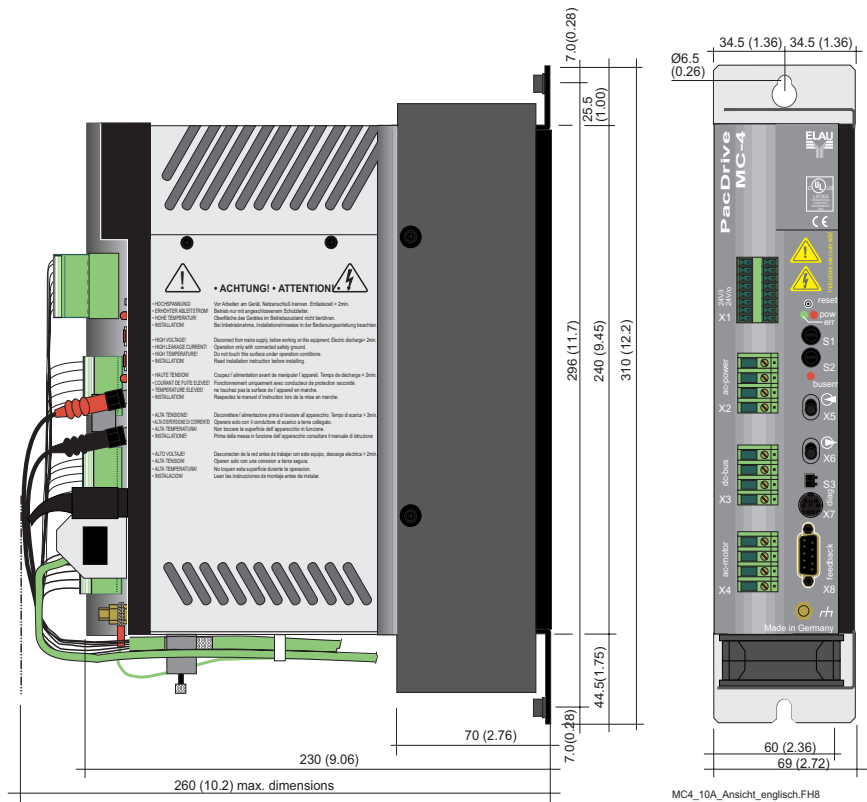

MC4_10A_Ansicht_englisch.FH8

Fig. 6-4: Dimensions of the PacDrive MC-4 / 10 A

PacDrive MC-4 / 22 A

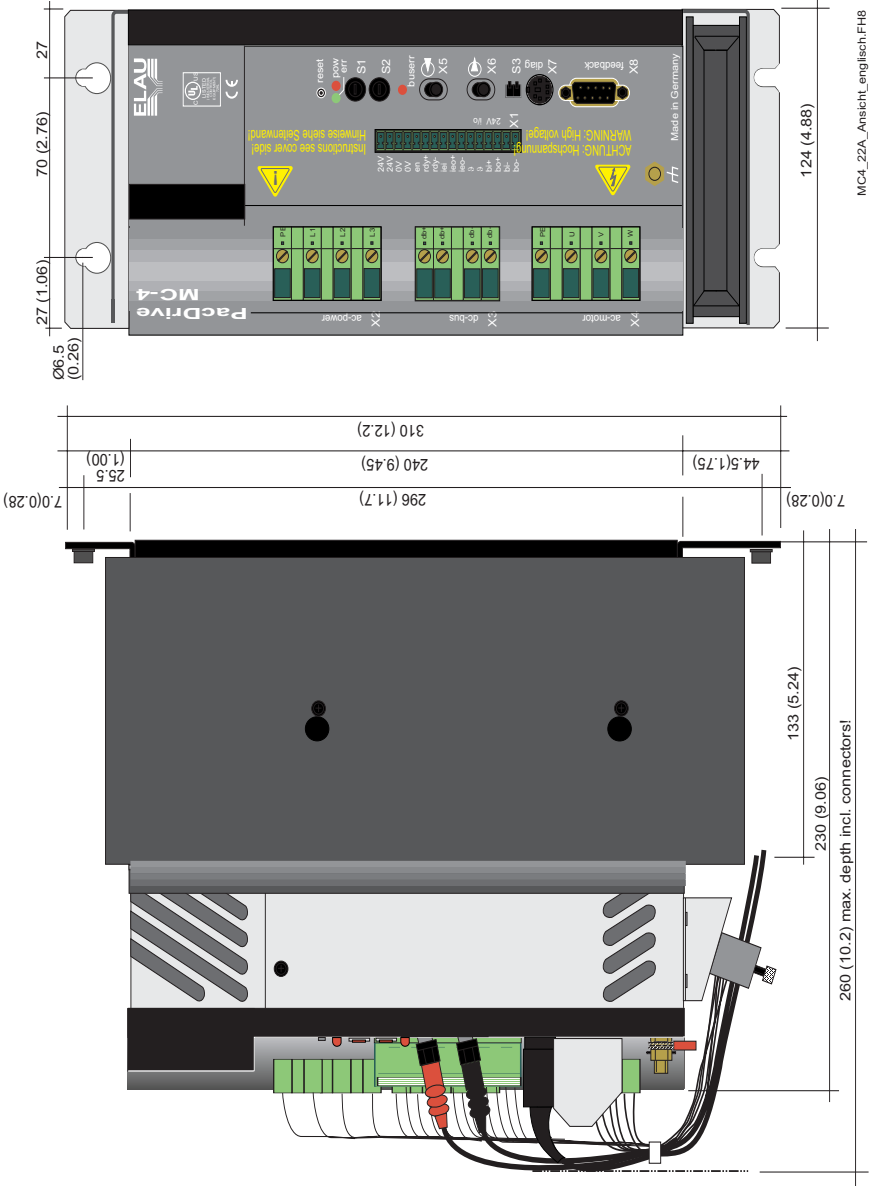

MC4_22A_Ansicht_englisch.FH8

Fig. 6-5: Dimensions of the MC-4 / 22 A

PacDrive MC-4 / 50 A

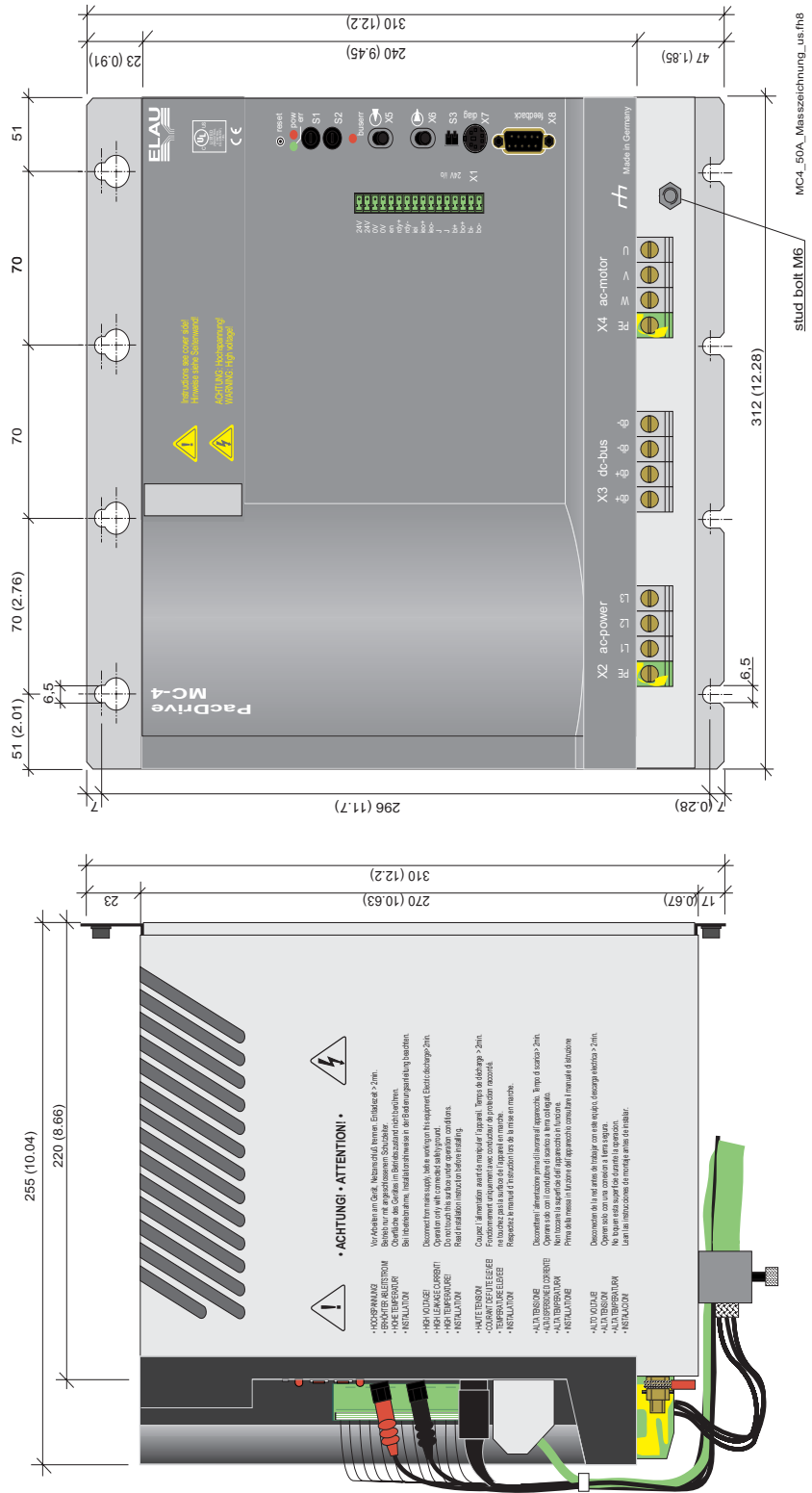

Fig. 6-6: Dimensions of the MC-4 / 50 A

PDM_OpMeMC-4_06_us.FM

6.2 PacDrive BM-4

6.2.1 In General

	Parameter	Value
Product configuration	Product name	BM-4 bleeder module
	Order number	13 27 00 13
Power supply	Supply voltage	DC 24 V (-15 / +25 %), 0.5 A
Bleeder limits	- U _{Bleeder} ON	DC 790 ... 820 V in 10V steps
	- U _{Bleeder} OFF	20 V below U _{Bleeder} ON
Power details	Resistance	18 Ohm
	Permanent power	800 W
	Peak power	45 kW
I/O	Outputs - relay outputs	DC 20 ... 30 V / 2 A
Environment	Product size	see chapter Dimensions
	Box size	width: 100 mm height: 400 mm depth: 320 mm
	Product weight	2.5 kg
Approval	Admissible ambient temperature - during operation	0 ... +55 °C
	- for storage and transport	-20 °C ... +80 °C
	Approvals	CE, UL, cUL

Table 6-20: Technical data of the PacDrive BM-4 bleeder module

6.2.2 Display and operating units

reset



Button to reset the PacDrive BM-4. Only the bleeder module is rebooted when you press the „reset“ button. Other PacDrive components have their own „reset“ buttons.

pow



The „pow“ LED indicates the state of the control voltage.

OFF	control voltage (24 V) missing or too low.
ON	normal operation; control voltage in normal range

err (error indicator)



The error LED (err) indicates errors. The table below lists possible states of the error LED with corresponding error descriptions.

OFF	normal operation
Flashing slowly (on:500ms / off: 2000ms)	bleeder I ² t at the limit
Flashing fast (an:500ms / aus:500ms)	-DC-circuit voltage too high - supply voltage too low - temperature too high (no reset necessary; the device is ready-to-operate again after cooling down)
ON	bleeder error

bla (bleeder active)



When the PacDrive BM-4 is in a active condition, the display shines „bla“.

6.2.3 Interface

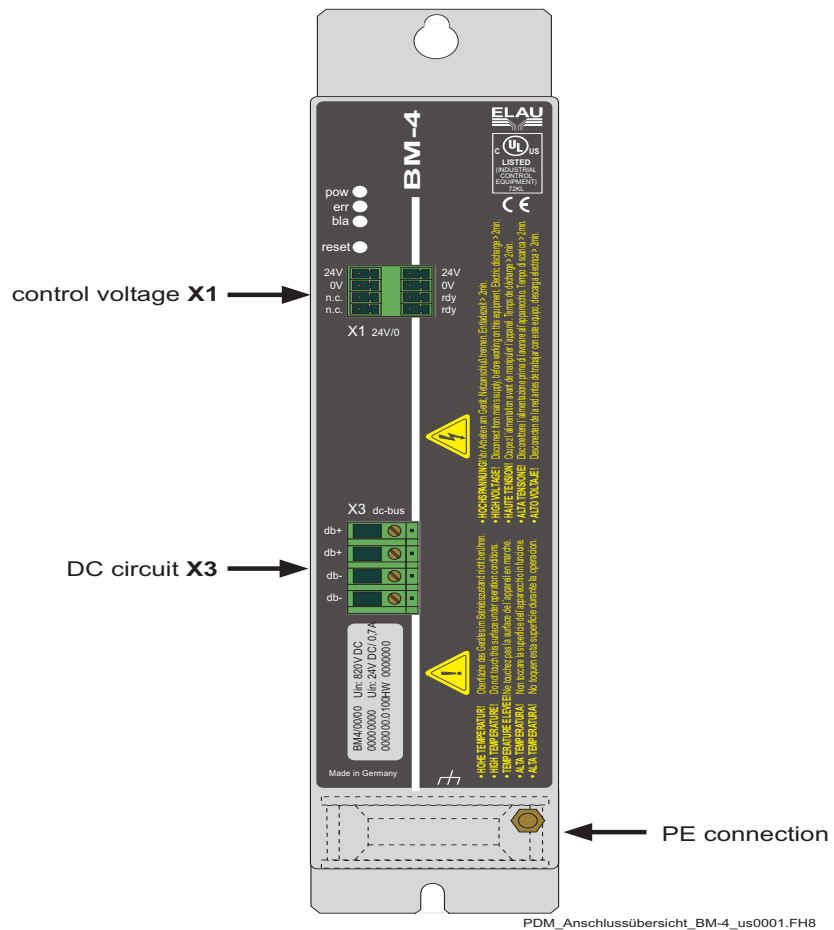
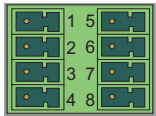

Fig. 6-7: Overview of connections of the BM-4 bleeder module

6.2.4 Electrical Connections

X1 - power supply / watchdog



Pin	Designation	Meaning	Range	Max. cross section
1	DC +24V	supply voltage	-15% / +25%	1.5 mm ²
2	DC 0V	supply voltage		1.5 mm ²
3		reserved		1.5 mm ²
4		reserved		1.5 mm ²
5	DC +24V	supply voltage	-15% / +25%	1.5 mm ²
6	DC 0V	supply voltage		1.5 mm ²
7	rdy	ready		1.5 mm ²
8	rdy	ready		1.5 mm ²

Table 6-21: Electrical connections of the BM-4 / X1

X2 - DC-circuit

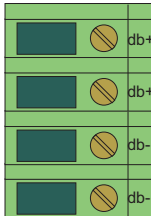

Pin	Designation	Meaning	Range	Max. cross section
1	db +	DC-circuit voltage +	DC 530 - 860 V	2.5 mm ²
2	db +	DC-circuit voltage +	DC 530 - 860 V	2.5 mm ²
3	db -	DC-circuit voltage -	DC 530 - 860 V	2.5 mm ²
4	db -	DC-circuit voltage -	DC 530 - 860 V	2.5 mm ²

Table 6-22: Electrical connections of the BM-4 / X2



CAUTION!

No safe contact!

Cable and clamp may be damaged!

- For cables with a cross section of 2.5 mm², use end sleeves without plastic collar and a length of at least 12 mm or end sleeves with plastic collar and a metal sleeve that is at least 12 mm long.

6.2.5 Dimensions

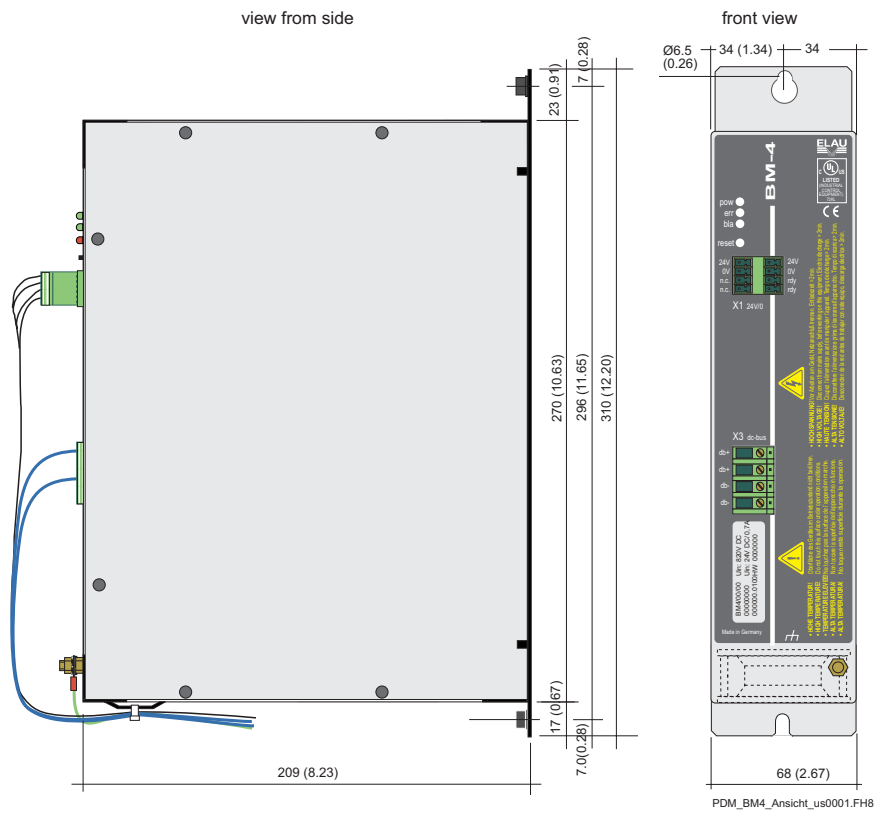

Fig. 6-8: Dimensions of the BM-4 bleeder module

6.3 PacDrive Mains Filter

6.3.1 In General

Following are the mains filters for all service types of the PacDrive system. The characteristics the mains filters stand for are:

- high symmetrical and asymmetrical damping
- rated voltage 3 AC 480 V
- compact design
- touch-proof clamps
- in accordance with UL 1283

Parameter	Value
mechanical design	aluminium housing
rated voltage	3 AC 480 V
operating frequency	50 / 60 Hz
leakage current (bei 50 Hz)	< 35 mA (3 phases) 100 mA (max.)
temperature range	-25 ... +50 °C
connection	L1 / L2 / L3: touch proof screw terminal PE-connection: bolt M5 / M6 / M8
protection class	IP 20

Table 6-23: Technical data of the mains filter in general

Mains filter 3X08 K-K

Parameter	Value
product name	mains filter FFU 3X08 K-K
order number	FI07876
rated power	8 A
power loss	4 W
connection cross-section	4 mm ²
weight	0.6 kg

Table 6-24: Technical data of the mains filter FFU 3X08 K-K

Mains filter FFU 3X30 K-K

Parameter	Value
product name	mains filter FFU 3X30 K-K
order number	FI07877
rated power	30 A
power loss	12 W
connection cross-section	10 mm ²
weight	1.3 kg

Table 6-25: Technical data of the mains filter FFU 3X30 K-K

Mains filter FFU 3X55 K-K

Parameter	Value
product name	mains filter FFU 3X55 K-K
order number	FI07878
rated power	55 A
power loss	18 W
connection cross-section	16 mm ²
weight	1.9 kg

Table 6-26: Technical data of the mains filter FFU 3X55 K-K



NOTE

If you need mains filters with higher rated currents, please contact our application department.

6.3.2 Electrical Connections

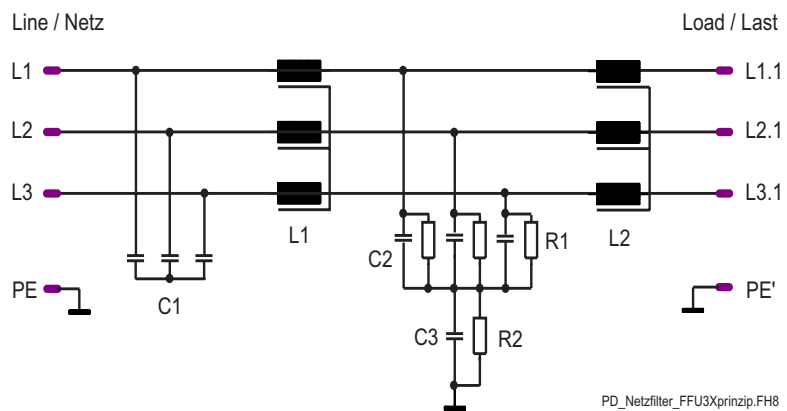

Fig. 6-9: Principle circuit diagram of the mains filter FFU 3X.. K-K

6.3.3 Electrical Connections

FI 07876 / 8A

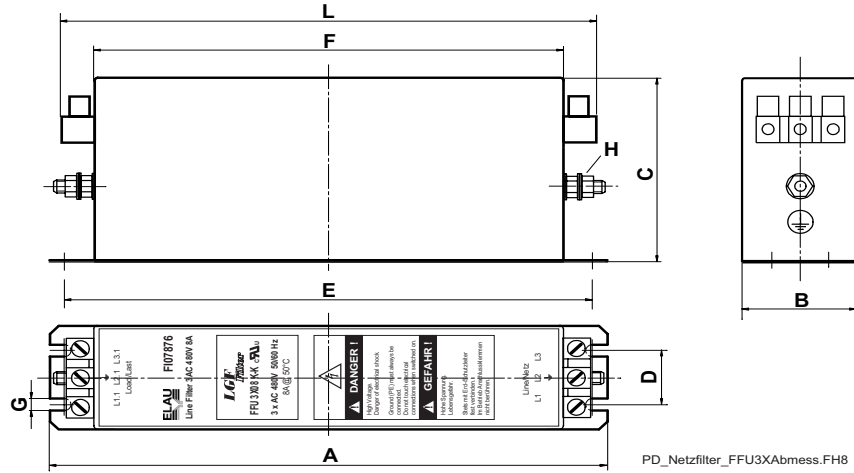

Fig. 6-10: Dimensional drawing of the mains filters

product name (order no.)	A [mm]	B [mm]	C [mm]	D [mm]	E [mm]	F [mm]	G [mm]	H	L [mm]
FFU 3X08 K-K (FI07876)	190	40	70	20	180	160	5,4	M5	185
FFU 3X30 K-K (FI07877)	270	50	85	30	255	240	5,4	M5	265
FFU 3X55 K-K (FI07878)	250	85	90	60	235	220	5,4	M6	258

Table 6-27: Dimensions of the mains filters

6.4 PacDrive Mains Choke

6.4.1 Application of mains choke

The use of PacDrive systems requires protection measures in the network supply of the PacDrive servo drives. For each mains contactor group, the insertion of a separate choke is necessary.

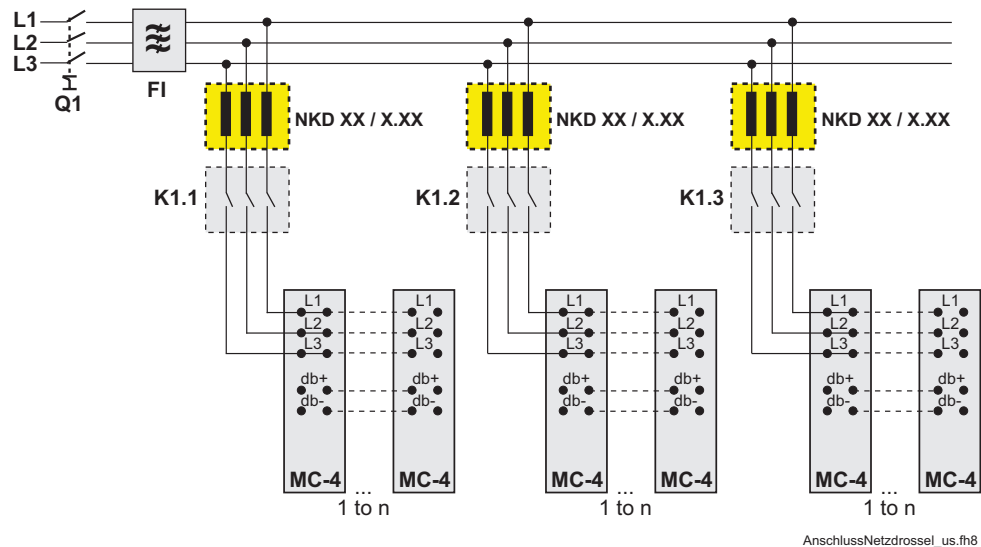

Fig. 6-11: Schematic diagram for the use of the mains chokes

For a failure-free operation, you have to have the correct dimensioning of the mains choke. The dimensioning is based upon the effective power of the respective mains contactor group.

There are three different construction sizes available:

Continuous current	ELAU Article number	Description
10A	FI07880	NKD 10 / 2.93
25A	FI07874	NKD 25 / 1.17
50A	FI07875	NKD 50 / 0.59

Table 6-28: Article number of the mains chokes

You can purchase the mains chokes directly by ELAU, stating the above mentioned Article numbers.

6.4.2 Dimensions

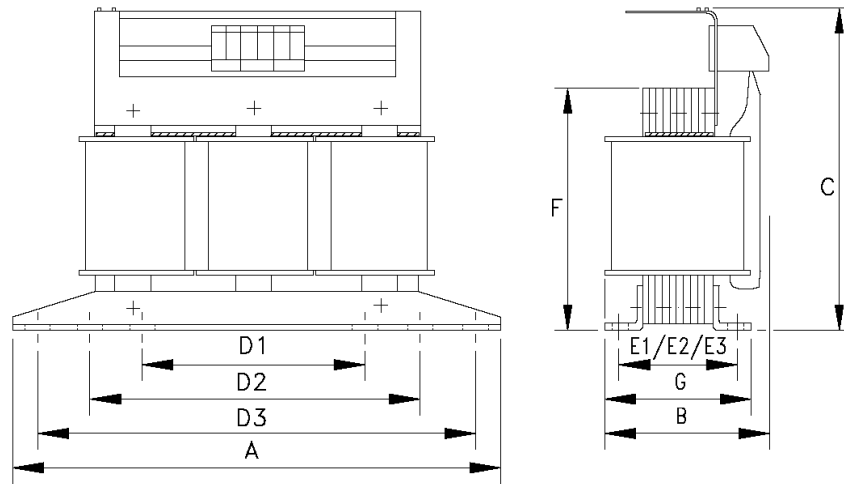

Fig. 6-12: Figure 2: 10A and 25A mains chokes NKD 10 / 2.93 and NKD 25 / 1.17

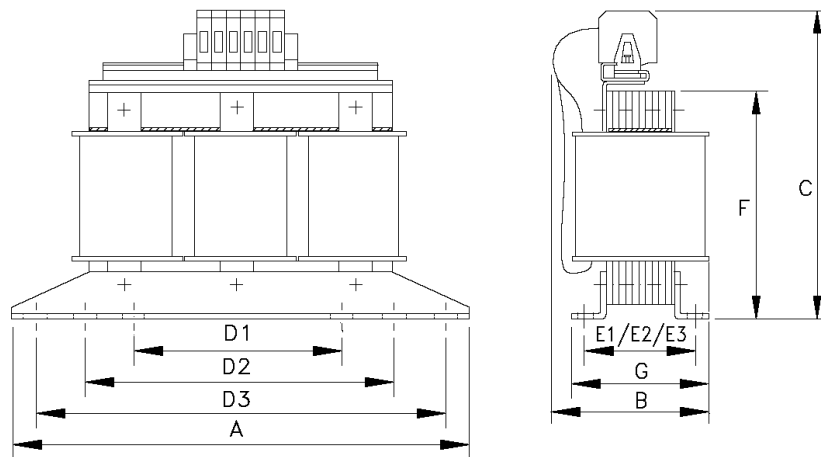

Fig. 6-13: Figure 3: 50A mains choke NKD 50 / 0.59

Mains choke	A	B	C	D1	D2	D3	E1	E2	E3	F	G
NKD 10 / 2.93	148	76	151	90	100	136	39	45	49	110	69
NKD 25 / 1.17	178	106	175	113	130	166	64,5	71,5	69,5	133	89,5
NKD 50 / 0.59	267	115	265	176	180	249	71	98	79	200	115

Table 6-29: Dimensions of the mains chokes in [mm]

10 Appendix

10.1 Contact Addresses

For repair

Please send the components to be repaired or checked along with the error report, to this address:

ELAU AG

Abt. Kundendienst house address:
Postfach 1255 Dillberg 12
97821 Marktheidenfeld 97828 Marktheidenfeld
Phone: +49 (0) 93 91 / 606-142
Fax: +49 (0) 93 91 / 606-340

Service team

Should you need to talk to a member of our service team or require on-site service, please contact:

ELAU AG

Dillberg 12
D-97828 Marktheidenfeld
Phone: +49 (0) 9391 / 606 - 0
Fax: +49 (0) 9391 / 606 - 300
e-mail: info@elau.de
Internet: www.elau.de

ELAU, Inc.

165 E. Commerce Drive
Schaumburg, IL 60173 - USA
Phone: +1 847 490 4270
Fax: +1 847 490 4206
e-mail: info@elau.com
Internet: www.elau.com

ELAU SYSTEMS ITALIA S.r.l.

Via Speranza, 48/A
I-40068 San Lazzaro Di Savena (BO)
Phone: +39 051 / 7818 70
Fax: +39 051 / 7818 69
e-mail: info@elau.it
Internet: www.elau.it



NOTE

You can find further contact addresses on the ELAU homepage (www.elau.de).

10.2 Further Literature

ELAU can provide you with these manuals and instructions on the PacDrive™ System:¹

Project Manual

Art.No. 17 13 00 58 - 00x (DE, EN, FR)

Programming Manual

Art.No. 17 13 00 61 - 00x (DE, EN)

Operating Manual MC-4 Servo Drive

Art.No. 17 13 00 62 - 00x (DE, EN, IT, FR)

Operating Manual CAN L2

Art.No. 17 13 00 66 - 00x (DE, EN)

Operating Manual PROFIBUS-DP

Art.No. 17 13 00 67 - 00x (DE, EN)

Operating Manual SM Motor

Art.No. 17 13 00 68 - 00x (DE, EN, IT, FR)

Operating Manual EPAS-4

Art.No. 17 13 00 70 - 00x (DE, EN)

Operating Manual PacDrive Controller MAX-4

Art.No. 17 13 00 71 - 00x (DE, EN, IT, FR)

Operating Manual OPC-Server

Art.No. 17 13 00 73 - 00x (DE, EN)

Operating Manual Device Net

Art.No. 17 13 00 76 - 00x (DE, EN)

Operating Manual HMI Libraries

Art.No. 17 13 00 77 - 00x (DE, EN)

Operating Manual INC-4 Incremental Encoder Module

Art.No. 17 13 00 78 - 00x (DE, EN)

Operating Manual CANopen

Art.No. 17 13 00 79 - 00x (DE, EN)

Operating Manual VarioCam® Editor ECAM-4

Art.No. 17 13 00 80 - 00x (DE, EN)

Operating Manual PacNet Module PN-4

Art.No. 17 13 00 81 - 00x (DE, EN)

Operating Manual SR Motor

Art.No. 17 13 00 82 - 00x (DE, EN)

1. Art.No. -000 (DE) german -001 (EN) english -002 (IT) italian -003 (FR) french

Operating Manual BusTerminal BT-4/DIO1

Art.No. 17 13 00 83 - 00x (DE, EN)

Operating Manual TTS

Art.No. 17 13 00 88 - 00x (DE)

User Manual Automatic Controller Optimization

Art.No. 17 13 00 89 - 00x (DE, EN)

Operating Manual PacDrive SCL

Art.No. 17 13 00 93 - 00x (DE, EN)

Operating Manual PacDrive PS-4 und PacDrive PD-8

Art.No. 17 13 00 94 - 00x (DE, EN)

Operating Manual Evaluation Kit

Art.No. 17 13 00 95 - 00x (DE)

Operating Manual PacDrive Controller P600

Art.No. 17 13 00 96 - 00x (DE, EN, FR)

Operating Manual PacDrive Controller C200

Art.No. 17 13 00 97 - 00x (DE, EN, FR)

Operating Manual PacDrive Controller C400

Art.No. 17 13 00 98 - 00x (DE, EN, FR)

Operating Manual PacDrive Controller C600

Art.No. 17 13 00 99 - 00x (DE, EN, FR)

Operating Manual PacDrive SH-Motor

Art.No. 17 13 01 05- 00x (DE, EN)

10.3 Product Training

We offer practical workshops and seminars.

Our experienced seminar leaders will enable you to make optimum use of the vast possibilities of the PacDrive™ system.



NOTE

Please contact us for further information or to order our seminar program. See also our homepage (www.elau.de).

7.4 Declaration by the manufacturer

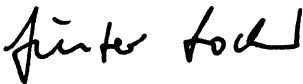
	Herstellereklärung / Declaration by the manufacturer / Déclaration du fabricant		ELN 118-02/01.01 Page 1/1
<p>Produkt: Motorcontroller</p> <p>MC-4 / 11 / 01 MC-4 / 11 / 03 MC-4 / 11 / 05 MC-4 / 11 / 10 MC-4 / 11 / 22 MC-4 / 11 / 50</p> <p>Der Hersteller erklärt, dass das gelieferte Produkt in Übereinstimmung mit den angewendeten harmonisierten Normen / Spezifikationen hergestellt worden ist.</p> <p>Angewendete harmonisierte Normen:</p> <p>EN 60204-1 (11/1998) Sicherheit von Maschinen - elektrische Ausrüstung</p> <p>EN 50081-2 (3/1994) Fachgrundnorm für die Störaussendung</p> <p>EN 61000-6-2 (3/2000) Fachgrundnorm Störfestigkeit</p> <p>Hersteller: ELAU AG Dillberg 12 D-97828 Marktheidenfeld</p> <p>Stellung im Betrieb / Position: Vorstand/Chairman</p> <p></p> <p>18.1.2001 Günter Locherer (Datum, Date / Unterschrift, Signature)</p>	<p>product: Motorcontroller</p> <p>MC-4 / 11 / 01 MC-4 / 11 / 03 MC-4 / 11 / 05 MC-4 / 11 / 10 MC-4 / 11 / 22 MC-4 / 11 / 50</p> <p>The manufacturer declares that the product delivered has been manufactured in accordance with the stated harmonized standards / specifications.</p> <p>Applied harmonized standards:</p> <p>EN 60204-1 (11/1998) Safety of machines - electrical equipment</p> <p>EN 50081-2 (3/1994) generic standard for noisy emission</p> <p>EN 61000-6-2 (3/2000) generic standard interference-resistant</p> <p>Manufacturer: ELAU AG Dillberg 12 D-97828 Marktheidenfeld</p>	<p>produit: Motorcontroller</p> <p>MC-4 / 11 / 01 MC-4 / 11 / 03 MC-4 / 11 / 05 MC-4 / 11 / 10 MC-4 / 11 / 22 MC-4 / 11 / 50</p> <p>Le fabricant déclare que le produit livré ont été fabriqués conformément a indiqués standards / spécifications harmonisés.</p> <p>Harmonisée standards appliqués:</p> <p>EN 60204-1 (11/1998) Sécurité des machines-équipement électrique</p> <p>EN 50081-2 (3/1994) norme générique pour l'émission brouillée</p> <p>EN 61000-6-2 (3/2000) norme générique résistance au brouillage</p> <p>Fabricant: ELAU AG Dillberg 12 D-97828 Marktheidenfeld</p>	

7.5 Safety Checks

For the MotorController MC-4 manufacturing the following security examinations are executed under EN 50178 / EN 60204-1:

Check for continuous connection of the protective grounding system

with 30 A

Insulation resistance check

with $U = 500 \text{ V DC}$

Tension strain check

with $U = 2500 \text{ V DC}$

for a time period of 1 min.

7.6 Hard-/Software Compatibility list

FW-Family	HW-Code			
	smaller Bxxxxx	Bxxxxx	Cxxxxx	Exxxxx
V05	V00.05.xx	from V00.05.20	from V00.05.22	from V00.05.31
V07	V00.07.xx	from V00.07.20	from V00.07.22	from V00.07.31
V10	V00.10.xx	from V00.10.20	from V00.10.22	from V00.10.31
V11	V00.11.xx	from V00.11.20	from V00.11.22	from V00.11.31
V12	V00.12.xx	from V00.12.01	from V00.12.02	from V00.12.31
V15	V00.15.xx	V00.15.xx	V00.15.xx	from V00.15.31
V16	V00.16.xx	V00.16.xx	V00.16.xx	V00.16.xx
V20	V00.20.xx	V00.20.xx	V00.20.xx	V00.20.xx
...

Fig. 7-1: PacDrive MC-4 Hard- and Software compatibility

7.7 Modifications

01 / 1999

- Operating Manual newly written

07 / 1999

- Terms such as MAx-4, MC-4 and PacDrive™ M adjusted
- Sales regions updated

12 / 1999

- Structure of the document modified
- Description of the 22 A MC-4 improved

01 / 2001

- MC-4 / 50 / 400 new
- Mains filter HLD 110-500/55 new
- Various errors cleared and improvements made

08 / 2004

- Included new mains filter series
- Over-worked the structure of the document
- Various errors cleared and improvements made
- Adjusted product names and terms

05 / 2005

- Included new chapter „Mains Choke“

12/ 2005

- MC-4 / 1.5 A



NOTE

The latest documentation and modification service on this product are available on the ELAU Homepage (<http://www.elau.de>).

7.8 Index

A

Approbationen
 MC-4 / 05 A 41, 42, 43, 44,
 45
 MC-4 / 1,5 A 40
 Automation System 17

C

cleaning 27
 commissioning 30
 Concept 18
 configuration 32
 connections
 BM-4 58, 59, 60
 MC-4 47, 48
 contact 67
 contact addresses 67
 contents 3

D

diagnosis 21
 dimensions
 BM-4 61
 mains filter 63, 64
 MC-4 53

E

ELAU AG 2
 eMail
 ELAU AG 2
 EMC rules 28
 error report 77
 exchanging units 25
 cable 27
 motor 25

F

forms of depiction 6

G

Gerätetausch
 Motor tauschen 25

H

homepage
 ELAU AG 2

I

imprint 2
 internet
 ELAU AG 2

L

literature 68

M

maintenance 23
 manuals 68
 Modifications 74

O

operating manual 68
 order numbers 35
 accessories 38
 cable 36
 MC-4 35

P

Packaging machine 15
 Pictograph 8
 programming 32
 Programming Manual 68

R

repair 24, 67
 risk
 classification 8

S

safety notes 8
 seminare 70
 service
 -personnel 67
 service addresses 24
 spare parts 23
 storage 21
 Structure 17
 symbols, signs 6
 System 15

T

trademarks 2
 training 70

transportation 21
type plate 22

U

unpacking 22
Use as directed 9

10.8 Form for Error Report

This error report is absolutely necessary in order to enable efficient processing.

Send the error report to your ELAU representative or to:

ELAU AG, Abt. Kundendienst
Dillberg 12, D-97828 Marktheidenfeld
Fax: +49 (0) 93 91 / 606 - 340

Sender:

Company:	City:	Date:
Department:	Name:	Phone:

Details of the defective product

Product name:
Article number:
Serial number:
Software version:
Hardware code:

Parameter enclosed: yes [] no []

IEC program enclosed: yes [] no []

Details of the machine on which the problem occurred:

Machine producer:
Type:
Hours of operation:
Machine number:
Date of commissioning:
Producer/Type of machine control:
.....

